



ELATECH, società del gruppo SIT, è specializzata nella progettazione, produzione e sviluppo di cinghie in poliuretano.

I moderni mezzi di produzione, l'avanzato reparto prove ed un affiatato team di ingegneri e tecnici, permettono di offrire una vasta gamma di prodotti che soddisfano ogni esigenza nel campo della trasmissione lineare, trasporto, sollevamento o trasmissione di potenza.

La combinazione delle cinghie in poliuretano coi prodotti fabbricati nello stabilimento SIT quali pulegge, giunti, piastre di bloccaggio e gli esclusivi accessori, ci permettono di porci come partner ideale per la fornitura completa di trasmissioni di qualità in ogni settore merceologico.

ELATECH is a Company of SIT group fully dedicated to the research, development and manufacture of polyurethane belts for industrial applications.

The unique manufacturing processes, realized with the newest generation technologies, the modern and efficient test and control equipments and a unique team of qualified technicians and engineers, allow SIT to offer a wide range of superior products with the highest flexible service. The combination of the polyurethane belts with the range of metal accessories such as timing pulleys, couplings, locking devices, clamping plates produced in our factory, allow our engineering department to deliver innovative and unique solutions to even the most complex requirements in drive technology, linear motion, conveying or lifting applications.



Introduction

ELATECH® manufactures polyurethane belts for linear motion, conveying and power transmission applications. The combination of a polyurethane body reinforced with special steel or aramid tension members, makes the belt to fulfil the most severe requirements in all industrial applications.

The unique manufacturing processes, realized with the newest generation technologies, the modern and efficient test and control equipment, allow delivering superior products with the highest flexible service.

ELATECH® offers the widest range of tooth profile to enable the design engineer the use of the best drive for every application.

In addition to that, for special applications, ELATECH® studies and delivers innovative and unique solutions to even the most complex requirements.

Product range

ELATECH® M - open end

ELATECH® M belts are produced in standard roll length of 100 m and delivered to any desired length. The excellent precision and dimensional stability, the high abrasion resistance make them ideal in all linear motion applications.

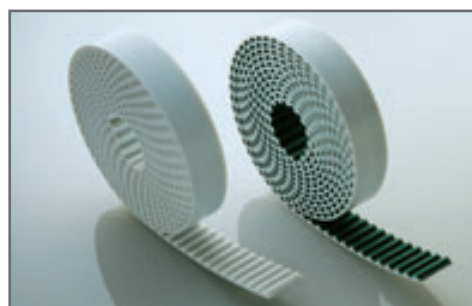

ELATECH® V - jointed

They are jointed belts obtained from open-end belts. The special manufacturing process, allows obtaining any desired length. Due to the high flexibility and to the unique precision in positioning offered, ELATECH V belts are ideal for all conveying applications where synchronisation is needed.



ELA-flex SD™

ELA-flex SD™ Synchro Drive belts are manufactured with truly endless steel tension cords. Having no splice or welding, they have no weak cross section and are therefore ideal for power transmission and high load conveying applications. They are available in a wide range of profiles and pitches and in any length tooth by tooth from 1500 mm to 22000 mm.

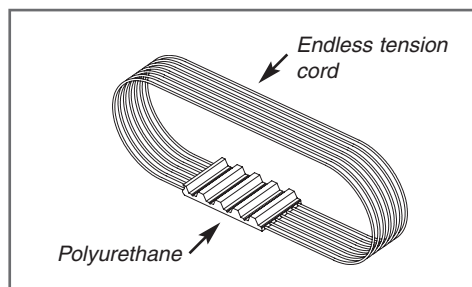

ELATECH® M and V

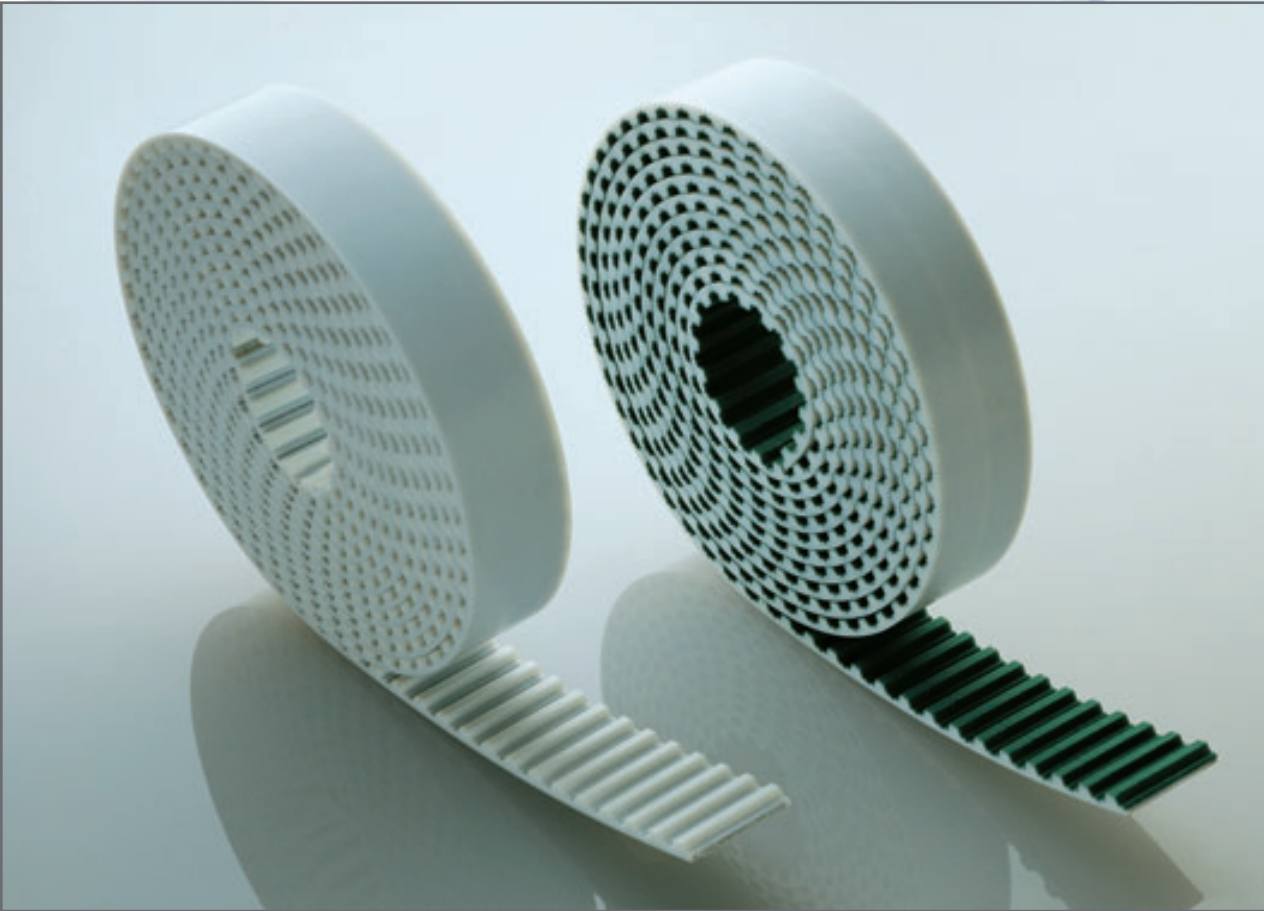

Introduction

The timing belts manufactured by ELATECH® have been designed to comply to every need of the design engineer in linear motion, power transmission and in conveying applications where precise synchronisation is needed. ELATECH® timing belts are manufactured with the body in thermoplastic polyurethane with excellent wear resistance and with high tensile strength steel cords. A special polyamide fabric on the tooth (on request) reduces the coefficient of friction, improves the tooth engagement and reduces noise.

Standard belt

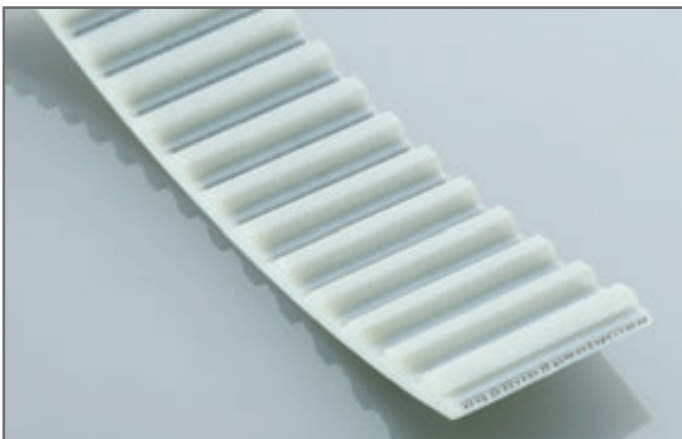

Belt with Polyamide fabric on teeth PAZ

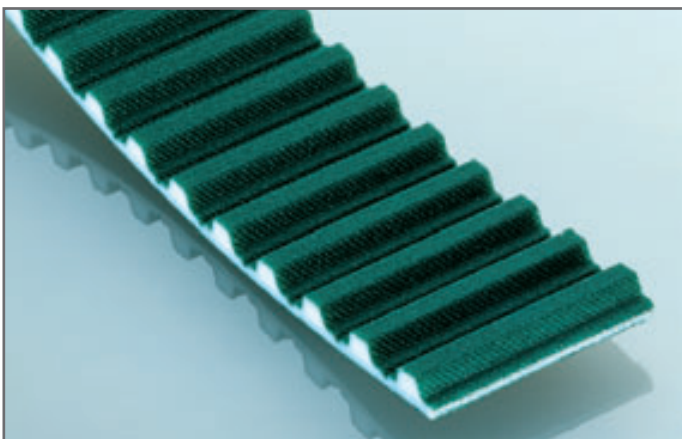

Tension Cords

In order to maximize the application of ELATECH® timing belts, construction with special cords is available on request:



- HPL high performance cords: the cord cross section is increased compared with standard. This results in a lower belt elongation and more precise positioning accuracy.
- HFE high Flexibility cords: the cord cross section is spread on a higher number of single filaments. This results in a lower bending stress and therefore in a higher resistance at reverse bending of the cords. They allow using pulleys and idlers up to 30% smaller in diameter compared to standard.
- INOX stainless steel cords are suitable for application in aggressive environments. They have lower tensile strength than standard cords.
- Aramid: increases belt flexibility and decreases belt weight.

It is to be noted that steel cords offer the best technical performances and dimensional stability of the belts.

For application with special cords ask our engineering department.

Product certification

- ELATECH® belts are certified to be according RoHS 2002/95/EC
- On request, it is possible to deliver belts according to:
 - 94/9/CE ATEX II2G-22D
 - Antistatic according to ISO 9563 (with special fabric)

Colour

ELATECH® timing belts are produced as standard in white colour. On demand it is possible to deliver belts in different colours.

Mechanical properties:

- Excellent dimensional stability
- High abrasion resistance
- Low pretension and shaft load
- Maintenance free
- High linear and angular positioning precision
- High efficiency

Chemical properties:

High resistance to:

- Hydrolysis
- Ozone
- UVA
- Ageing
- Oils, greases and fats
- Gasoline
- Good resistance to acids
- Working temperatures range -10°C +80°C (peaks up to 110°C)
For very low temperature special compound material is available on request.
- Silicon free production

Executions

ELATECH® M

They are manufactured in rolls with standard length of 100 m. On request longer or shorter lengths are available. Main applications are linear drives.

Ordering example T :

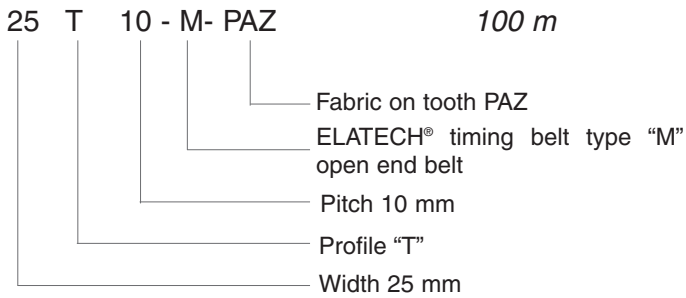

Ordering example H :

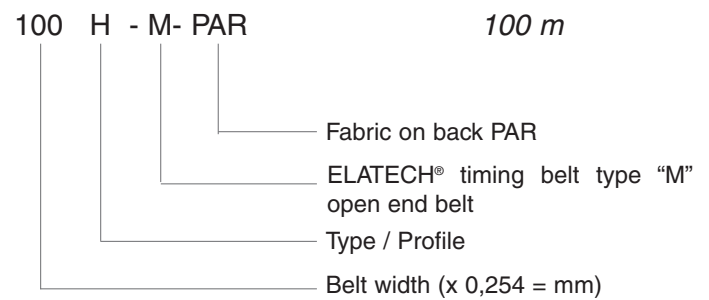

Ordering example HTD cut to length:

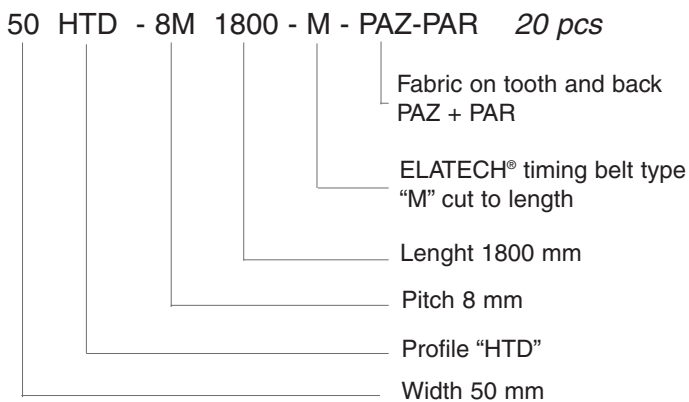

Ordering example H cut to length:

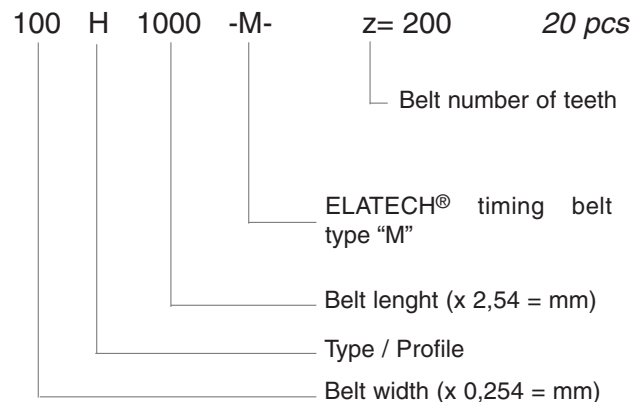

ELATECH® V

They are jointed belts manufactured from open-end ELATECH® belts. Thanks to the specific manufacturing process, any length may be obtained tooth by tooth with a minimum of 800 mm length. Free combinations with special backing materials and welded profiles, make ELATECH® V belts ideal in synchronized conveying and highly specialised applications.

Ordering example AT :

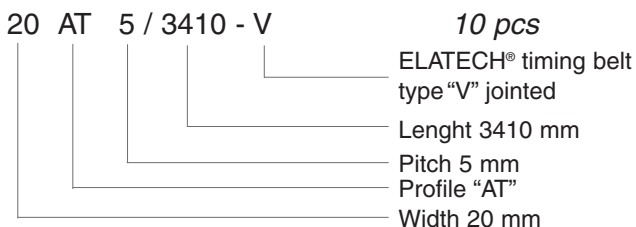

Ordering example XL :

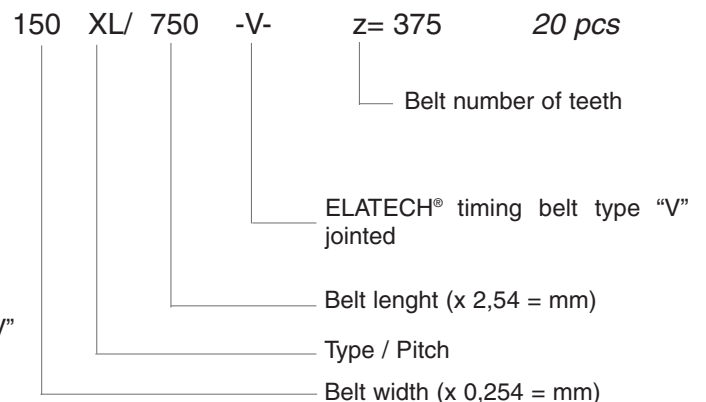

Ordering example STD :

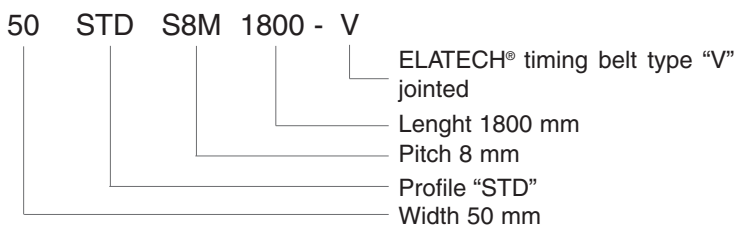

T2,5

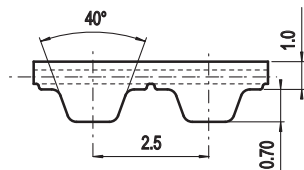

Belt characteristics

- Polyurethane timing belt with steel tension cords
- Trapezoidal tooth profile according to DIN 7721 T1
- Metric pitch 2,5 mm
- Ideal for drives where high belt flexibility is requested
- Widely used for conveying, linear drive and light power transmission applications
- Color: white

- Width tolerance: $\pm 0,5$ [mm]
- Length tolerance: $\pm 0,5$ [mm/m]
- Thickness tolerance: $\pm 0,2$ [mm]

Technical data

Belt width b [mm]	Allowable tensile load Type M F_{Tzul} [N]	Allowable tensile load Type V F_{Tzul} [N]	Breaking load Type M F_{Br} [N]	Specific spring rate C_{spez} [N]	Weight [kg/m]
4	100	50	500375	25000	0,004
6	190	95	750	47500	0,007
10	320	160	1250	80000	0,011
20	700	350	2750	175000	0,022
50	1860	930	7250	465000	0,055
100	3780	1890	14750	945000	0,110

Load / Elongation [%]

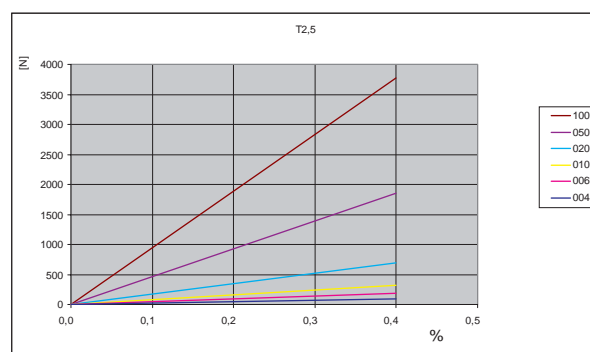

Other widths are available on request.

Tooth shear strength

rpm	F_{Uspez} [N/cm]	rpm	F_{Uspez} [N/cm]	rpm	F_{Uspez} [N/cm]	rpm	F_{Uspez} [N/cm]
0	12,35	800	8,51	1900	7,11	4500	5,63
20	12,04	900	8,33	2000	7,02	5000	5,44
40	11,77	1000	8,16	2200	6,86	5500	5,28
60	11,53	1100	8,01	2400	6,71	6000	5,12
80	11,32	1200	7,87	2600	6,57	6500	4,98
100	11,14	1300	7,74	2800	6,45	7000	4,85
200	10,45	1400	7,61	3000	6,33	7500	4,73
300	9,95	1440	7,57	3200	6,22	8000	4,62
400	9,55	1500	7,50	3400	6,11	8500	4,51
500	9,23	1600	7,39	3600	6,02	9000	4,41
600	8,96	1700	7,29	3800	5,92	9500	4,31
700	8,72	1800	7,20	4000	5,83	10000	4,22

Tooth shear strength / rpm

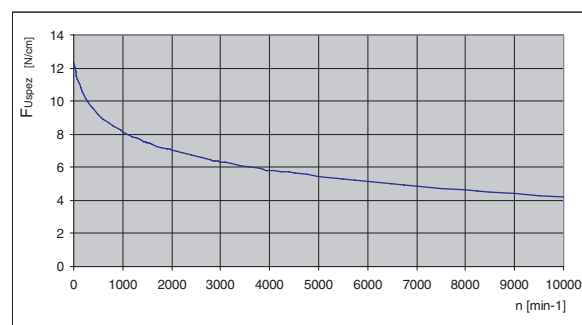

The specific load F_{Uspez} is the maximum load which one single belt tooth 1 cm wide can withstand in all operating conditions. This force is related to the drive rpm. The total load F_U transmissible by the belt in the drive is calculated by:

$$F_U [N] = F_{Uspez} \cdot z_e \cdot b$$

- F_U [N] = peripheral force
- F_{Uspez} [N/cm] = specific load
- z_e = number of teeth in mesh in the small pulley
- z_{emax} = max. no of teeth in mesh to be considered for the calculation of the drive
- $z_{emax} = 12$ for ELATECH® M
- $z_{emax} = 6$ for ELATECH® V
- b [cm] = belt width in cm

Flexibility

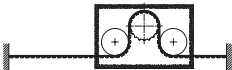
Minimum pulley number of teeth and minimum idler diameter		
T2,5		TYPE OF CORD
		STANDARD
Drive without reverse bending 	Timing pulley z_{min}	10
	Idler running on belt teeth d_{min}	30 mm
Drive with reverse bending 	Timing pulley z_{min}	15
	Idler running on belt back d_{min}	30 mm

Timing pulleys

z	da	dw	z	da	dw	z	da	dw	z	da	dw
10	7,46	7,96	43	33,72	34,22	76	59,98	60,48	109	86,24	86,74
11	8,25	8,75	44	34,52	35,02	77	60,78	61,28	110	87,04	87,54
12	9,05	9,55	45	35,31	35,81	78	61,57	62,07	111	87,83	88,33
13	9,85	10,35	46	36,11	36,61	79	62,37	62,87	112	88,63	89,13
14	10,64	11,14	47	36,90	37,40	80	63,16	63,66	113	89,43	89,93
15	11,44	11,94	48	37,70	38,20	81	63,96	64,46	114	90,22	90,72
16	12,23	12,73	49	38,49	38,99	82	64,76	65,26	115	91,02	91,52
17	13,03	13,53	50	39,29	39,79	83	65,55	66,05	116	91,81	92,31
18	13,82	14,32	51	40,09	40,59	84	66,35	66,85	117	92,61	93,11
19	14,62	15,12	52	40,88	41,38	85	67,14	67,64	118	93,40	93,90
20	15,42	15,92	53	41,68	42,18	86	67,94	68,44	119	94,20	94,70
21	16,21	16,71	54	42,47	42,97	87	68,73	69,23	120	95,00	95,50
22	17,01	17,51	55	43,27	43,77	88	69,53	70,03	121	95,79	96,29
23	17,80	18,30	56	44,06	44,56	89	70,33	70,83	122	96,59	97,09
24	18,60	19,10	57	44,86	45,36	90	71,12	71,62	123	97,38	97,88
25	19,39	19,89	58	45,66	46,16	91	71,92	72,42	124	98,18	98,68
26	20,19	20,69	59	46,45	46,95	92	72,71	73,21	125	98,97	99,47
27	20,99	21,49	60	47,25	47,75	93	73,51	74,01	126	99,77	100,27
28	21,78	22,28	61	48,04	48,54	94	74,31	74,81	127	100,57	101,07
29	22,58	23,08	62	48,84	49,34	95	75,10	75,60	128	101,36	101,86
30	23,37	23,87	63	49,64	50,14	96	75,90	76,40	129	102,16	102,66
31	24,17	24,67	64	50,43	50,93	97	76,69	77,19	130	102,95	103,45
32	24,97	25,47	65	51,23	51,73	98	77,49	77,99	131	103,75	104,25
33	25,76	26,26	66	52,02	52,52	99	78,28	78,78	132	104,55	105,05
34	26,56	27,06	67	52,82	53,32	100	79,08	79,58	133	105,34	105,84
35	27,35	27,85	68	53,61	54,11	101	79,88	80,38	134	106,14	106,64
36	28,15	28,65	69	54,41	54,91	102	80,67	81,17	135	106,93	107,43
37	28,94	29,44	70	55,21	55,71	103	81,47	81,97	136	107,73	108,23
38	29,74	30,24	71	56,00	56,50	104	82,26	82,76	137	108,52	109,02
39	30,54	31,04	72	56,80	57,30	105	83,06	83,56	138	109,32	109,82
40	31,33	31,83	73	57,59	58,09	106	83,85	84,35	139	110,12	110,62
41	32,13	32,63	74	58,39	58,89	107	84,65	85,15	140	110,91	111,41
42	32,92	33,42	75	59,18	59,68	108	85,45	85,95			

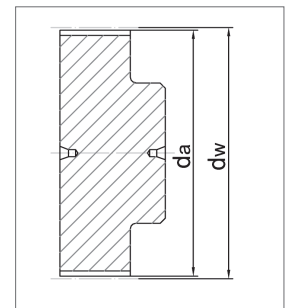

T5

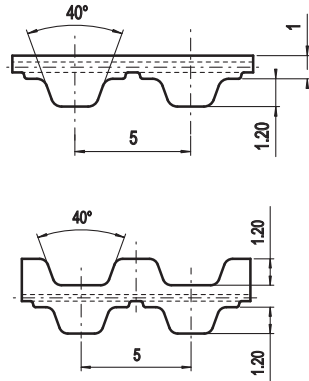

Belt characteristics

- Polyurethane timing belt with steel tension cords
- Trapezoidal tooth profile according to DIN 7721 T1
- Metric pitch 5 mm
- Ideal for drives where high belt flexibility is requested
- Widely used for conveying, linear drive and light power transmission applications
- Double sided tooth construction available

- Width tolerance: $\pm 0,5$ [mm]
- Length tolerance: $\pm 0,5$ [mm/m]
- Thickness tolerance: $\pm 0,2$ [mm]

Technical data

Belt width b [mm]	Allowable tensile load Type M F_{Tzul} [N]	Allowable tensile load Type V F_{Tzul} [N]	Breaking load Type M F_{Br} [N]	Specific spring rate C_{spez} [N]	Weight [kg/m]
10	320	160	1250	80000	0,021
16	540	270	2125	135000	0,034
25	900	450	3500	225000	0,053
32	1150	575	4500	287500	0,067
50	1860	930	7250	465000	0,105
75	2820	1410	11000	705000	0,158
100	3780	1890	14750	945000	0,210

Load / Elongation [%]

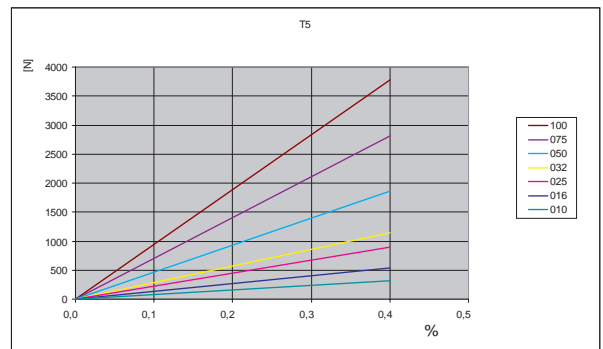

Other widths are available on request.

Tooth shear strength

rpm	F_{Uspez} [N/cm]	rpm	F_{Uspez} [N/cm]	rpm	F_{Uspez} [N/cm]	rpm	F_{Uspez} [N/cm]
0	24,70	800	17,02	1900	14,21	4500	11,25
20	24,07	900	16,65	2000	14,03	5000	10,88
40	23,53	1000	16,32	2200	13,71	5500	10,55
60	23,05	1100	16,01	2400	13,42	6000	10,24
80	22,64	1200	15,73	2600	13,14	6500	9,96
100	22,28	1300	15,47	2800	12,89	7000	9,70
200	20,90	1400	15,22	3000	12,65	7500	9,46
300	19,89	1440	15,13	3200	12,43	8000	9,23
400	19,10	1500	15,00	3400	12,22	8500	9,01
500	18,45	1600	14,78	3600	12,03	9000	8,81
600	17,91	1700	14,58	3800	11,84	9500	8,62
700	17,44	1800	14,39	4000	11,66	10000	8,44

Tooth shear strength / rpm

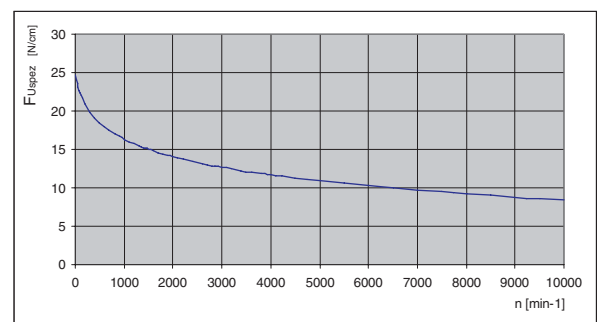

The specific load F_{Uspez} is the maximum load which one single belt tooth 1 cm wide can withstand in all operating conditions. This force is related to the drive rpm. The total load F_U transmissible by the belt in the drive is calculated by:

$$F_U [N] = F_{Uspez} \cdot z_e \cdot b$$

- $F_U [N]$ = peripheral force
- $F_{Uspez} [N/cm]$ = specific load
- z_e = number of teeth in mesh in the small pulley
- z_{emax} = max. no of teeth in mesh to be considered for the calculation of the drive
- $z_{emax} = 12$ for ELATECH® M
- $z_{emax} = 6$ for ELATECH® V
- $b [cm]$ = belt width in cm

Specialties

PROFILE	Belt width b [mm]	ARAMID CORD	
		F _{Tzul} [N] M type	F _{Br} [N]
T5	010	840	3.360
	016	1.190	4.760
	025	1.960	7.840
	032	2.520	10.080
	050	4.060	16.240
	075	6.160	24.640
	100	8.260	33.040

Flexibility

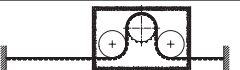
Minimum pulley number of teeth and minimum idler diameter			
T5		TYPE OF CORD	
		STANDARD	ARAMID
Drive without reverse bending 	Timing pulley z _{min}	10	12
	Idler running on belt teeth d _{min}	30 mm	30 mm
Drive with reverse bending 	Timing pulley z _{min}	15	15
	Idler running on belt back d _{min}	30 mm	30 mm

Timing pulleys

z	da	dw	z	da	dw	z	da	dw	z	da	dw
10	15,05	15,92	39	61,25	62,09	68	107,40	108,26	97	153,55	154,42
11	16,65	17,51	40	62,85	63,66	69	109,00	109,85	98	155,15	156,02
12	18,25	19,10	41	64,40	65,27	70	110,60	111,44	99	156,75	157,61
13	19,85	20,70	42	66,00	66,86	71	112,20	113,03	100	158,35	159,20
14	21,45	22,29	43	67,70	68,46	72	113,75	114,62	101	159,95	160,79
15	23,05	23,88	44	69,20	70,05	73	115,35	116,22	102	161,55	162,38
16	24,60	25,47	45	70,80	71,64	74	116,95	117,81	103	163,10	163,97
17	26,20	27,06	46	72,40	73,23	75	118,55	119,40	104	164,70	165,57
18	27,80	28,65	47	73,95	74,82	76	120,15	120,99	105	166,30	167,16
19	29,40	30,25	48	75,55	76,42	77	121,75	122,58	106	167,90	168,75
20	31,00	31,83	49	77,15	78,01	78	123,30	124,18	107	169,50	170,34
21	32,70	33,43	50	78,75	79,60	79	124,90	125,77	108	171,10	171,94
22	34,25	35,02	51	80,35	81,19	80	126,50	127,36	109	172,65	173,53
23	35,85	36,62	52	81,95	82,78	81	128,10	128,95	110	174,25	175,12
24	37,40	38,21	53	83,50	84,38	82	129,70	130,54	111	175,85	176,71
25	39,00	39,80	54	85,10	85,97	83	131,30	132,14	112	177,45	178,30
26	40,60	41,39	55	86,70	87,54	84	132,85	133,73	113	179,05	179,84
27	42,20	42,98	56	88,30	89,15	85	134,45	135,32	114	180,65	181,49
28	43,75	44,58	57	89,90	90,74	86	136,05	136,91	115	182,23	183,08
29	45,35	46,17	58	91,50	92,34	87	137,65	138,50	116	183,82	184,67
30	46,95	47,76	59	93,05	93,93	88	139,25	140,10	117	185,42	186,26
31	48,55	49,35	60	94,65	95,52	89	140,85	141,69	118	187,01	187,86
32	50,10	50,94	61	96,25	97,11	90	142,45	143,28	119	188,61	189,45
33	51,70	52,54	62	97,85	98,70	91	144,00	144,87	120	190,21	191,04
34	53,25	54,13	63	99,45	100,30	92	145,60	146,46			
35	54,85	55,72	64	101,05	101,89	93	147,20	148,06			
36	56,45	57,31	65	102,65	103,48	94	148,80	149,65			
37	58,05	58,90	66	104,20	105,07	95	150,40	151,24			
38	59,65	60,50	67	105,80	106,66	96	152,00	152,83			

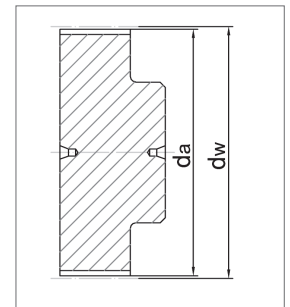

T10

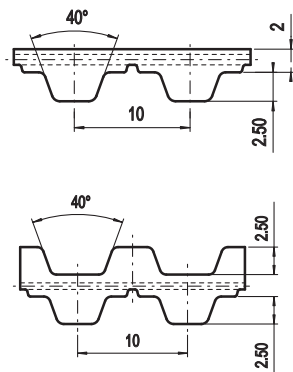

Belt characteristics

- Polyurethane timing belt with steel tension cords
- Trapezoidal tooth profile according to DIN 7721 T1
- Metric pitch 10 mm
- Ideal for drives where high belt flexibility is requested
- Widely used for conveying, linear drive and medium power transmission applications
- Double sided tooth construction available

- Width tolerance: $\pm 0,5$ [mm]
- Length tolerance: $\pm 0,5$ [mm/m]
- Thickness tolerance: $\pm 0,2$ [mm]

Technical data

Belt width b [mm]	Allowable tensile load Type M F _{Tzul} [N]	Allowable tensile load Type V F _{Tzul} [N]	Breaking load Type M F _{Br} [N]	Specific spring rate C _{spez} [N]	Weight [kg/m]
10	920	460	3360	230000	0,05
16	1610	805	5880	402500	0,07
25	2650	1325	9660	662500	0,11
32	3450	1725	12600	862500	0,15
50	5520	2760	20160	1380000	0,23
75	8400	4200	30660	2100000	0,34
100	11270	5635	41160	2817500	0,45
150	17020	8510	62160	4255000	0,68
200	11270	5635	41160	2817500	0,60

Load / Elongation [%]

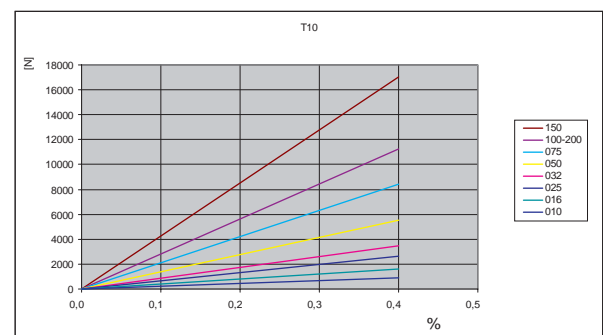

Other widths are available on request.

Tooth shear strength

rpm	F _{Uspez} [N/cm]	rpm	F _{Uspez} [N/cm]	rpm	F _{Uspez} [N/cm]	rpm	F _{Uspez} [N/cm]
0	51,80	800	33,34	1900	26,53	4500	19,40
20	50,32	900	32,44	2000	26,12	5000	18,51
40	49,04	1000	31,63	2200	25,34	5500	17,70
60	47,92	1100	30,89	2400	24,63	6000	16,97
80	46,95	1200	30,21	2600	23,97	6500	16,29
100	46,11	1300	29,58	2800	23,36	7000	15,66
200	42,75	1400	28,99	3000	22,78	7500	15,07
300	40,28	1440	28,76	3200	22,25	8000	14,52
400	38,36	1500	28,44	3400	21,74	8500	14,00
500	36,80	1600	27,92	3600	21,27	9000	13,51
600	35,49	1700	27,43	3800	20,81	9500	13,05
700	34,35	1800	26,97	4000	20,39	10000	12,61

Tooth shear strength / rpm

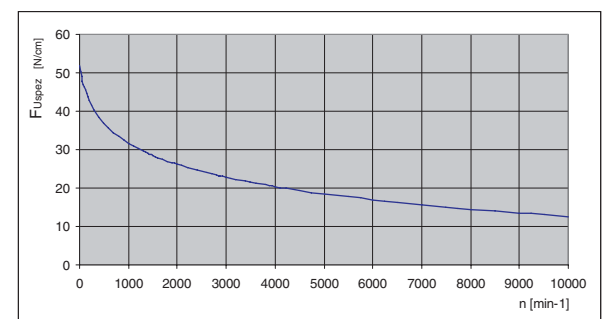

The specific load F_{Uspez} is the maximum load which one single belt tooth 1 cm wide can withstand in all operating conditions. This force is related to the drive rpm. The total load F_U transmissible by the belt in the drive is calculated by:

$$F_U [N] = F_{Uspez} \cdot z_e \cdot b$$

- F_U [N] = peripheral force
- F_{Uspez} [N/cm] = specific load
- z_e = number of teeth in mesh in the small pulley
- z_{emax} = max. no of teeth in mesh to be considered for the calculation of the drive
- z_{emax} = 12 for ELATECH® M
- z_{emax} = 6 for ELATECH® V
- b [cm] = belt width in cm

Specialties

PROFILE	Belt width b [mm]	ARAMID CORD		STAINLESS STEEL		HPL High performance		HFE High flexibility	
		F _{Tzul} [N] M type	F _{Br} [N]	F _{Tzul} [N] M type	F _{Br} [N]	F _{Tzul} [N] M type	F _{Br} [N]	F _{Tzul} [N] M type	F _{Br} [N]
T10	010	880	3600	600	2400			960	3440
	016	1540	6300	1050	4200	2210	8550	1680	6020
	025	2530	10350	1730	6900	3750	14540	2760	9890
	032	3300	13500	2250	9000	4850	18810	3600	12900
	050	5280	21600	3600	14400	7720	29930	5760	20640
	075	8030	32850			11690	45320	8760	31390
	100	10780	44100			15660	60710	11760	42140
	150	16280	66600						
200	10780	44100							

Flexibility

Minimum pulley number of teeth and minimum idler diameter						
T10		TYPE OF CORD				
		STANDARD	ARAMID	STAINLESS	HPL	HFE
 Drive without reverse bending	Timing pulley z _{min}	12	15	12	15	12
	Idler running on belt teeth d _{min}	60 mm	60 mm	60 mm	100 mm	50 mm
 Drive with reverse bending	Timing pulley z _{min}	20	20	20	30	12
	Idler running on belt back d _{min}	60 mm	60 mm	60 mm	100 mm	50 mm

Timing pulleys

z	da	dw	z	da	dw	z	da	dw	z	da	dw
10	30,05	31,84	39	122,30	124,14	68	214,60	216,44	97	306,90	308,75
11	33,25	35,02	40	125,45	127,32	69	217,75	219,63	98	310,10	311,93
12	36,35	38,20	41	128,65	130,50	70	220,95	222,81	99	313,25	315,12
13	39,50	41,38	42	131,85	133,69	71	224,15	225,99	100	316,45	318,30
14	42,70	44,56	43	135,00	136,87	72	227,30	229,18	101	319,65	321,48
15	45,90	47,75	44	138,20	140,05	73	230,50	232,36	102	322,80	324,66
16	49,05	50,93	45	141,40	143,24	74	233,70	235,54	103	326,00	327,85
17	52,25	54,11	46	144,60	146,42	75	236,90	238,72	104	329,20	331,03
18	55,45	57,29	47	147,75	149,60	76	240,05	241,94	105	332,35	334,21
19	58,65	60,48	48	150,95	152,78	77	243,25	245,09	106	335,55	337,40
20	61,80	63,66	49	154,10	155,97	78	246,40	248,27	107	338,75	340,58
21	65,00	66,84	50	157,30	159,15	79	249,60	251,46	108	341,95	343,76
22	68,15	70,03	51	160,50	162,33	80	252,80	254,64	109	345,15	346,95
23	71,35	73,20	52	163,65	165,52	81	256,00	257,82	110	348,30	350,13
24	74,55	76,39	53	166,85	168,70	82	259,15	261,00	111	351,45	353,31
25	77,70	79,58	54	170,05	171,88	83	262,30	264,19	112	354,65	356,50
26	80,90	82,76	55	173,20	175,06	84	265,50	267,37	113	357,80	359,68
27	84,10	85,95	56	176,40	178,25	85	268,70	270,55	114	361,00	362,86
28	87,25	89,12	57	179,60	181,43	86	271,90	273,74	115	364,19	366,04
29	90,45	92,21	58	182,75	184,61	87	275,05	276,92	116	367,39	369,23
30	93,65	95,49	59	185,95	187,80	88	278,25	280,10	117	370,56	372,41
31	96,85	98,67	60	189,10	190,98	89	281,45	283,28	118	373,76	375,59
32	100,00	101,86	61	192,30	194,16	90	284,60	286,47	119	376,93	378,78
33	103,20	105,04	62	195,50	197,35	91	287,80	289,65	120	380,11	381,96
34	106,40	108,22	63	198,65	200,53	92	291,00	292,84			
35	109,55	111,41	64	201,85	203,71	93	294,20	296,02			
36	112,75	114,59	65	205,05	206,90	94	297,35	299,20			
37	115,90	117,77	66	208,20	210,08	95	300,55	302,39			
38	119,10	120,95	67	211,40	213,26	96	303,75	305,57			

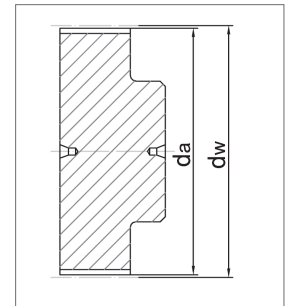

T20

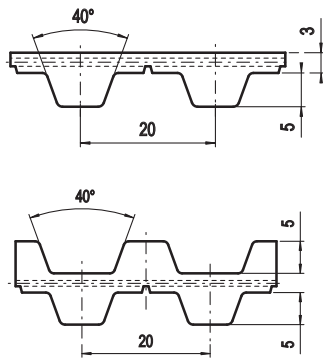

Belt characteristics

- Polyurethane timing belt with steel tension cords
- Trapezoidal tooth profile according to DIN 7721 T1
- Metric pitch 20 mm
- Ideal for drives where high belt flexibility is requested
- Widely used for conveying, linear drive and heavy power transmission applications
- Double sided tooth construction available

- Width tolerance: $\pm 1,0$ [mm]
- Length tolerance: $\pm 0,5$ [mm/m]
- Thickness tolerance: $\pm 0,4$ [mm]

Technical data

Belt width b [mm]	Allowable tensile load Type M F_{Tzul} [N]	Allowable tensile load Type V F_{Tzul} [N]	Breaking load Type M F_{Br} [N]	Specific spring rate C_{spez} [N]	Weight [kg/m]
25	4170	2085	16150	1042500	0,18
32	5390	2695	20900	1347500	0,24
50	8580	4290	33250	2145000	0,37
75	12990	6495	50350	3247500	0,55
100	17400	8700	67450	4350000	0,73
150	25480	12740	98800	6370000	1,10

Load / Elongation [%]

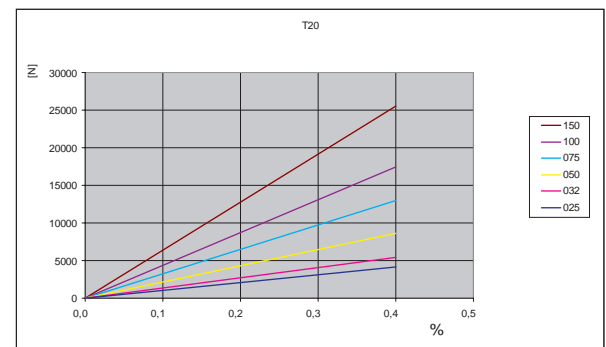

Other widths are available on request.

Tooth shear strength

rpm	F_{Uspez} [N/cm]	rpm	F_{Uspez} [N/cm]	rpm	F_{Uspez} [N/cm]	rpm	F_{Uspez} [N/cm]
0	104,50	800	62,15	1900	46,88	4500	30,92
20	101,10	900	60,13	2000	45,94	5000	28,93
40	98,15	1000	58,31	2200	44,20	5500	27,14
60	95,58	1100	56,64	2400	42,61	6000	25,49
80	93,35	1200	55,11	2600	41,13	6500	23,97
100	91,41	1300	53,70	2800	39,77		
200	83,50	1400	52,38	3000	38,49		
300	77,84	1440	51,87	3200	37,29		
400	73,49	1500	51,14	3400	36,16		
500	69,96	1600	49,98	3600	35,10		
600	66,98	1700	48,89	3800	34,09		
700	64,41	1800	47,86	4000	33,13		

Tooth shear strength / rpm

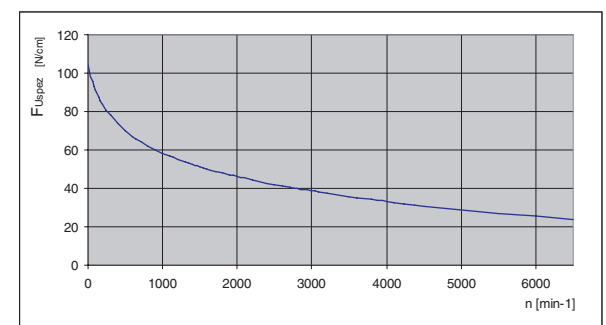

The specific load F_{Uspez} is the maximum load which one single belt tooth 1 cm wide can withstand in all operating conditions. This force is related to the drive rpm. The total load F_U transmissible by the belt in the drive is calculated by:

$$F_U [N] = F_{Uspez} \cdot z_e \cdot b$$

- $F_U [N]$ = peripheral force
- $F_{Uspez} [N/cm]$ = specific load
- z_e = number of teeth in mesh in the small pulley
- z_{emax} = max. no of teeth in mesh to be considered for the calculation of the drive
- $z_{emax} = 12$ for ELATECH® M
- $z_{emax} = 6$ for ELATECH® V
- $b [cm]$ = belt width in cm

Specialties

PROFILE	Belt width b [mm]	ARAMID CORD		STAINLESS STEEL		HFE High flexibility	
		F _{Tzul} [N] M type	F _{Br} [N]	F _{Tzul} [N] M type	F _{Br} [N]	F _{Tzul} [N] M type	F _{Br} [N]
T20	025	3230	13430	3060	12750	3400	14450
	032	4180	17380	3960	16500	4400	18700
	050	6650	27650	6300	26250	7000	29750
	075	10070	41870			10600	45050
	100	13490	56090			14200	60350
	150	19760	82160				

Flexibility

Minimum pulley number of teeth and minimum idler diameter					
T20		TYPE OF CORD			
		STANDARD	ARAMID	STAINLESS	HFE
Drive without reverse bending 	Timing pulley z _{min}	15	15	20	15
	Idler running on belt teeth d _{min}	120 mm	120 mm	130 mm	100 mm
Drive with reverse bending 	Timing pulley z _{min}	25	25	20	20
	Idler running on belt back d _{min}	120 mm	120 mm	130 mm	100 mm

Timing pulleys

z	da	dw	z	da	dw	z	da	dw	z	da	dw
15	92,65	95,49	44	277,25	280,10	73	461,85	464,73	102	646,50	649,34
16	99,00	101,86	45	283,60	286,47	74	468,25	471,08	103	652,85	655,71
17	105,40	108,22	46	289,95	292,84	75	474,60	477,45	104	659,20	662,06
18	111,75	114,59	47	296,35	299,21	76	480,95	483,82	105	665,60	668,43
19	118,10	120,96	48	302,70	305,58	77	487,35	490,19	106	671,95	674,80
20	124,50	127,32	49	309,10	311,93	78	493,70	496,56	107	678,30	681,17
21	130,75	133,69	50	315,45	318,30	79	500,05	502,91	108	684,70	687,54
22	137,20	140,06	51	321,80	324,67	80	506,45	509,28	109	691,05	693,89
23	143,55	146,43	52	328,15	331,03	81	512,80	515,65	110	697,40	700,26
24	149,95	152,78	53	334,50	337,40	82	519,15	522,02	111	703,80	706,63
25	156,30	159,15	54	340,90	343,76	83	525,55	528,39	112	710,15	712,99
26	162,65	165,52	55	347,25	350,13	84	531,90	534,74	113	716,50	719,36
27	169,00	171,89	56	353,60	356,50	85	538,25	541,11	114	722,90	725,73
28	175,40	178,25	57	360,00	362,86	86	544,60	547,48	115	729,24	732,09
29	181,75	184,62	58	366,35	369,23	87	551,00	553,85	116	735,61	738,46
30	188,10	190,99	59	372,75	375,59	88	557,35	560,22	117	741,96	744,83
31	194,50	197,35	60	379,10	381,96	89	563,70	566,57	118	748,34	751,19
32	200,85	203,72	61	385,45	388,33	90	570,10	572,94	119	754,70	757,56
33	207,20	210,09	62	391,85	394,70	91	576,45	579,31	120	761,07	763,93
34	213,60	216,44	63	398,20	401,06	92	582,85	585,67			
35	219,95	222,81	64	404,55	407,43	93	589,20	592,04			
36	226,35	229,18	65	410,95	413,80	94	595,55	598,41			
37	232,70	235,54	66	417,30	420,17	95	601,90	604,77			
38	239,05	241,91	67	423,65	426,52	96	608,30	611,14			
39	245,40	248,28	68	430,05	432,89	97	614,65	617,51			
40	251,75	254,65	69	436,40	439,26	98	621,00	623,88			
41	258,15	261,02	70	442,80	445,63	99	627,35	630,25			
42	264,50	267,37	71	449,15	451,99	100	633,75	636,60			
43	270,85	273,74	72	455,50	458,36	101	640,10	642,97			

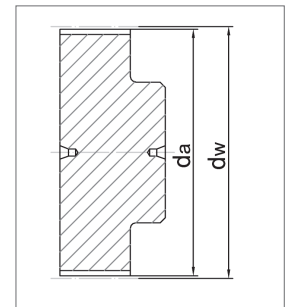

AT5

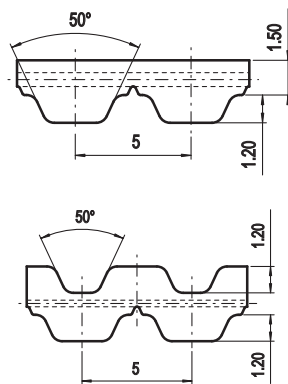

Belt characteristics

- Polyurethane timing belt with steel tension cords.
- Metric pitch 5 mm
- Tooth profile and dimension are optimised to guarantee uniform load distribution and minimum deformation under load.
- High resistance and low stretch steel cords to guarantee high stability and low elongation
- Reduced polygonal effect with reduced drive vibration.
- Particularly suitable for linear drives and light power transmission applications with high axial and angular positioning accuracy.
- Double sided tooth construction available
- Negative length tolerance available on request

- Width tolerance: $\pm 0,5$ [mm]
- Length tolerance: $\pm 0,5$ [mm/m]
- Thickness tolerance: $\pm 0,2$ [mm]

Technical data

Belt width b [mm]	Allowable tensile load Type M F_{Tzul} [N]	Allowable tensile load Type V F_{Tzul} [N]	Breaking load Type M F_{Br} [N]	Specific spring rate C_{spez} [N]	Weight [kg/m]
10	640	320	2160	160000	0,03
16	1120	560	3780	280000	0,05
25	1840	920	6210	460000	0,09
32	2400	1200	8100	600000	0,11
50	3840	1920	12960	960000	0,17
75	5840	2920	19710	1460000	0,26
100	7840	3920	26460	1960000	0,34

Load / Elongation [%]

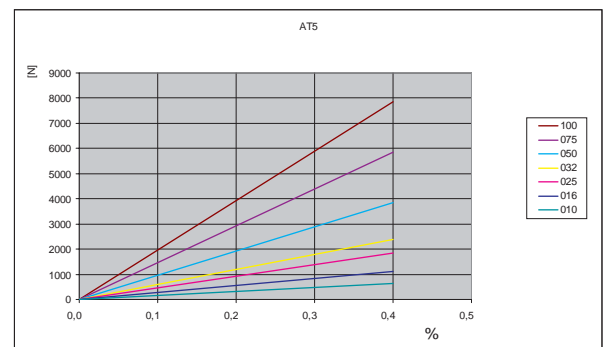

Other widths are available on request.

Tooth shear strength

rpm	F_{Uspez} [N/cm]	rpm	F_{Uspez} [N/cm]	rpm	F_{Uspez} [N/cm]	rpm	F_{Uspez} [N/cm]
0	36,40	800	27,69	1900	22,73	4500	17,18
20	35,88	900	27,06	2000	22,42	5000	16,47
40	35,40	1000	26,49	2200	21,82	5500	15,83
60	34,97	1100	25,96	2400	21,28	6000	15,24
80	34,59	1200	25,47	2600	20,77	6500	14,69
100	34,24	1300	25,01	2800	20,29	7000	14,18
200	32,92	1400	24,57	3000	19,85	7500	13,71
300	31,92	1440	24,41	3200	19,43	8000	13,26
400	30,89	1500	24,16	3400	19,03	8500	12,85
500	29,95	1600	23,78	3600	18,66	9000	12,45
600	29,12	1700	23,41	3800	18,30	9500	12,07
700	28,37	1800	23,07	4000	17,96	10000	11,72

Tooth shear strength / rpm

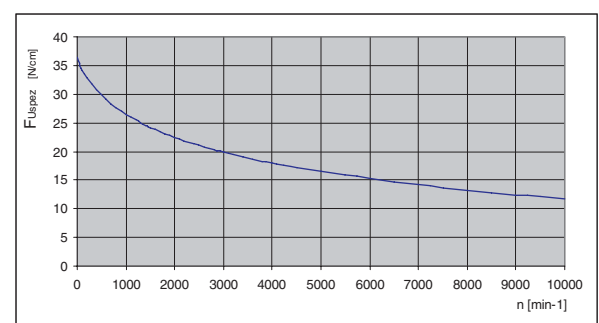

The specific load F_{Uspez} is the maximum load which one single belt tooth 1 cm wide can withstand in all operating conditions. This force is related to the drive rpm. The total load F_U transmissible by the belt in the drive is calculated by:

$$F_U [N] = F_{Uspez} \cdot z_e \cdot b$$

- F_U [N] = peripheral force
- F_{Uspez} [N/cm] = specific load
- z_e = number of teeth in mesh in the small pulley
- z_{emax} = max. no of teeth in mesh to be considered for the calculation of the drive
- $z_{emax} = 12$ for ELATECH® M
- $z_{emax} = 6$ for ELATECH® V
- b [cm] = belt width in cm

Specialties

PROFILE	Belt width b [mm]	ARAMID CORD		STAINLESS STEEL	
		F _{Tzul} [N] M type	F _{Br} [N]	F _{Tzul} [N] M type	F _{Br} [N]
AT5	010	880	3600	600	2400
	016	1540	6300	1050	4200
	025	2530	10350	1730	6900
	032	3300	13500	2250	9000
	050	5280	21600	3600	14400
	075	8030	32850		
	100	10780	44100		

Flexibility

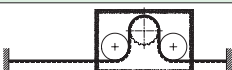
Minimum pulley number of teeth and minimum idler diameter				
AT5		TYPE OF CORD		
		STANDARD	ARAMID	STAINLESS
Drive without reverse bending 	Timing pulley z _{min}	15	15	15
	Idler running on belt teeth d _{min}	30 mm	30 mm	65 mm
Drive with reverse bending 	Timing pulley z _{min}	25	25	25
	Idler running on belt back d _{min}	60 mm	60 mm	65 mm

Timing pulleys

z	d _a	d _w	z	d _a	d _w	z	d _a	d _w	z	d _a	d _w
15	22,65	23,88	44	68,80	70,05	73	114,95	116,22	102	161,15	162,38
16	24,20	25,47	45	70,40	71,64	74	116,55	117,81	103	162,70	163,97
17	25,80	27,06	46	72,00	73,23	75	118,15	119,40	104	164,30	165,57
18	27,40	28,65	47	73,55	74,82	76	119,75	120,99	105	165,90	167,16
19	29,00	30,25	48	75,15	76,42	77	121,35	122,58	106	167,50	168,75
20	30,60	31,83	49	76,75	78,01	78	122,90	124,18	107	169,10	170,34
21	32,20	33,43	50	78,35	79,60	79	124,50	125,77	108	170,70	171,94
22	33,80	35,02	51	79,95	81,19	80	126,10	127,36	109	172,25	173,53
23	35,40	36,62	52	81,55	82,78	81	127,70	128,95	110	173,85	175,12
24	37,00	38,21	53	83,10	84,38	82	129,30	130,54	111	175,45	176,71
25	38,60	39,80	54	84,70	85,97	83	130,90	132,14	112	177,05	178,30
26	40,20	41,39	55	86,30	87,54	84	132,45	133,73	113	178,65	179,84
27	41,80	42,98	56	87,90	89,15	85	134,05	135,32	114	180,25	181,49
28	43,35	44,58	57	89,50	90,74	86	135,65	136,91	115	181,85	183,08
29	44,95	46,17	58	91,10	92,34	87	137,25	138,50	116	183,45	184,67
30	46,55	47,76	59	92,65	93,93	88	138,85	140,10	117	185,00	186,26
31	48,15	49,35	60	94,25	95,52	89	140,45	141,69	118	186,60	187,86
32	49,70	50,94	61	95,85	97,11	90	142,05	143,28	119	188,20	189,45
33	51,30	52,54	62	97,45	98,70	91	143,60	144,87	120	189,80	191,04
34	52,85	54,13	63	99,05	100,30	92	145,20	146,46			
35	54,45	55,72	64	100,65	101,89	93	146,80	148,06			
36	56,05	57,31	65	102,25	103,48	94	148,40	149,65			
37	57,65	58,90	66	103,80	105,07	95	150,00	151,24			
38	59,25	60,50	67	105,40	106,66	96	151,60	152,83			
39	60,85	62,09	68	107,00	108,26	97	153,15	154,42			
40	62,45	63,66	69	108,60	109,85	98	154,75	156,02			
41	64,00	65,27	70	110,20	111,44	99	156,35	157,61			
42	65,60	66,86	71	111,80	113,03	100	157,95	159,20			
43	67,30	68,46	72	113,35	114,62	101	159,55	160,79			

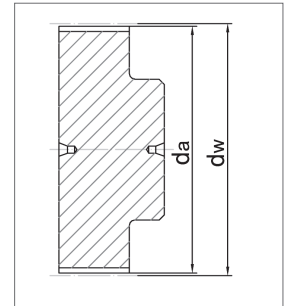

AT10

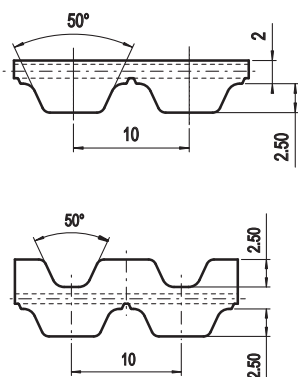

Belt characteristics

- Polyurethane timing belt with steel tension cords.
 - Metric pitch 10 mm
 - Tooth profile and dimension are optimised to guarantee uniform load distribution and minimum deformation under load.
 - High resistance and low stretch steel cords to guarantee high stability and low elongation
 - Reduced polygonal effect with reduced drive vibration.
 - Particularly suitable for linear drives and medium power transmission applications with high axial and angular positioning accuracy.
 - Double sided tooth construction available
 - Negative length tolerance available on request
- Width tolerance: $\pm 0,5$ [mm]
 - Length tolerance: $\pm 0,5$ [mm/m]
 - Thickness tolerance: $\pm 0,3$ [mm]

Technical data

Belt width b [mm]	Allowable tensile load Type M F_{Tzul} [N]	Allowable tensile load Type V F_{Tzul} [N]	Breaking load Type M F_{Br} [N]	Specific spring rate C_{spez} [N]	Weight [kg/m]
16	2450	1225	9500	612500	0,09
25	4170	2085	16150	1042500	0,15
32	5390	2695	20900	1347500	0,19
50	8580	4290	33250	2145000	0,30
75	12990	6495	50350	3247500	0,44
100	17400	8700	67450	4350000	0,59
150	26220	13110	101650	6555000	0,74

Load / Elongation [%]

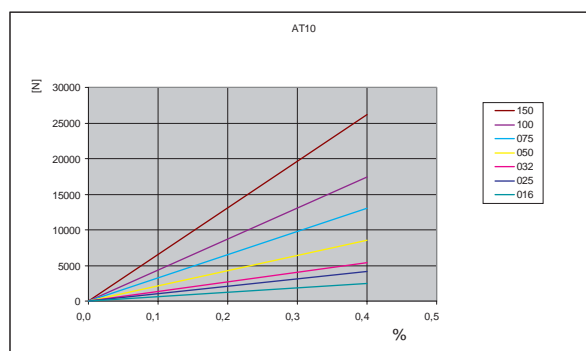

Other widths are available on request.

Tooth shear strength

rpm	F_{Uspez} [N/cm]	rpm	F_{Uspez} [N/cm]	rpm	F_{Uspez} [N/cm]	rpm	F_{Uspez} [N/cm]
0	75,70	800	53,70	1900	42,02	4500	29,13
20	74,59	900	52,21	2000	41,28	5000	27,50
40	73,55	1000	50,85	2200	39,89	5500	26,01
60	72,57	1100	49,59	2400	38,62	6000	24,65
80	71,65	1200	48,43	2600	37,44	6500	23,40
100	70,78	1300	47,34	2800	36,33	7000	22,23
200	67,13	1400	46,32	3000	35,30	7500	21,14
300	64,18	1440	45,93	3200	34,33	8000	20,12
400	61,53	1500	45,36	3400	33,41	8500	19,15
500	59,21	1600	44,46	3600	32,55	9000	18,24
600	57,16	1700	43,60	3800	31,72	9500	17,38
700	55,34	1800	42,79	4000	30,94	10000	16,56

Tooth shear strength / rpm

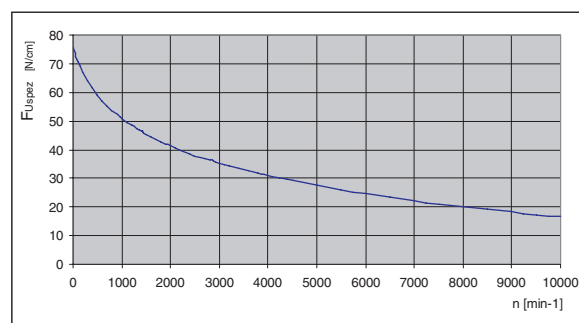

The specific load F_{Uspez} is the maximum load which one single belt tooth 1 cm wide can withstand in all operating conditions. This force is related to the drive rpm. The total load F_U transmissible by the belt in the drive is calculated by:

$$F_U [N] = F_{Uspez} \cdot z_e \cdot b$$

F_U [N] = peripheral force
 F_{Uspez} [N/cm] = specific load
 z_e = number of teeth in mesh in the small pulley
 z_{emax} = max. no of teeth in mesh to be considered for the calculation of the drive
 $z_{emax} = 12$ for ELATECH® M
 $z_{emax} = 6$ for ELATECH® V
 b [cm] = belt width in cm

Specialties

PROFILE	Belt width b [mm]	ARAMID CORD		STAINLESS STEEL		HFE High flexibility	
		F _{Tzul} [N] M type	F _{Br} [N]	F _{Tzul} [N] M type	F _{Br} [N]	F _{Tzul} [N] M type	F _{Br} [N]
AT10	016	1900	7900	1800	7500	2000	8500
	025	3230	13430	3060	12750	3400	14450
	032	4180	17380	3960	16500	4400	18700
	050	6650	27650	6300	26250	7000	29750
	075	10070	41870			10600	45050
	100	13490	56090			14200	60350
	150	20330	84530				

Flexibility

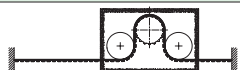
Minimum pulley number of teeth and minimum idler diameter					
AT10		TYPE OF CORD			
		STANDARD	ARAMID	STAINLESS	HFE
Drive without reverse bending 	Timing pulley z _{min}	15	15	18	15
	Idler running on belt teeth d _{min}	50 mm	50 mm	100 mm	50 mm
Drive with reverse bending 	Timing pulley z _{min}	25	20	25	15
	Idler running on belt back d _{min}	120 mm	120 mm	100 mm	80 mm

Timing pulleys

z	da	dw	z	da	dw	z	da	dw	z	da	dw
18	55,45	57,29	47	147,75	149,60	76	240,05	241,94	105	332,35	334,21
19	58,60	60,48	48	150,95	152,78	77	243,25	245,09	106	335,55	337,40
20	61,80	63,66	49	154,10	155,97	78	246,40	248,24	107	338,75	340,58
21	65,00	66,84	50	157,30	159,15	79	249,60	251,46	108	341,90	343,76
22	68,15	70,03	51	160,50	162,33	80	252,80	254,64	109	345,10	346,95
23	71,35	73,20	52	163,65	165,52	81	255,95	257,82	110	348,30	350,13
24	74,55	76,39	53	166,85	168,70	82	259,15	261,00	111	351,45	353,31
25	77,70	79,58	54	170,05	171,88	83	262,30	264,19	112	354,65	356,50
26	80,90	82,76	55	173,20	175,06	84	265,50	267,37	113	357,80	359,68
27	84,10	85,95	56	176,40	178,25	85	268,70	270,52	114	361,00	362,86
28	87,25	89,12	57	179,60	181,43	86	271,90	273,74	115	364,19	366,04
29	90,45	92,21	58	182,75	184,61	87	275,05	276,92	116	367,39	369,23
30	93,65	95,49	59	185,95	187,80	88	278,25	280,10	117	370,56	372,41
31	96,80	98,67	60	189,10	190,98	89	281,45	283,28	118	373,74	375,59
32	100,00	101,86	61	192,30	194,16	90	284,60	286,47	119	376,93	378,78
33	103,20	105,04	62	195,50	197,35	91	287,80	289,65	120	380,11	381,96
34	106,40	108,19	63	198,65	200,53	92	291,00	292,84			
35	109,55	111,41	64	201,85	203,71	93	294,20	296,02			
36	112,75	114,59	65	205,05	206,90	94	297,35	299,20			
37	115,90	117,77	66	208,20	210,08	95	300,55	302,39			
38	119,10	120,95	67	211,40	213,26	96	303,70	305,57			
39	122,30	124,14	68	214,60	216,44	97	306,90	308,75			
40	125,45	127,32	69	217,75	219,63	98	310,10	311,93			
41	128,65	130,50	70	220,95	222,81	99	313,25	315,12			
42	131,85	133,69	71	224,15	225,99	100	316,45	318,30			
43	135,00	136,87	72	227,30	229,18	101	319,65	321,48			
44	138,20	140,05	73	230,50	232,33	102	322,80	324,66			
45	141,40	143,24	74	233,70	235,54	103	326,00	327,85			
46	144,55	146,42	75	236,90	238,72	104	329,20	331,03			

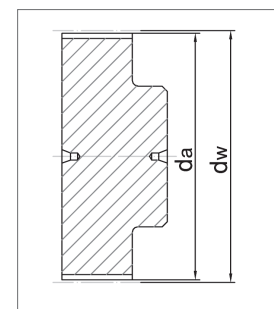

AT20

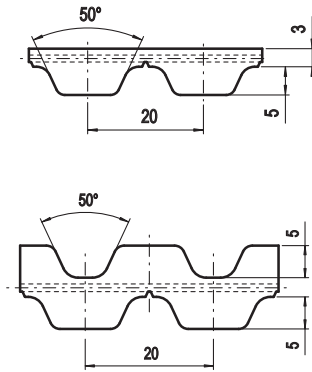

Belt characteristics

- Polyurethane timing belt with steel tension cords.
 - Metric pitch 20 mm
 - Tooth profile and dimension are optimised to guarantee uniform load distribution and minimum deformation under load.
 - High resistance and low stretch steel cords to guarantee high stability and low elongation
 - Reduced polygonal effect with reduced drive vibration.
 - Particularly suitable for linear drives and heavy power transmission applications with high axial and angular positioning accuracy.
 - Double sided tooth construction available
- Width tolerance: $\pm 1,0$ [mm]
 - Length tolerance: $\pm 0,5$ [mm/m]
 - Thickness tolerance: $\pm 0,4$ [mm]

Technical data

Belt width b [mm]	Allowable tensile load Type M F_{Tzul} [N]	Allowable tensile load Type V F_{Tzul} [N]	Breaking load Type M F_{Br} [N]	Specific spring rate C_{spez} [N]	Weight [kg/m]
25	5280	2640	19250	1320000	0,24
32	7200	3600	26250	1800000	0,31
50	11520	5760	42000	2880000	0,48
75	17280	8640	63000	4320000	0,73
100	23520	11760	85750	5880000	0,97
150	35520	17760	129500	8880000	1,45

Load / Elongation [%]

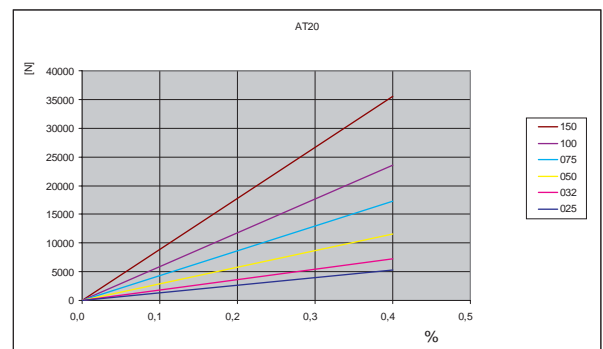

Other widths are available on request.

Tooth shear strength

rpm	F_{Uspez} [N/cm]	rpm	F_{Uspez} [N/cm]	rpm	F_{Uspez} [N/cm]	rpm	F_{Uspez} [N/cm]
0	151,40	800	97,44	1900	69,96	4500	39,72
20	148,56	900	93,93	2000	68,22	5000	35,90
40	145,89	1000	90,73	2200	64,97	5500	32,42
60	143,38	1100	87,77	2400	61,98	6000	29,23
80	141,01	1200	85,02	2600	59,20	6500	26,29
100	138,78	1300	82,47	2800	56,62		
200	129,43	1400	80,07	3000	54,20		
300	122,28	1440	79,16	3200	51,92		
400	115,96	1500	77,82	3400	49,77		
500	110,45	1600	75,70	3600	47,74		
600	105,61	1700	73,69	3800	45,80		
700	101,31	1800	71,77	4000	43,96		

Tooth shear strength / rpm

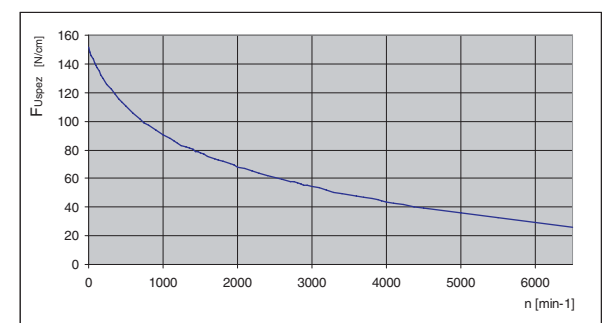

The specific load F_{Uspez} is the maximum load which one single belt tooth 1 cm wide can withstand in all operating conditions. This force is related to the drive rpm. The total load F_U transmissible by the belt in the drive is calculated by:

$$F_U [N] = F_{Uspez} \cdot z_e \cdot b$$

- F_U [N] = peripheral force
- F_{Uspez} [N/cm] = specific load
- z_e = number of teeth in mesh in the small pulley
- z_{emax} = max. no of teeth in mesh to be considered for the calculation of the drive
- $z_{emax} = 12$ for ELATECH® M
- $z_{emax} = 6$ for ELATECH® V
- b [cm] = belt width in cm

Flexibility

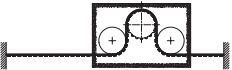
Minimum pulley number of teeth and minimum idler diameter		
AT20		TYPE OF CORD
		STANDARD
Drive without reverse bending 	Timing pulley z_{min}	18
	Idler running on belt teeth d_{min}	120 mm
Drive with reverse bending 	Timing pulley z_{min}	25
	Idler running on belt back d_{min}	180 mm

Timing pulleys

z	da	dw	z	da	dw	z	da	dw	z	da	dw
18	111,75	114,59	47	296,35	299,21	76	480,95	483,82	105	665,60	668,43
19	118,10	120,95	48	302,70	305,58	77	487,35	490,19	106	671,95	674,80
20	124,50	127,32	49	309,10	311,93	78	493,70	496,56	107	678,30	681,17
21	130,75	133,69	50	315,45	318,30	79	500,05	502,91	108	684,70	687,54
22	137,20	140,05	51	321,80	324,67	80	506,45	509,28	109	691,05	693,89
23	143,55	146,42	52	328,20	331,03	81	512,80	515,65	110	697,40	700,26
24	149,95	152,78	53	334,55	337,40	82	519,15	522,02	111	703,80	706,63
25	156,30	159,15	54	340,90	343,76	83	525,55	528,39	112	710,15	712,99
26	162,65	165,52	55	347,30	350,13	84	531,90	534,74	113	716,50	719,36
27	169,05	171,88	56	353,65	356,50	85	538,25	541,11	114	722,90	725,72
28	175,40	178,25	57	360,00	362,86	86	544,60	547,48	115	729,24	732,09
29	181,75	184,62	58	366,40	369,23	87	551,00	553,85	116	735,61	738,46
30	188,15	190,99	59	372,75	375,59	88	557,35	560,22	117	741,96	744,83
31	194,50	197,35	60	379,10	381,96	89	563,70	566,57	118	748,34	751,19
32	200,85	203,72	61	385,45	388,33	90	570,10	572,94	119	754,70	757,56
33	207,20	210,09	62	391,85	394,69	91	576,45	579,31	120	761,07	763,93
34	213,60	216,44	63	398,20	401,06	92	582,85	585,67			
35	219,95	222,81	64	404,55	407,43	93	589,20	592,04			
36	226,35	229,18	65	410,95	413,79	94	595,55	598,40			
37	232,70	235,54	66	417,30	420,16	95	601,90	604,77			
38	239,05	241,91	67	423,65	426,52	96	608,30	611,14			
39	245,45	248,27	68	430,05	432,89	97	614,65	617,50			
40	251,80	254,64	69	436,40	439,26	98	621,00	623,87			
41	258,15	261,01	70	442,80	445,63	99	627,35	630,24			
42	264,50	267,37	71	449,15	451,99	100	633,75	636,60			
43	270,90	273,74	72	455,50	458,36	101	640,10	642,97			
44	277,25	280,10	73	461,85	464,73	102	646,50	649,34			
45	283,60	286,47	74	468,25	471,08	103	652,85	655,71			
46	290,00	292,84	75	474,60	477,45	104	659,20	662,06			

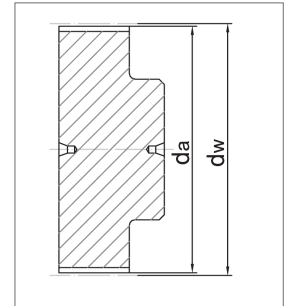

ATL5

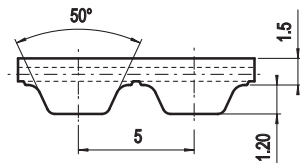

Belt characteristics

- High performance polyurethane timing belt with HPL steel tension cords.
 - Metric pitch 5,0 mm
 - Specially designed for linear drives
 - Tension cords with increased allowable tensile load compared to standard for lower elongation.
 - Produced with special pretension and pitch tolerance to guarantee high positioning precision in linear drives
 - Negative length tolerance available on request
- Width tolerance: $\pm 0,5$ [mm]
 - Thickness tolerance: $\pm 0,2$ [mm]

Technical data

Belt width b [mm]	Allowable tensile load Type M F_{Tzul} [N]	Breaking load Type M F_{Br} [N]	Specific spring rate C_{spez} [N]	Weight [kg/m]
10	920	3360	230000	0,04
16	1610	5880	402500	0,06
25	2650	9660	662500	0,10
32	3450	12600	862500	0,12
50	5520	20160	1380000	0,19
75	8400	30660	2100000	0,29
100	11270	41160	2817500	0,38

Load / Elongation [%]

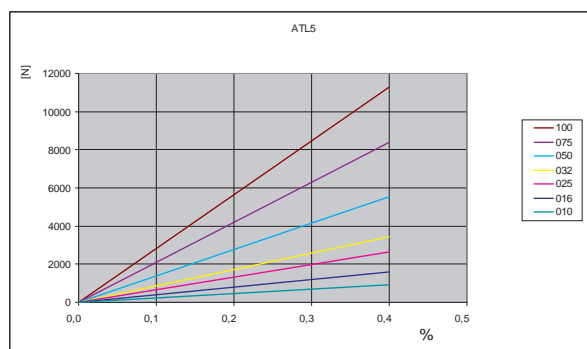

Other widths are available on request.

Tooth shear strength

rpm	F_{Uspez} [N/cm]	rpm	F_{Uspez} [N/cm]	rpm	F_{Uspez} [N/cm]	rpm	F_{Uspez} [N/cm]
0	36,40	800	27,69	1900	22,73	4500	17,18
20	35,88	900	27,06	2000	22,42	5000	16,47
40	35,40	1000	26,49	2200	21,82	5500	15,83
60	34,97	1100	25,96	2400	21,28	6000	15,24
80	34,59	1200	25,47	2600	20,77	6500	14,69
100	34,24	1300	25,01	2800	20,29	7000	14,18
200	32,92	1400	24,57	3000	19,85	7500	13,71
300	31,92	1440	24,41	3200	19,43	8000	13,26
400	30,89	1500	24,16	3400	19,03	8500	12,85
500	29,95	1600	23,78	3600	18,66	9000	12,45
600	29,12	1700	23,41	3800	18,30	9500	12,07
700	28,37	1800	23,07	4000	17,96	10000	11,72

Tooth shear strength / rpm

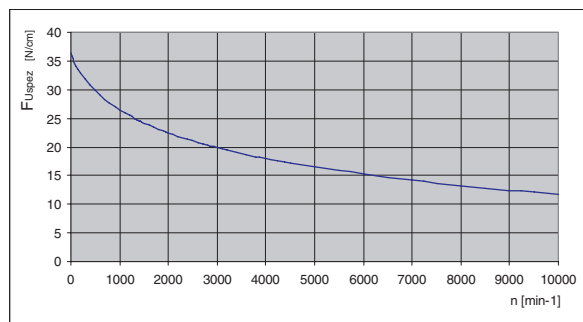



The specific load F_{Uspez} is the maximum load which one single belt tooth 1 cm wide can withstand in all operating conditions. This force is related to the drive rpm. The total load F_U transmissible by the belt in the drive is calculated by:

$$F_U [N] = F_{Uspez} \cdot z_e \cdot b$$

- $F_U [N]$ = peripheral force
- $F_{Uspez} [N/cm]$ = specific load
- z_e = number of teeth in mesh in the small pulley
- z_{emax} = max. no of teeth in mesh to be considered for the calculation of the drive
- $z_{emax} = 12$ for ELATECH® M
- $z_{emax} = 6$ for ELATECH® V
- $b [cm]$ = belt width in cm

Flexibility

Minimum pulley number of teeth and minimum idler diameter		
ATL5		TYPE OF CORD
		STANDARD
 Drive without reverse bending	Timing pulley z_{min}	25
	Idler running on belt teeth d_{min}	40 mm
 Drive with reverse bending	Timing pulley z_{min}	25
	Idler running on belt back d_{min}	60 mm

Timing pulleys

z	d_a	d_w	z	d_a	d_w	z	d_a	d_w	z	d_a	d_w
15	22,65	23,88	44	68,80	70,05	73	114,95	116,22	102	161,15	162,38
16	24,20	25,47	45	70,40	71,64	74	116,55	117,81	103	162,70	163,97
17	25,80	27,06	46	72,00	73,23	75	118,15	119,40	104	164,30	165,57
18	27,40	28,65	47	73,55	74,82	76	119,75	120,99	105	165,90	167,16
19	29,00	30,25	48	75,15	76,42	77	121,35	122,58	106	167,50	168,75
20	30,60	31,83	49	76,75	78,01	78	122,90	124,18	107	169,10	170,34
21	32,20	33,43	50	78,35	79,60	79	124,50	125,77	108	170,70	171,94
22	33,80	35,02	51	79,95	81,19	80	126,10	127,36	109	172,25	173,53
23	35,40	36,62	52	81,55	82,78	81	127,70	128,95	110	173,85	175,12
24	37,00	38,21	53	83,10	84,38	82	129,30	130,54	111	175,45	176,71
25	38,60	39,80	54	84,70	85,97	83	130,90	132,14	112	177,05	178,30
26	40,20	41,39	55	86,30	87,54	84	132,45	133,73	113	178,65	179,84
27	41,80	42,98	56	87,90	89,15	85	134,05	135,32	114	180,25	181,49
28	43,35	44,58	57	89,50	90,74	86	135,65	136,91	115	181,85	183,08
29	44,95	46,17	58	91,10	92,34	87	137,25	138,50	116	183,45	184,67
30	46,55	47,76	59	92,65	93,93	88	138,85	140,10	117	185,00	186,26
31	48,15	49,35	60	94,25	95,52	89	140,45	141,69	118	186,60	187,86
32	49,70	50,94	61	95,85	97,11	90	142,05	143,28	119	188,20	189,45
33	51,30	52,54	62	97,45	98,70	91	143,60	144,87	120	189,80	191,04
34	52,85	54,13	63	99,05	100,30	92	145,20	146,46			
35	54,45	55,72	64	100,65	101,89	93	146,80	148,06			
36	56,05	57,31	65	102,25	103,48	94	148,40	149,65			
37	57,65	58,90	66	103,80	105,07	95	150,00	151,24			
38	59,25	60,50	67	105,40	106,66	96	151,60	152,83			
39	60,85	62,09	68	107,00	108,26	97	153,15	154,42			
40	62,45	63,66	69	108,60	109,85	98	154,75	156,02			
41	64,00	65,27	70	110,20	111,44	99	156,35	157,61			
42	65,60	66,86	71	111,80	113,03	100	157,95	159,20			
43	67,30	68,46	72	113,35	114,62	101	159,55	160,79			

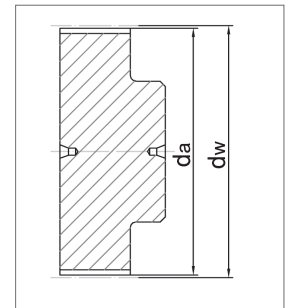

ATL10

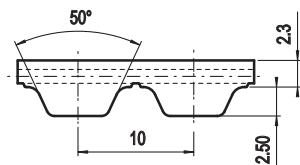

Belt characteristics

- High performance polyurethane timing belt with HPL steel tension cords.
 - Metric pitch 10 mm
 - Specially designed for linear drives
 - Tension cords with increased allowable tensile load compared to standard for lower elongation.
 - Produced with special pretension and pitch tolerance to guarantee high positioning precision in linear drives
 - Negative length tolerance available on request
- Width tolerance: $\pm 0,5$ [mm]
 - Thickness tolerance: $\pm 0,2$ [mm]

Technical data

Belt width b [mm]	Allowable tensile load Type M F_{Tzul} [N]	Breaking load Type M F_{Br} [N]	Specific spring rate C_{spez} [N]	Weight [kg/m]
16	3840	14000	960000	0,11
25	6720	24500	1680000	0,17
32	8640	31500	2160000	0,22
50	14400	52500	3600000	0,35
75	21600	78750	5400000	0,52
100	29280	106750	7320000	0,69
150	44160	161000	11040000	0,85

Load / Elongation [%]

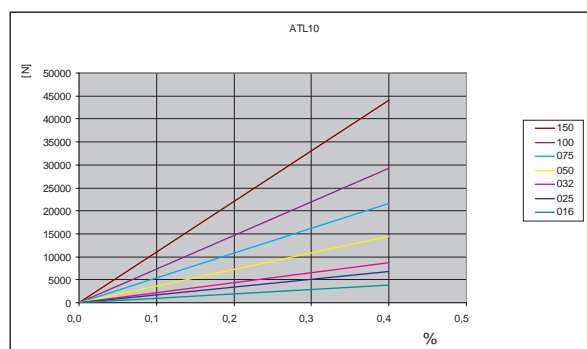

Other widths are available on request.

Tooth shear strength

rpm	F_{Uspez} [N/cm]	rpm	F_{Uspez} [N/cm]	rpm	F_{Uspez} [N/cm]	rpm	F_{Uspez} [N/cm]
0	75,70	800	53,70	1900	42,02	4500	29,13
20	74,59	900	52,21	2000	41,28	5000	27,50
40	73,55	1000	50,85	2200	39,89	5500	26,01
60	72,57	1100	49,59	2400	38,62	6000	24,65
80	71,65	1200	48,43	2600	37,44	6500	23,40
100	70,78	1300	47,34	2800	36,33	7000	22,23
200	67,13	1400	46,32	3000	35,30	7500	21,14
300	64,18	1440	45,93	3200	34,33	8000	20,12
400	61,53	1500	45,36	3400	33,41	8500	19,15
500	59,21	1600	44,46	3600	32,55	9000	18,24
600	57,16	1700	43,60	3800	31,72	9500	17,38
700	55,34	1800	42,79	4000	30,94	10000	16,56

Tooth shear strength / rpm

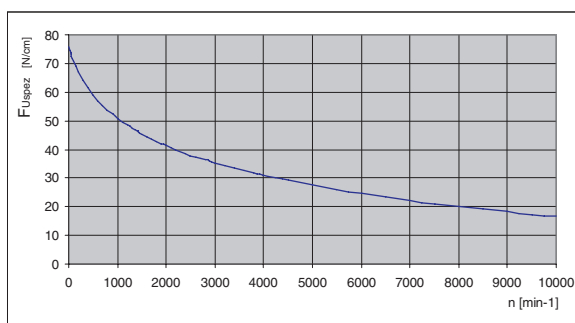

The specific load F_{Uspez} is the maximum load which one single belt tooth 1 cm wide can withstand in all operating conditions. This force is related to the drive rpm. The total load F_U transmissible by the belt in the drive is calculated by:

$$F_U [N] = F_{Uspez} \cdot z_e \cdot b$$

- $F_U [N]$ = peripheral force
- $F_{Uspez} [N/cm]$ = specific load
- z_e = number of teeth in mesh in the small pulley
- z_{emax} = max. no of teeth in mesh to be considered for the calculation of the drive
- $z_{emax} = 12$ for ELATECH® M
- $z_{emax} = 6$ for ELATECH® V
- $b [cm]$ = belt width in cm

Flexibility

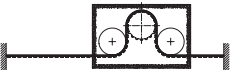
Minimum pulley number of teeth and minimum idler diameter		
ATL10		TYPE OF CORD
		STANDARD
Drive without reverse bending 	Timing pulley z_{min}	25
	Idler running on belt teeth d_{min}	80 mm
Drive with reverse bending 	Timing pulley z_{min}	25
	Idler running on belt back d_{min}	150 mm

Timing pulleys

z	d_a	d_w	z	d_a	d_w	z	d_a	d_w	z	d_a	d_w
18	55,45	57,29	47	147,75	149,60	76	240,05	241,94	105	332,35	334,21
19	58,60	60,48	48	150,95	152,78	77	243,25	245,09	106	335,55	337,40
20	61,80	63,66	49	154,10	155,97	78	246,40	248,24	107	338,75	340,58
21	65,00	66,84	50	157,30	159,15	79	249,60	251,46	108	341,90	343,76
22	68,15	70,03	51	160,50	162,33	80	252,80	254,64	109	345,10	346,95
23	71,35	73,20	52	163,65	165,52	81	255,95	257,82	110	348,30	350,13
24	74,55	76,39	53	166,85	168,70	82	259,15	261,00	111	351,45	353,31
25	77,70	79,58	54	170,05	171,88	83	262,30	264,19	112	354,65	356,50
26	80,90	82,76	55	173,20	175,06	84	265,50	267,37	113	357,80	359,68
27	84,10	85,95	56	176,40	178,25	85	268,70	270,52	114	361,00	362,86
28	87,25	89,12	57	179,60	181,43	86	271,90	273,74	115	364,19	366,04
29	90,45	92,21	58	182,75	184,61	87	275,05	276,92	116	367,39	369,23
30	93,65	95,49	59	185,95	187,80	88	278,25	280,10	117	370,56	372,41
31	96,80	98,67	60	189,10	190,98	89	281,45	283,28	118	373,74	375,59
32	100,00	101,86	61	192,30	194,16	90	284,60	286,47	119	376,93	378,78
33	103,20	105,04	62	195,50	197,35	91	287,80	289,65	120	380,11	381,96
34	106,40	108,19	63	198,65	200,53	92	291,00	292,84			
35	109,55	111,41	64	201,85	203,71	93	294,20	296,02			
36	112,75	114,59	65	205,05	206,90	94	297,35	299,20			
37	115,90	117,77	66	208,20	210,08	95	300,55	302,39			
38	119,10	120,95	67	211,40	213,26	96	303,70	305,57			
39	122,30	124,14	68	214,60	216,44	97	306,90	308,75			
40	125,45	127,32	69	217,75	219,63	98	310,10	311,93			
41	128,65	130,50	70	220,95	222,81	99	313,25	315,12			
42	131,85	133,69	71	224,15	225,99	100	316,45	318,30			
43	135,00	136,87	72	227,30	229,18	101	319,65	321,48			
44	138,20	140,05	73	230,50	232,33	102	322,80	324,66			
45	141,40	143,24	74	233,70	235,54	103	326,00	327,85			
46	144,55	146,42	75	236,90	238,72	104	329,20	331,03			

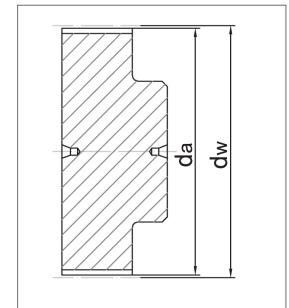

ATL20

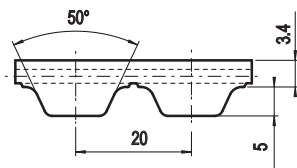

Belt characteristics

- High performance polyurethane timing belt with HPL steel tension cords.
 - Metric pitch 20 mm
 - Specially designed for linear drives
 - Tension cords with increased allowable tensile load compared to standard for lower elongation.
 - Produced with special pretension and pitch tolerance to guarantee high positioning precision in linear drives.
- Width tolerance: $\pm 1,0$ [mm]
 - Thickness tolerance: $\pm 0,4$ [mm]

Technical data

Belt width b [mm]	Allowable tensile load Type M F_{Tzul} [N]	Breaking load Type M F_{Br} [N]	Specific spring rate C_{spez} [N]	Weight [kg/m]
25	7650	28800	1912500	0,28
32	10200	38400	2550000	0,36
50	16150	60800	4037500	0,56
75	24650	92800	6162500	0,84
100	33150	124800	8287500	1,12
150	51000	192000	12750000	1,68

Load / Elongation [%]

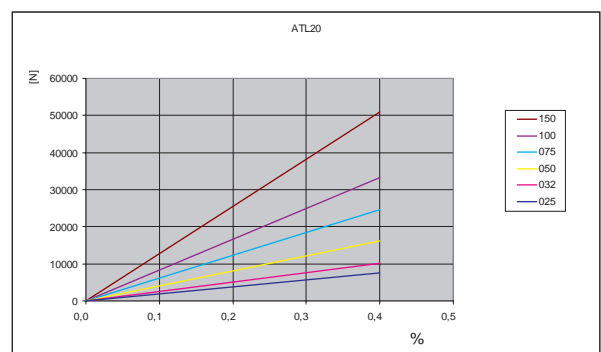

Other widths are available on request.

Tooth shear strength

rpm	F_{Uspez} [N/cm]	rpm	F_{Uspez} [N/cm]	rpm	F_{Uspez} [N/cm]	rpm	F_{Uspez} [N/cm]
0	151,40	800	97,44	1900	69,96	4500	39,72
20	148,56	900	93,93	2000	68,22	5000	35,90
40	145,89	1000	90,73	2200	64,97	5500	32,42
60	143,38	1100	87,77	2400	61,98	6000	29,23
80	141,01	1200	85,02	2600	59,20	6500	26,29
100	138,78	1300	82,47	2800	56,62	7000	
200	129,43	1400	80,07	3000	54,20	7500	
300	122,28	1440	79,16	3200	51,92	8000	
400	115,96	1500	77,82	3400	49,77	8500	
500	110,45	1600	75,70	3600	47,74	9000	
600	105,61	1700	73,69	3800	45,80	9500	
700	101,31	1800	71,77	4000	43,96	10000	

Tooth shear strength / rpm

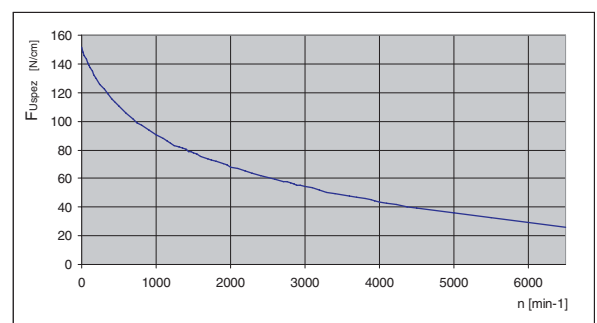

The specific load F_{Uspez} is the maximum load which one single belt tooth 1 cm wide can withstand in all operating conditions. This force is related to the drive rpm. The total load F_U transmissible by the belt in the drive is calculated by:

$$F_U [N] = F_{Uspez} \cdot z_e \cdot b$$

- $F_U [N]$ = peripheral force
- $F_{Uspez} [N/cm]$ = specific load
- z_e = number of teeth in mesh in the small pulley
- z_{emax} = max. no of teeth in mesh to be considered for the calculation of the drive
- $z_{emax} = 12$ for ELATECH® M
- $z_{emax} = 6$ for ELATECH® V
- $b [cm]$ = belt width in cm

Flexibility

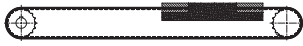
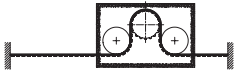
Minimum pulley number of teeth and minimum idler diameter		
ATL20		TYPE OF CORD
		STANDARD
Drive without reverse bending 	Timing pulley z_{min}	25
	Idler running on belt teeth d_{min}	160 mm
Drive with reverse bending 	Timing pulley z_{min}	25
	Idler running on belt back d_{min}	250 mm

Timing pulleys

z	d_a	d_w	z	d_a	d_w	z	d_a	d_w	z	d_a	d_w
18	111,75	114,59	47	296,35	299,21	76	480,95	483,82	105	665,60	668,43
19	118,10	120,95	48	302,70	305,58	77	487,35	490,19	106	671,95	674,80
20	124,50	127,32	49	309,10	311,93	78	493,70	496,56	107	678,30	681,17
21	130,75	133,69	50	315,45	318,30	79	500,05	502,91	108	684,70	687,54
22	137,20	140,05	51	321,80	324,67	80	506,45	509,28	109	691,05	693,89
23	143,55	146,42	52	328,20	331,03	81	512,80	515,65	110	697,40	700,26
24	149,95	152,78	53	334,55	337,40	82	519,15	522,02	111	703,80	706,63
25	156,30	159,15	54	340,90	343,76	83	525,55	528,39	112	710,15	712,99
26	162,65	165,52	55	347,30	350,13	84	531,90	534,74	113	716,50	719,36
27	169,05	171,88	56	353,65	356,50	85	538,25	541,11	114	722,90	725,72
28	175,40	178,25	57	360,00	362,86	86	544,60	547,48	115	729,24	732,09
29	181,75	184,62	58	366,40	369,23	87	551,00	553,85	116	735,61	738,46
30	188,15	190,99	59	372,75	375,59	88	557,35	560,22	117	741,96	744,83
31	194,50	197,35	60	379,10	381,96	89	563,70	566,57	118	748,34	751,19
32	200,85	203,72	61	385,45	388,33	90	570,10	572,94	119	754,70	757,56
33	207,20	210,09	62	391,85	394,69	91	576,45	579,31	120	761,07	763,93
34	213,60	216,44	63	398,20	401,06	92	582,85	585,67			
35	219,95	222,81	64	404,55	407,43	93	589,20	592,04			
36	226,35	229,18	65	410,95	413,79	94	595,55	598,40			
37	232,70	235,54	66	417,30	420,16	95	601,90	604,77			
38	239,05	241,91	67	423,65	426,52	96	608,30	611,14			
39	245,45	248,27	68	430,05	432,89	97	614,65	617,50			
40	251,80	254,64	69	436,40	439,26	98	621,00	623,87			
41	258,15	261,01	70	442,80	445,63	99	627,35	630,24			
42	264,50	267,37	71	449,15	451,99	100	633,75	636,60			
43	270,90	273,74	72	455,50	458,36	101	640,10	642,97			
44	277,25	280,10	73	461,85	464,73	102	646,50	649,34			
45	283,60	286,47	74	468,25	471,08	103	652,85	655,71			
46	290,00	292,84	75	474,60	477,45	104	659,20	662,06			

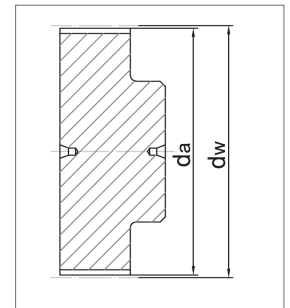

XL

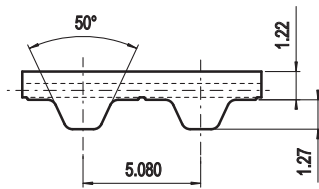

Belt characteristics

- Polyurethane timing belt with trapezoidal tooth profile according to DIN/ISO 5296 with steel tension cords
- Imperial pitch 1/5" = 5,08 mm
- Allow to use small diameter pulley
- Mainly used in applications where inch pitch is an advantage (USA / UK)

- Width tolerance: $\pm 0,5$ [mm]
- Length tolerance: $\pm 0,5$ [mm/m]
- Thickness tolerance: $\pm 0,2$ [mm]

Technical data

Belt width b	Allowable tensile load Type M F_{Tzul} [N]	Allowable tensile load Type V F_{Tzul} [N]	Breaking load Type M F_{Br} [N]	Specific spring rate C_{spez} [N]	Weight [kg/m]
Code /mm					
025 / 6,35	190	95	750	47500	0,015
031 / 7,94	220	110	875	55000	0,019
037 / 9,53	290	145	1125	72500	0,023
050 / 12,7	420	210	1625	105000	0,031
075 / 19,1	670	335	2625	167500	0,046
100 / 25,4	900	450	3500	225000	0,061
150 / 38,1	1410	705	5500	352500	0,092
200 / 50,8	1890	945	7375	472500	0,122
400/101,6	3840	1920	15000	960000	0,244

Other widths are available on request.

Load / Elongation [%]

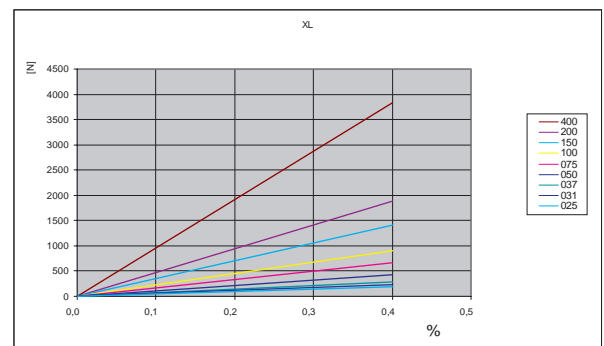

Tooth shear strength

rpm	F_{Uspez} [N/cm]	rpm	F_{Uspez} [N/cm]	rpm	F_{Uspez} [N/cm]	rpm	F_{Uspez} [N/cm]
0	25,10	800	17,32	1900	14,46	4500	11,45
20	24,46	900	16,94	2000	14,28	5000	11,08
40	23,90	1000	16,60	2200	13,96	5500	10,74
60	23,42	1100	16,29	2400	13,66	6000	10,43
80	23,00	1200	16,01	2600	13,38	6500	10,14
100	22,63	1300	15,74	2800	13,12	7000	9,87
200	21,24	1400	15,49	3000	12,88	7500	9,63
300	20,22	1440	15,40	3200	12,65	8000	9,39
400	19,42	1500	15,26	3400	12,44	8500	9,17
500	18,77	1600	15,04	3600	12,24	9000	8,97
600	18,22	1700	14,84	3800	12,05	9500	8,77
700	17,74	1800	14,64	4000	11,87	10000	8,59

Tooth shear strength / rpm

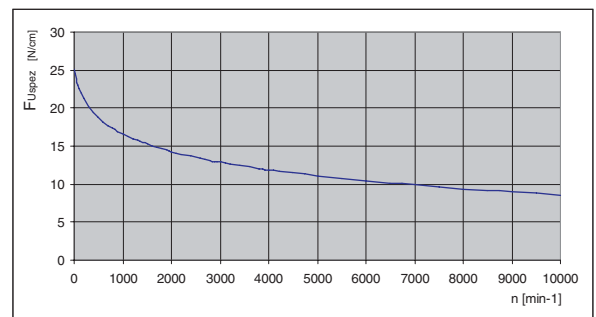

The specific load F_{Uspez} is the maximum load which one single belt tooth 1 cm wide can withstand in all operating conditions. This force is related to the drive rpm.

The total load F_U transmissible by the belt in the drive is calculated by:

$$F_U [N] = F_{Uspez} \cdot z_e \cdot b$$

F_U [N]

F_{Uspez} [N/cm]

z_e

z_{emax}

z_{emax}

z_{emax}

b [cm]

= peripheral force

= specific load

= number of teeth in mesh in the small pulley

= max. no of teeth in mesh to be considered for the calculation of the drive

= 12 for ELATECH® M

= 6 for ELATECH® V

= belt width in cm

PROFILE	Belt width b	ARAMID CORD	
	Code /mm	F _{Tzul} [N] M type	F _{Br} [N]
XL	025 / 6,35	420	1680
	031 / 7,94	490	1960
	037 / 9,53	630	2520
	050 / 12,7	910	3640
	075 / 19,1	1470	5880
	100 / 25,4	1960	7840
	150 / 38,1	3080	12320
	200 / 50,8	4130	16520
	400/101,6	8400	33600

Flexibility

Minimum pulley number of teeth and minimum idler diameter			
XL		TYPE OF CORD	
		STANDARD	ARAMID
 Drive without reverse bending	Timing pulley z _{min}	10	10
	Idler running on belt teeth d _{min}	30 mm	30 mm
 Drive with reverse bending	Timing pulley z _{min}	15	15
	Idler running on belt back d _{min}	30 mm	30 mm

Timing pulleys

z	da	dw	z	da	dw	z	da	dw	z	da	dw
10	15,66	16,17	39	62,55	63,06	68	109,45	109,96	97	156,34	156,85
11	17,28	17,79	40	64,17	64,68	69	111,06	111,57	98	157,96	158,47
12	18,89	19,40	41	65,79	66,30	70	112,68	113,19	99	159,57	160,08
13	20,51	21,02	42	67,40	67,91	71	114,30	114,81	100	161,19	161,70
14	22,13	22,64	43	69,02	69,53	72	115,92	116,43	101	162,81	163,32
15	23,74	24,25	44	70,64	71,15	73	117,53	118,04	102	164,42	164,93
16	25,36	25,87	45	72,26	72,77	74	119,15	119,66	103	166,04	166,55
17	26,98	27,49	46	73,87	74,38	75	120,77	121,28	104	167,66	168,17
18	28,60	29,11	47	75,49	76,00	76	122,38	122,89	105	169,28	169,79
19	30,21	30,72	48	77,11	77,62	77	124,00	124,51	106	170,89	171,40
20	31,83	32,34	49	78,72	79,23	78	125,62	126,13	107	172,51	173,02
21	33,45	33,96	50	80,34	80,85	79	127,23	127,74	108	174,13	174,64
22	35,06	35,57	51	81,96	82,47	80	128,85	129,36	109	175,74	176,25
23	36,68	37,19	52	83,57	84,08	81	130,47	130,98	110	177,36	177,87
24	38,30	38,81	53	85,19	85,70	82	132,08	132,59	111	178,98	179,49
25	39,92	40,43	54	86,81	87,32	83	133,70	134,21	112	180,59	181,10
26	41,53	42,04	55	88,42	88,93	84	135,32	135,83	113	182,21	182,72
27	43,15	43,66	56	90,04	90,55	85	136,93	137,44	114	183,83	184,34
28	44,77	45,28	57	91,66	92,17	86	138,55	139,06	115	185,44	185,95
29	46,38	46,89	58	93,28	93,79	87	140,17	140,68	116	187,06	187,57
30	48,00	48,51	59	94,89	95,40	88	141,75	142,30	117	188,68	189,19
31	49,62	50,13	60	96,51	97,02	89	143,36	143,91	118	190,30	190,81
32	51,23	51,74	61	98,13	98,64	90	145,02	145,53	119	191,91	192,42
33	52,85	53,36	62	99,74	100,25	91	146,64	147,15	120	193,53	194,04
34	54,47	54,98	63	101,36	101,87	92	148,25	148,76			
35	56,09	56,60	64	102,98	103,49	93	149,87	150,38			
36	57,70	58,21	65	104,60	105,11	94	151,49	152,00			
37	59,32	59,83	66	106,21	106,72	95	153,11	153,62			
38	60,94	61,45	67	107,83	108,34	96	154,72	155,23			

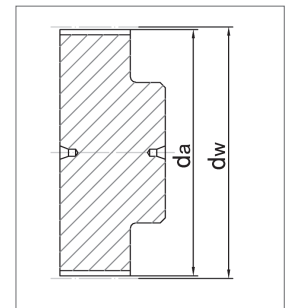

L

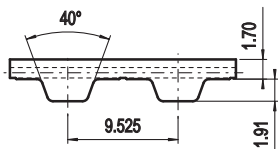

Belt characteristics

- Polyurethane timing belt with trapezoidal tooth profile according to DIN/ISO 5296 with steel tension cords
- Imperial pitch 3/8" = 9,525 mm
- Allow to use small diameter pulley
- Mainly used in applications where inch pitch is an advantage (USA / UK)

- Width tolerance: ±0,5 [mm]
- Length tolerance: ±0,5 [mm/m]
- Thickness tolerance: ±0,2 [mm]

Technical data

Belt width b Code / mm	Allowable tensile load Type M F _{Tzul} [N]	Allowable tensile load Type V F _{Tzul} [N]	Breaking load Type M F _{Br} [N]	Specific spring rate C _{spez} [N]	Weight [kg/m]
050 / 12,7	1270	635	4620	317500	0,049
075 / 19,1	1960	980	7140	490000	0,073
100 / 25,4	2760	1380	10080	690000	0,098
150 / 38,1	4140	2070	15120	1035000	0,146
200 / 50,8	5640	2820	20580	1410000	0,195
300 / 76,2	8510	4255	31080	2127500	0,293
400 / 101,6	11390	5695	41580	2847500	0,390

Load / Elongation [%]

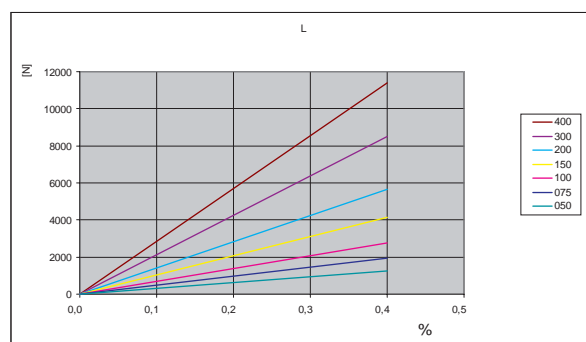

Other widths are available on request.

Tooth shear strength

rpm	F _{Uspez} [N/cm]	rpm	F _{Uspez} [N/cm]	rpm	F _{Uspez} [N/cm]	rpm	F _{Uspez} [N/cm]
0	38,60	800	24,70	1900	19,66	4500	14,36
20	37,42	900	24,04	2000	19,35	5000	13,70
40	36,40	1000	23,44	2200	18,77	5500	13,10
60	35,51	1100	22,89	2400	18,24	6000	12,55
80	34,74	1200	22,38	2600	17,76	6500	12,05
100	34,07	1300	21,91	2800	17,30	7000	11,58
200	31,59	1400	21,48	3000	16,88	7500	11,14
300	29,79	1440	21,31	3200	16,48	8000	10,73
400	28,39	1500	21,07	3400	16,10	8500	10,35
500	27,25	1600	20,69	3600	15,75	9000	9,98
600	26,28	1700	20,33	3800	15,41	9500	9,64
700	25,44	1800	19,98	4000	15,09	10000	9,31

Tooth shear strength / rpm

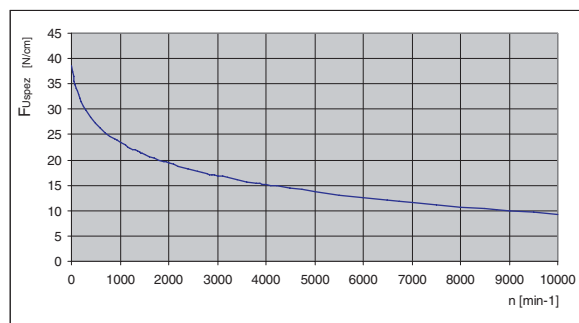

The specific load F_{Uspez} is the maximum load which one single belt tooth 1 cm wide can withstand in all operating conditions. This force is related to the drive rpm. The total load F_U transmissible by the belt in the drive is calculated by:

$$F_U [N] = F_{Uspez} \cdot z_e \cdot b$$

- F_U [N] = peripheral force
- F_{Uspez} [N/cm] = specific load
- z_e = number of teeth in mesh in the small pulley
- z_{emax} = max. no of teeth in mesh to be considered for the calculation of the drive
- z_{emax} = 12 for ELATECH® M
- z_{emax} = 6 for ELATECH® V
- b [cm] = belt width in cm

Specialties

PROFILE	Belt width b Code / mm	ARAMID CORD		STAINLESS STEEL	
		F _{Tzul} [N] M type	F _{Br} [N]	F _{Tzul} [N] M type	F _{Br} [N]
L	050 / 12,7	1210	4950	830	3300
	075 / 19,1	1870	7650	1280	5100
	100 / 25,4	2640	10800	1800	7200
	150 / 38,1	3960	16200	2700	10800
	200 / 50,8	5390	22050	3680	14700
	300 / 76,2	8140	33300		
	400 / 101,6	10890	44550		

Flexibility

Minimum pulley number of teeth and minimum idler diameter				
L		TYPE OF CORD		
		STANDARD	ARAMID	STAINLESS
	Drive without reverse bending			
	Timing pulley z _{min}	15	15	18
	Idler running on belt teeth d _{min}	60 mm	60 mm	65 mm
	Drive with reverse bending			
	Timing pulley z _{min}	20	20	20
	Idler running on belt back d _{min}	60 mm	60 mm	65 mm

Timing pulleys

z	da	dw	z	da	dw	z	da	dw	z	da	dw
10	29,56	30,32	39	117,47	118,24	68	205,41	206,17	97	293,33	294,09
11	32,59	33,35	40	120,52	121,27	69	208,44	209,20	98	296,36	297,12
12	35,62	36,38	41	123,55	124,30	70	211,47	212,23	99	299,40	300,15
13	38,65	39,41	42	126,58	127,33	71	214,50	215,26	100	302,43	303,18
14	41,68	42,44	43	129,61	130,36	72	217,53	218,29	101	305,46	306,21
15	44,71	45,47	44	132,64	133,39	73	220,56	221,32	102	308,49	309,24
16	47,74	48,50	45	135,67	136,44	74	223,59	224,35	103	311,52	312,29
17	50,77	51,53	46	138,70	139,47	75	226,62	227,38	104	314,55	315,32
18	53,80	54,56	47	141,73	142,50	76	229,65	230,41	105	317,58	318,35
19	56,83	57,61	48	144,76	145,53	77	232,70	233,46	106	320,61	321,38
20	59,88	60,64	49	147,80	148,56	78	235,73	236,49	107	323,64	324,41
21	62,91	63,67	50	150,83	151,59	79	238,76	239,52	108	326,69	327,44
22	65,94	66,70	51	153,86	154,62	80	241,79	242,55	109	329,72	330,47
23	68,97	69,73	52	156,89	157,65	81	244,82	245,58	110	332,75	333,50
24	72,00	72,76	53	159,92	160,68	82	247,85	248,61	111	335,78	336,53
25	75,03	75,80	54	162,95	163,71	83	250,88	251,64	112	338,81	339,56
26	78,06	78,83	55	166,00	166,76	84	253,91	254,67	113	341,84	342,61
27	81,09	81,86	56	169,03	169,79	85	256,94	257,70	114	344,87	345,64
28	84,12	84,89	57	172,06	172,82	86	259,97	260,73	115	347,90	348,67
29	87,15	87,92	58	175,09	175,85	87	263,02	263,78	116	350,93	351,70
30	90,20	90,95	59	178,12	178,88	88	266,05	266,81	117	353,96	354,73
31	93,23	93,98	60	181,15	181,91	89	269,08	269,84	118	357,00	357,76
32	96,26	97,01	61	184,18	184,94	90	272,11	272,87	119	360,03	360,79
33	99,29	100,04	62	187,21	187,97	91	275,14	275,90	120	363,07	363,82
34	102,32	103,07	63	190,24	191,00	92	278,17	278,93			
35	105,35	106,12	64	193,27	194,03	93	281,20	281,96			
36	108,38	109,15	65	196,30	197,06	94	284,23	285,00			
37	111,41	112,18	66	199,33	200,11	95	287,26	288,03			
38	114,44	115,21	67	202,38	203,14	96	290,30	291,06			

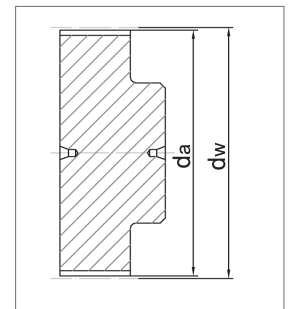

H

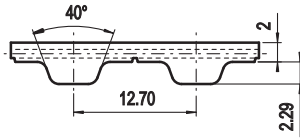

Belt characteristics

- Polyurethane timing belt with trapezoidal tooth profile according to DIN/ISO 5296 with steel tension cords
- Imperial pitch 1/2" = 12,7 mm
- Allow to use small diameter pulley
- Mainly used in applications where inch pitch is an advantage (USA / UK)

- Width tolerance: ±0,5 [mm]
- Length tolerance: ±0,5 [mm/m]
- Thickness tolerance: ±0,2 [mm]

Technical data

Belt width b	Allowable tensile load Type M F _{Tzul} [N]	Allowable tensile load Type V F _{Tzul} [N]	Breaking load Type M F _{Br} [N]	Specific spring rate C _{spez} [N]	Weight [kg/m]
Code /mm					
050 / 12,7	1270	635	4620	317500	0,05
075 / 19,1	1960	980	7140	490000	0,08
100 / 25,4	2760	1380	10080	690000	0,11
150 / 38,1	4140	2070	15120	1035000	0,16
200 / 50,8	5640	2820	20580	1410000	0,22
300 / 76,2	8510	4255	31080	2127500	0,32
400/101,6	11390	5695	41580	2847500	0,43
600/152,4	17250	8625	63000	4312500	0,65
800/203,2	11390	5695	41580	2847500	0,56

Load / Elongation [%]

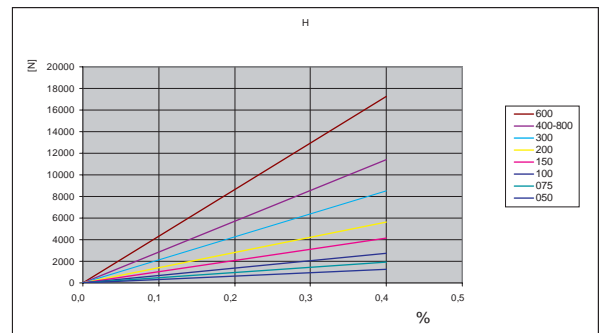

Other widths are available on request.

Tooth shear strength

rpm	F _{Uspez} [N/cm]	rpm	F _{Uspez} [N/cm]	rpm	F _{Uspez} [N/cm]	rpm	F _{Uspez} [N/cm]
0	45,30	800	29,04	1900	23,11	4500	16,88
20	43,95	900	28,26	2000	22,74	5000	16,11
40	42,78	1000	27,55	2200	22,07	5500	15,41
60	41,77	1100	26,90	2400	21,44	6000	14,76
80	40,88	1200	26,31	2600	20,87	6500	14,17
100	40,11	1300	25,76	2800	20,34	7000	13,62
200	37,22	1400	25,25	3000	19,84	7500	13,11
300	35,07	1440	25,05	3200	19,37	8000	12,63
400	33,41	1500	24,77	3400	18,93	8500	12,18
500	32,05	1600	24,32	3600	18,51	9000	11,75
600	30,90	1700	23,89	3800	18,12	9500	11,35
700	29,91	1800	23,49	4000	17,75	10000	10,96

Tooth shear strenght / rpm

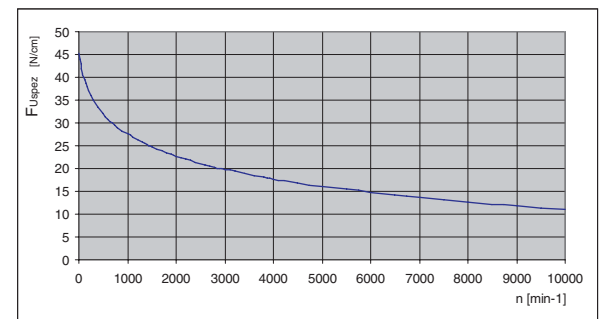

The specific load F_{Uspez} is the maximum load which one single belt tooth 1 cm wide can withstand in all operating conditions. This force is related to the drive rpm. The total load F_U transmissible by the belt in the drive is calculated by:

$$F_U [N] = F_{Uspez} \cdot Z_e \cdot b$$

- F_U [N] = peripheral force
- F_{Uspez} [N/cm] = specific load
- Z_e = number of teeth in mesh in the small pulley
- Z_{emax} = max. no of teeth in mesh to be considered for the calculation of the drive
- Z_{emax} = 12 for ELATECH® M
- Z_{emax} = 6 for ELATECH® V
- b [cm] = belt width in cm

Specialties

PROFILE	Belt width b Code /mm	ARAMID CORD		STAINLESS STEEL	
		F _{Tzul} [N] M type	F _{Br} [N]	F _{Tzul} [N] M type	F _{Br} [N]
H	050 / 12,7	1210	4950	830	3300
	075 / 19,1	1870	7650	1280	5100
	100 / 25,4	2640	10800	1800	7200
	150 / 38,1	3960	16200	2700	10800
	200 / 50,8	5390	22050	3680	14700
	300 / 76,2	8140	33300		
	400/101,6	10890	44550		
	600/152,4	16500	67500		
800/203,2	11000	45000			

Flexibility

Minimum pulley number of teeth and minimum idler diameter				
H		TYPE OF CORD		
		STANDARD	ARAMID	STAINLESS
 Drive without reverse bending	Timing pulley z _{min}	14	14	15
	Idler running on belt teeth d _{min}	60 mm	60 mm	65 mm
 Drive with reverse bending	Timing pulley z _{min}	20	20	20
	Idler running on belt back d _{min}	80 mm	80 mm	80 mm

Timing pulleys

z	da	dw	z	da	dw	z	da	dw	z	da	dw
14	55,23	56,60	43	172,46	173,82	72	289,68	291,05	101	406,92	408,28
15	59,27	60,64	44	176,50	177,86	73	293,72	295,10	102	410,96	412,34
16	63,31	64,68	45	180,54	181,90	74	297,78	299,14	103	415,00	416,38
17	67,35	68,72	46	184,58	185,96	75	301,82	303,18	104	419,04	420,42
18	71,40	72,76	47	188,62	190,00	76	305,86	307,22	105	423,08	424,46
19	75,44	76,80	48	192,67	194,04	77	309,90	311,26	106	427,14	428,50
20	79,48	80,84	49	196,71	198,08	78	313,94	315,32	107	431,18	432,54
21	83,52	84,88	50	200,75	202,13	79	317,98	319,36	108	435,22	436,58
22	87,57	88,94	51	204,80	206,17	80	322,02	323,40	109	439,26	440,62
23	91,61	92,98	52	208,84	210,21	81	326,06	327,44	110	443,30	444,68
24	95,65	97,02	53	212,88	214,25	82	330,12	331,48	111	447,34	448,72
25	99,69	101,06	54	216,92	218,29	83	334,16	335,52	112	451,38	452,76
26	103,73	105,10	55	220,96	222,33	84	338,20	339,56	113	455,42	456,80
27	107,77	109,14	56	225,00	226,37	85	342,24	343,60	114	459,48	460,84
28	111,81	113,18	57	229,04	230,41	86	346,28	347,66	115	463,52	464,88
29	115,85	117,22	58	233,10	234,47	87	350,33	351,70	116	467,56	468,92
30	119,91	121,28	59	237,14	238,51	88	354,37	355,74	117	471,60	472,96
31	123,95	125,32	60	241,18	242,55	89	358,41	359,78	118	475,64	477,02
32	127,99	129,36	61	245,22	246,59	90	362,45	363,82	119	479,68	481,06
33	132,03	133,40	62	249,26	250,63	91	366,50	367,86	120	483,72	485,10
34	136,07	137,44	63	253,30	254,67	92	370,54	371,90			
35	140,11	141,48	64	257,34	258,71	93	374,58	375,94			
36	144,15	145,52	65	261,38	262,75	94	378,62	380,00			
37	148,20	149,56	66	265,44	266,81	95	382,66	384,04			
38	152,24	153,62	67	269,48	270,85	96	386,70	388,08			
39	156,28	157,66	68	273,52	274,89	97	390,74	392,12			
40	160,32	161,70	69	277,56	278,93	98	394,80	396,16			
41	164,36	165,74	70	281,60	282,97	99	398,84	400,20			
42	168,42	169,78	71	285,64	287,01	100	402,88	404,24			

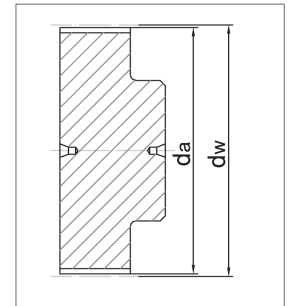

XH

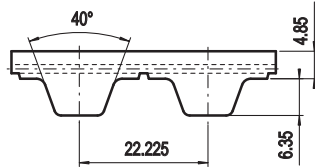

Belt characteristics

- Polyurethane timing belt with trapezoidal tooth profile according to DIN/ISO 5296 with steel tension cords
- Imperial pitch $7/8'' = 22,225$ mm
- Mainly used in applications where inch pitch is an advantage (USA / UK)

- Width tolerance: $\pm 1,0$ [mm]
- Length tolerance: $\pm 0,5$ [mm/m]
- Thickness tolerance: $\pm 0,4$ [mm]

Technical data

Belt width b Code /mm	Allowable tensile load Type M F_{Tzul} [N]	Allowable tensile load Type V F_{Tzul} [N]	Breaking load Type M F_{Br} [N]	Specific spring rate C_{spez} [N]	Weight [kg/m]
100 / 25,4	3920	1960	15200	980000	0,26
200 / 50,8	8330	4165	32300	2082500	0,54
300 / 76,2	12740	6370	49400	3185000	0,80
400 / 101,6	17150	8575	66500	4287500	1,06
600 / 152,4	25970	12985	100700	6492500	1,54

Load / Elongation [%]

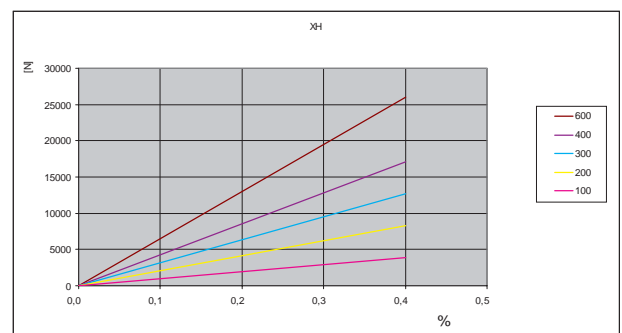

Other widths are available on request.

Tooth shear strength

rpm	F_{Uspez} [N/cm]	rpm	F_{Uspez} [N/cm]	rpm	F_{Uspez} [N/cm]	rpm	F_{Uspez} [N/cm]
0	96,00	800	55,99	1900	43,86	4000	33,31
20	92,98	900	54,35	2000	43,14		
40	90,27	1000	52,88	2200	41,79		
60	87,85	1100	51,55	2400	40,56		
80	85,68	1200	50,33	2600	39,43		
100	83,73	1300	49,20	2800	38,37		
200	74,80	1400	48,16	2880	37,98		
300	69,42	1440	47,77	3000	37,40		
400	65,53	1500	47,19	3200	36,48		
500	62,48	1600	46,29	3400	35,62		
600	59,97	1700	45,43	3600	34,81		
700	57,84	1800	44,62	3800	34,04		

Tooth shear strength / rpm

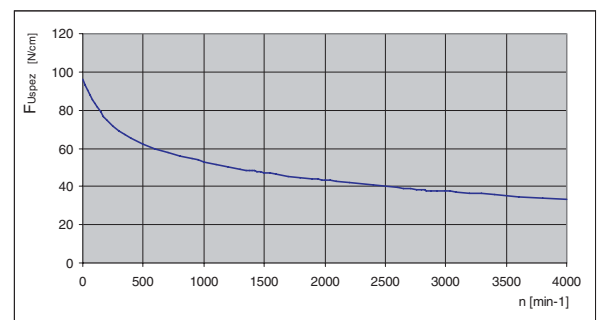

The specific load F_{Uspez} is the maximum load which one single belt tooth 1 cm wide can withstand in all operating conditions. This force is related to the drive rpm. The total load F_U transmissible by the belt in the drive is calculated by:

$$F_U [N] = F_{Uspez} \cdot z_e \cdot b$$

- F_U [N] = peripheral force
- F_{Uspez} [N/cm] = specific load
- z_e = number of teeth in mesh in the small pulley
- z_{emax} = max. no of teeth in mesh to be considered for the calculation of the drive
- $z_{emax} = 12$ for ELATECH® M
- $z_{emax} = 6$ for ELATECH® V
- b [cm] = belt width in cm

Specialties

PROFILE	Belt width b Code / mm	ARAMID CORD		STAINLESS STEEL	
		F _{Tzul} [N] M type	F _{Br} [N]	F _{Tzul} [N] M type	F _{Br} [N]
XH	100 / 25,4	3040	12640	2880	12000
	200 / 50,8	6460	26860	6120	25500
	300 / 76,2	9880	41080		
	400 / 101,6	13300	55300		
	600 / 152,4	20140	83740		

Flexibility

Minimum pulley number of teeth and minimum idler diameter					
XH		TYPE OF CORD			
		STANDARD	ARAMID	STAINLESS	
Drive without reverse bending		Timing pulley z _{min}	18	18	20
		Idler running on belt teeth d _{min}	150 mm	150 mm	160 mm
Drive with reverse bending		Timing pulley z _{min}	20	20	22
		Idler running on belt back d _{min}	180 mm	180 mm	180 mm

Timing pulleys

z	da	dw	z	da	dw	z	da	dw	z	da	dw
18	127,34	124,55	47	332,49	329,70	76	537,65	534,84	105	742,80	740,01
19	134,41	131,62	48	339,57	336,77	77	544,72	541,93	106	749,87	747,08
20	141,48	138,68	49	346,66	343,87	78	551,79	549,00	107	756,96	754,15
21	148,55	145,76	50	353,73	350,93	79	558,88	556,07	108	764,03	761,22
22	155,64	152,84	51	360,80	358,00	80	565,95	563,15	109	771,10	768,30
23	162,71	159,91	52	367,87	365,07	81	573,02	570,22	110	778,17	775,37
24	169,78	167,00	53	374,94	372,14	82	580,09	577,29	111	785,26	782,44
25	176,85	174,07	54	382,01	379,21	83	587,18	584,36	112	792,33	789,51
26	183,94	181,13	55	389,08	386,30	84	594,25	591,43	113	799,40	796,60
27	191,01	188,20	56	396,17	393,37	85	601,32	598,60	114	806,47	803,67
28	198,08	195,27	57	403,24	400,44	86	608,39	605,61	115	813,54	810,74
29	205,15	202,37	58	410,31	407,51	87	615,46	612,68	116	820,63	817,81
30	212,22	209,44	59	417,38	414,58	88	622,55	619,75	117	827,70	824,88
31	219,31	216,51	60	424,47	421,68	89	629,62	626,82	118	834,77	831,95
32	226,38	223,58	61	431,54	428,75	90	636,69	633,89	119	841,84	839,03
33	233,45	230,66	62	438,61	435,90	91	643,76	640,96	120	848,93	846,12
34	240,52	237,73	63	445,68	442,90	92	650,85	648,04			
35	247,59	244,80	64	452,75	449,97	93	657,92	655,11			
36	254,68	251,87	65	459,84	457,05	94	664,99	662,18			
37	261,75	258,94	66	466,91	464,10	95	672,06	669,25			
38	268,82	266,02	67	473,98	471,20	96	679,13	676,33			
39	275,89	273,11	68	481,05	478,25	97	686,22	683,40			
40	282,98	280,18	69	488,12	485,32	98	693,29	690,47			
41	290,05	287,25	70	495,21	492,39	99	700,36	697,55			
42	297,12	294,33	71	502,28	499,48	100	707,43	704,62			
43	304,19	301,40	72	509,35	506,57	101	714,50	711,70			
44	311,26	308,47	73	516,42	513,63	102	721,59	718,77			
45	318,35	315,54	74	523,51	520,70	103	728,66	725,85			
46	325,42	322,61	75	530,58	527,77	104	735,73	732,92			

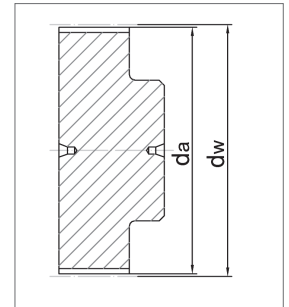

HTD3M

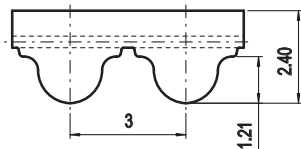

Belt characteristics

- Polyurethane timing belt with round tooth profile and high tensile load tension cords. Produced according to ISO 13050
- Metric pitch 3 mm
- The round tooth profile allows a uniform load distribution that guarantees high performances, high transmissible torque and precise tooth engagement.
- Widely used in linear positioning, light power transmission applications.

- Width tolerance: $\pm 0,5$ [mm]
- Length tolerance: $\pm 0,5$ [mm/m]
- Thickness tolerance: $\pm 0,2$ [mm]

Technical data

Belt width b [mm]	Allowable tensile load Type M F_{Tzul} [N]	Allowable tensile load Type V F_{Tzul} [N]	Breaking load Type M F_{Br} [N]	Specific spring rate C_{spez} [N]	Weight [kg/m]
10	320	160	1250	80000	0,02
15	510	255	2000	127500	0,03
25	900	450	3500	225000	0,05
50	1860	930	7250	465000	0,10
100	3780	1890	14750	945000	0,20

Load / Elongation [%]

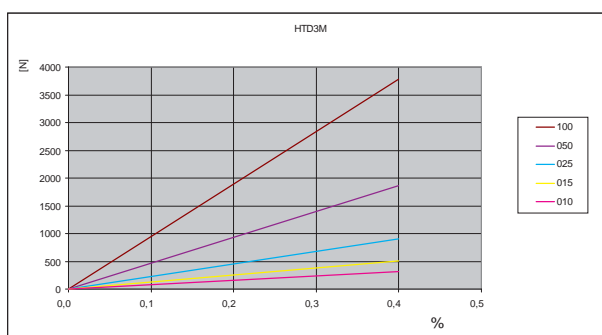

Other widths are available on request.

Tooth shear strength

rpm	F_{Uspez} [N/cm]	rpm	F_{Uspez} [N/cm]	rpm	F_{Uspez} [N/cm]	rpm	F_{Uspez} [N/cm]
0	25,20	800	17,30	1900	12,67	4500	7,05
20	24,60	900	16,75	2000	12,36	5000	6,32
40	24,06	1000	16,24	2200	11,77	5500	5,66
60	23,57	1100	15,75	2400	11,22	6000	5,04
80	23,12	1200	15,29	2600	10,71	6500	4,47
100	22,72	1300	14,86	2800	10,24	7000	3,94
200	21,22	1400	14,45	3000	9,79	7500	3,44
300	20,31	1440	14,29	3200	9,36	8000	2,98
400	19,75	1500	14,06	3400	8,96	8500	2,54
500	19,14	1600	13,69	3600	8,57	9000	2,12
600	18,50	1700	13,33	3800	8,21	9500	1,72
700	17,88	1800	12,99	4000	7,86	10000	1,35

Tooth shear strength / rpm

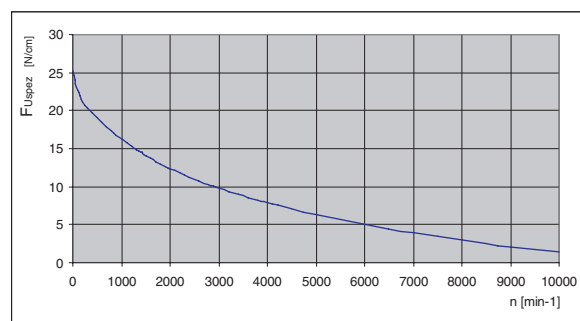

The specific load F_{Uspez} is the maximum load which one single belt tooth 1 cm wide can withstand in all operating conditions. This force is related to the drive rpm. The total load F_U transmissible by the belt in the drive is calculated by:

$$F_U [N] = F_{Uspez} \cdot z_e \cdot b$$

- F_U [N] = peripheral force
- F_{Uspez} [N/cm] = specific load
- z_e = number of teeth in mesh in the small pulley
- z_{emax} = max. no of teeth in mesh to be considered for the calculation of the drive
- z_{emax} = 12 for ELATECH® M
- z_{emax} = 6 for ELATECH® V
- b [cm] = belt width in cm

Flexibility

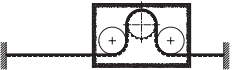
Minimum pulley number of teeth and minimum idler diameter		
HTD3M		TYPE OF CORD
		STANDARD
Drive without reverse bending 	Timing pulley z_{min}	16
	Idler running on belt teeth d_{min}	30 mm
Drive with reverse bending 	Timing pulley z_{min}	20
	Idler running on belt back d_{min}	30 mm

Timing pulleys

z	da	dw	z	da	dw	z	da	dw	z	da	dw
10	8,79	9,55	43	40,30	41,06	76	71,82	72,58	109	103,33	104,09
11	9,74	10,50	44	41,26	42,02	77	72,77	73,53	110	104,29	105,05
12	10,70	11,46	45	42,21	42,97	78	73,73	74,49	111	105,24	106,00
13	11,65	12,41	46	43,17	43,93	79	74,68	75,44	112	106,20	106,96
14	12,61	13,37	47	44,12	44,88	80	75,64	76,40	113	107,15	107,91
15	13,56	14,32	48	45,08	45,84	81	76,59	77,35	114	108,11	108,87
16	14,52	15,28	49	46,03	46,79	82	77,55	78,31	115	109,06	109,82
17	15,47	16,23	50	46,99	47,75	83	78,50	79,26	116	110,02	110,78
18	16,43	17,19	51	47,94	48,70	84	79,46	80,22	117	110,97	111,73
19	17,38	18,14	52	48,90	49,66	85	80,41	81,17	118	111,93	112,69
20	18,34	19,10	53	49,85	50,61	86	81,37	82,13	119	112,88	113,64
21	19,29	20,05	54	50,81	51,57	87	82,32	83,08	120	113,83	114,59
22	20,25	21,01	55	51,76	52,52	88	83,28	84,04	121	114,79	115,55
23	21,20	21,96	56	52,72	53,48	89	84,23	84,99	122	115,74	116,50
24	22,16	22,92	57	53,67	54,43	90	85,19	85,95	123	116,70	117,46
25	23,11	23,87	58	54,63	55,39	91	86,14	86,90	124	117,65	118,41
26	24,07	24,83	59	55,58	56,34	92	87,10	87,86	125	118,61	119,37
27	25,02	25,78	60	56,54	57,30	93	88,05	88,81	126	119,56	120,32
28	25,98	26,74	61	57,49	58,25	94	89,01	89,77	127	120,52	121,28
29	26,93	27,69	62	58,45	59,21	95	89,96	90,72	128	121,47	122,23
30	27,89	28,65	63	59,40	60,16	96	90,92	91,68	129	122,43	123,19
31	28,84	29,60	64	60,36	61,12	97	91,87	92,63	130	123,38	124,14
32	29,80	30,56	65	61,31	62,07	98	92,83	93,59	131	124,34	125,10
33	30,75	31,51	66	62,27	63,03	99	93,78	94,54	132	125,29	126,05
34	31,71	32,47	67	63,22	63,98	100	94,74	95,50	133	126,25	127,01
35	32,66	33,42	68	64,18	64,94	101	95,69	96,45	134	127,20	127,96
36	33,62	34,38	69	65,13	65,89	102	96,65	97,41	135	128,16	128,92
37	34,57	35,33	70	66,09	66,85	103	97,60	98,36	136	129,11	129,87
38	35,53	36,29	71	67,04	67,80	104	98,56	99,32	137	130,07	130,83
39	36,48	37,24	72	68,00	68,76	105	99,51	100,27	138	131,02	131,78
40	37,44	38,20	73	68,95	69,71	106	100,47	101,23	139	131,98	132,74
41	38,39	39,15	74	69,91	70,67	107	101,42	102,18	140	132,93	133,69
42	39,35	40,11	75	70,86	71,62	108	102,38	103,14			

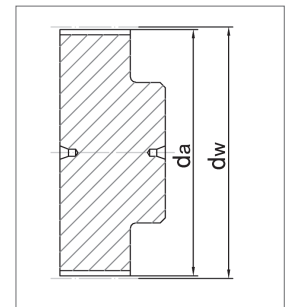

HTD5M

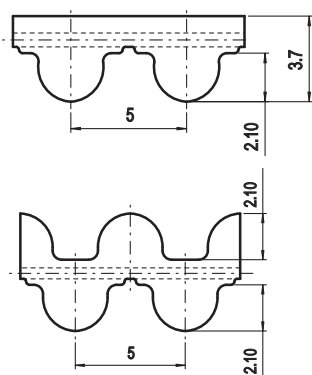

Belt characteristics

- Polyurethane timing belt with round tooth profile and high tensile load tension cords. Produced according to ISO 13050
 - Metric pitch 5 mm
 - The round tooth profile allows a uniform load distribution that guarantees high performances, high transmissible torque and precise tooth engagement.
 - Widely used in linear positioning, light power transmission applications.
 - Double sided tooth construction available
- Width tolerance: $\pm 0,5$ [mm]
 - Length tolerance: $\pm 0,5$ [mm/m]
 - Thickness tolerance: $\pm 0,2$ [mm]

Technical data

Belt width b [mm]	Allowable tensile load Type M F_{Tzul} [N]	Allowable tensile load Type V F_{Tzul} [N]	Breaking load Type M F_{Br} [N]	Specific spring rate C_{spez} [N]	Weight [kg/m]
10	920	460	3360	230000	0,05
15	1500	750	5460	375000	0,07
25	2650	1325	9660	662500	0,12
50	5520	2760	20160	1380000	0,24
100	11270	5635	41160	2817500	0,48

Load / Elongation [%]

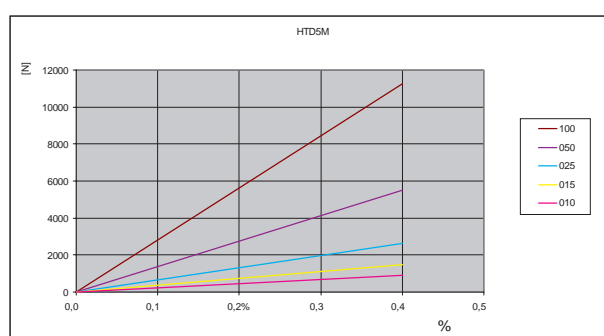

Other widths are available on request.

Tooth shear strength

rpm	F_{Uspez} [N/cm]	rpm	F_{Uspez} [N/cm]	rpm	F_{Uspez} [N/cm]	rpm	F_{Uspez} [N/cm]
0	36,80	800	27,21	1900	22,24	4500	16,40
20	36,25	900	26,61	2000	21,91	5000	15,64
40	35,75	1000	26,05	2200	21,30	5500	14,95
60	35,30	1100	25,52	2400	20,72	6000	14,32
80	34,89	1200	25,03	2600	20,19	6500	13,74
100	34,52	1300	24,56	2800	19,69	7000	13,19
200	33,13	1400	24,13	3000	19,23	7500	12,68
300	30,87	1440	23,96	3200	18,78	8000	12,20
400	30,10	1500	23,71	3400	18,37	8500	11,75
500	29,31	1600	23,32	3600	17,97	9000	11,33
600	28,56	1700	22,94	3800	17,59	9500	10,92
700	27,86	1800	22,58	4000	17,23	10000	10,53

Tooth shear strength / rpm

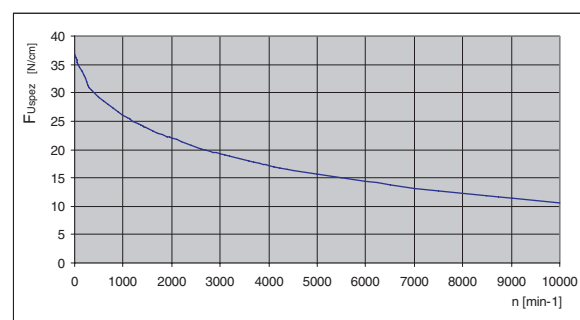

The specific load F_{Uspez} is the maximum load which one single belt tooth 1 cm wide can withstand in all operating conditions. This force is related to the drive rpm. The total load F_U transmissible by the belt in the drive is calculated by:



$$F_U [N] = F_{Uspez} \cdot z_e \cdot b$$

- F_U [N] = peripheral force
- F_{Uspez} [N/cm] = specific load
- z_e = number of teeth in mesh in the small pulley
- z_{emax} = max. no of teeth in mesh to be considered for the calculation of the drive
- $z_{emax} = 12$ for ELATECH® M
- $z_{emax} = 6$ for ELATECH® V
- b [cm] = belt width in cm

Specialties

PROFILE	Belt width b [mm]	ARAMID CORD		STAINLESS STEEL	
		F _{Tzul} [N] M type	F _{Br} [N]	F _{Tzul} [N] M type	F _{Br} [N]
HTD5M	010	880	3600	600	2400
	015	1430	5850	980	3900
	025	2530	10350	1730	6900
	050	5280	21600	3600	14400
	100	10780	44100		

Flexibility

Minimum pulley number of teeth and minimum idler diameter				
HTD5M		TYPE OF CORD		
		STANDARD	ARAMID	STAINLESS
Drive without reverse bending 	Timing pulley z _{min}	16	16	18
	Idler running on belt teeth d _{min}	50 mm	50 mm	60 mm
Drive with reverse bending 	Timing pulley z _{min}	20	20	20
	Idler running on belt back d _{min}	50 mm	50	60 mm

Timing pulleys

z	da	dw	z	da	dw	z	da	dw	z	da	dw
10	14,77	15,91	39	60,93	62,07	68	107,08	108,22	97	153,24	154,38
11	16,36	17,50	40	62,52	63,66	69	108,67	109,81	98	154,83	155,97
12	17,96	19,10	41	64,11	65,25	70	110,27	111,41	99	156,42	157,56
13	19,55	20,69	42	65,70	66,84	71	111,86	113,00	100	158,01	159,15
14	21,14	22,28	43	67,29	68,43	72	113,45	114,59	101	159,61	160,75
15	22,73	23,87	44	68,88	70,02	73	115,04	116,18	102	161,20	162,34
16	24,32	25,46	45	70,47	71,61	74	116,63	117,77	103	162,81	163,95
17	25,91	27,05	46	72,06	73,20	75	118,22	119,36	104	164,38	165,52
18	27,51	28,65	47	73,65	74,79	76	119,81	120,95	105	165,97	167,11
19	29,09	30,23	48	75,24	76,38	77	121,40	122,54	106	167,56	168,70
20	30,69	31,83	49	76,84	77,98	78	122,99	124,13	107	169,09	170,23
21	32,28	33,42	50	78,44	79,58	79	124,58	125,72	108	170,75	171,89
22	33,87	35,01	51	80,03	81,17	80	126,18	127,32	109	172,34	173,48
23	35,46	36,60	52	81,62	82,76	81	127,77	128,91	110	173,93	175,07
24	37,06	38,20	53	83,21	84,35	82	129,36	130,50	111	175,52	176,66
25	38,64	39,78	54	84,80	85,94	83	130,95	132,09	112	177,11	178,25
26	40,24	41,38	55	86,39	87,53	84	132,54	133,68	113	178,70	179,84
27	41,83	42,97	56	87,98	89,12	85	134,14	135,28	114	180,29	181,43
28	43,42	44,56	57	89,57	90,71	86	135,73	136,87	115	181,88	183,02
29	45,01	46,15	58	91,17	92,31	87	137,32	138,46	116	183,47	184,61
30	46,61	47,75	59	92,76	93,90	88	138,91	140,05	117	185,07	186,21
31	48,19	49,33	60	94,35	95,49	89	140,51	141,65	118	186,66	187,80
32	49,79	50,93	61	95,94	97,08	90	142,10	143,24	119	188,25	189,39
33	51,38	52,52	62	97,53	98,67	91	143,69	144,83	120	189,84	190,98
34	52,97	54,11	63	99,12	100,26	92	145,28	146,42			
35	54,56	55,70	64	100,72	101,86	93	146,87	148,01			
36	56,16	57,30	65	102,31	103,45	94	148,46	149,60			
37	57,75	58,89	66	103,90	105,04	95	150,06	151,20			
38	59,34	60,48	67	105,49	106,63	96	151,64	152,78			

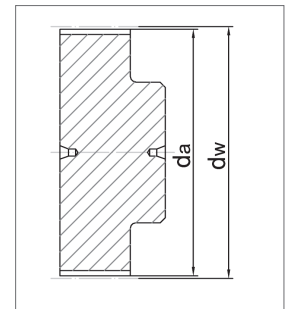

HTD8M

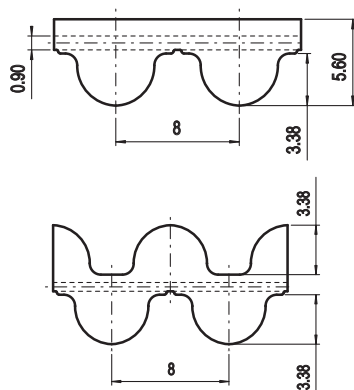

Belt characteristics

- Polyurethane timing belt with round tooth profile and high tensile load tension cords. Produced according to ISO 13050
- Metric pitch 8 mm
- The round tooth profile allows a uniform load distribution that guarantees high performances, high transmissible torque and precise tooth engagement
- Widely used in linear positioning, medium power transmission applications.
- Double sided tooth construction available

- Width tolerance: $\pm 0,5$ [mm]
- Length tolerance: $\pm 0,5$ [mm/m]
- Thickness tolerance: $\pm 0,2$ [mm]

Technical data

Belt width b [mm]	Allowable tensile load Type M F_{Tzul} [N]	Allowable tensile load Type V F_{Tzul} [N]	Breaking load Type M F_{Br} [N]	Specific spring rate C_{spez} [N]	Weight [kg/m]
10	1470	735	5700	367500	0,07
15	2210	1105	8550	552500	0,10
20	3190	1595	12350	797500	0,14
30	4900	2450	19000	1225000	0,21
50	8580	4290	33250	2145000	0,35
85	14700	7350	57000	3675000	0,59
100	17400	8700	67450	4350000	0,69

Load / Elongation [%]

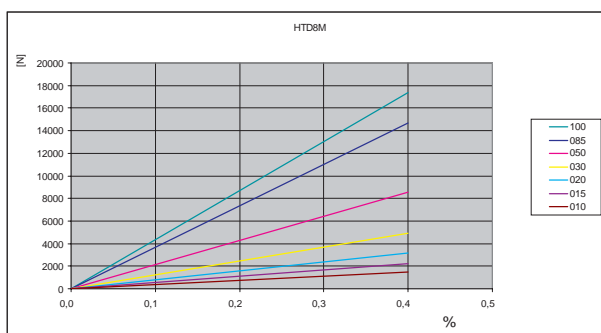

Other widths are available on request.

Tooth shear strength

rpm	F_{Uspez} [N/cm]	rpm	F_{Uspez} [N/cm]	rpm	F_{Uspez} [N/cm]	rpm	F_{Uspez} [N/cm]
0	74,00	800	51,20	1900	39,52	4500	26,63
20	72,62	900	49,71	2000	38,78	5000	25,00
40	71,34	1000	48,35	2200	37,39	5500	23,51
60	70,16	1100	47,09	2400	36,12	6000	22,15
80	69,07	1200	45,93	2600	34,94		
100	68,07	1300	44,84	2800	33,83		
200	64,09	1400	43,82	3000	32,80		
300	61,68	1440	43,43	3200	31,83		
400	59,03	1500	42,86	3400	30,91		
500	56,71	1600	41,96	3600	30,05		
600	54,66	1700	41,10	3800	29,22		
700	52,84	1800	40,29	4000	28,44		

Tooth shear strength / rpm

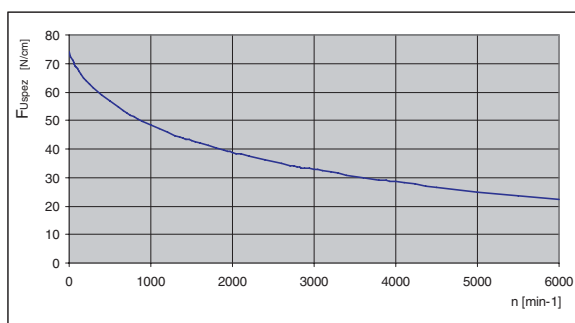

The specific load F_{Uspez} is the maximum load which one single belt tooth 1 cm wide can withstand in all operating conditions. This force is related to the drive rpm. The total load F_U transmissible by the belt in the drive is calculated by:

$$F_U [N] = F_{Uspez} \cdot z_e \cdot b$$

- $F_U [N]$ = peripheral force
- $F_{Uspez} [N/cm]$ = specific load
- z_e = number of teeth in mesh in the small pulley
- z_{emax} = max. no of teeth in mesh to be considered for the calculation of the drive
- $z_{emax} = 12$ for ELATECH® M
- $z_{emax} = 6$ for ELATECH® V
- $b [cm]$ = belt width in cm

Specialties

PROFILE	Belt width b [mm]	ARAMID CORD		STAINLESS STEEL	
		F _{Tzul} [N] M type	F _{Br} [N]	F _{Tzul} [N] M type	F _{Br} [N]
HTD8M	010	1140	4740	1080	4500
	015	1710	7110	1620	6750
	025	3230	13430	3060	12750
	050	6650	27650	6300	26250
	085	11400	47400		
	100	13490	56090		

Flexibility

Minimum pulley number of teeth and minimum idler diameter				
HTD8M		TYPE OF CORD		
		STANDARD	ARAMID	STAINLESS
Drive without reverse bending 	Timing pulley z _{min}	18	18	24
	Idler running on belt teeth d _{min}	50 mm	50 mm	80 mm
Drive with reverse bending 	Timing pulley z _{min}	18	18	24
	Idler running on belt back d _{min}	120 mm	120 mm	100 mm

Timing pulleys

z	da	dw	z	da	dw	z	da	dw	z	da	dw
18	44,46	45,83	47	118,31	119,68	76	192,16	193,53	105	266,01	267,38
19	47,01	48,38	48	120,86	122,23	77	194,71	196,08	106	268,55	269,92
20	49,56	50,93	49	123,40	124,77	78	197,25	198,62	107	271,10	272,47
21	52,10	53,47	50	125,95	127,32	79	199,80	201,17	108	273,64	275,01
22	54,65	56,02	51	128,50	129,87	80	202,35	203,72	109	276,19	277,56
23	57,20	58,57	52	131,05	132,41	81	204,89	206,26	110	278,74	280,11
24	59,75	61,12	53	133,59	134,96	82	207,44	208,81	111	281,29	282,66
25	62,29	63,66	54	136,14	137,51	83	209,98	211,35	112	283,84	285,21
26	64,84	66,21	55	138,68	140,05	84	212,53	213,90	113	286,38	287,75
27	67,38	68,75	56	141,23	142,60	85	215,08	216,45	114	288,93	290,30
28	70,08	71,30	57	143,78	145,15	86	217,63	219,00	115	291,47	292,84
29	72,59	73,84	58	146,32	147,69	87	220,17	221,54	116	294,02	295,39
30	75,13	76,39	59	148,87	150,24	88	222,72	224,09	117	296,57	297,94
31	77,65	78,94	60	151,42	152,79	89	225,26	226,63	118	299,11	300,48
32	80,16	81,49	61	153,96	155,33	90	227,81	229,18	119	301,66	303,03
33	82,68	84,03	62	156,52	157,89	91	230,35	231,72	120	304,20	305,57
34	85,21	86,58	63	159,06	160,43	92	232,90	234,27			
35	87,76	89,12	64	161,60	162,97	93	235,45	236,82			
36	90,30	91,67	65	164,15	165,52	94	238,00	239,37			
37	92,85	94,22	66	166,69	168,06	95	240,54	241,91			
38	95,40	96,77	67	169,24	170,61	96	243,09	244,46			
39	97,94	99,31	68	171,79	173,16	97	245,63	247,00			
40	100,49	101,86	69	174,33	175,70	98	248,18	249,55			
41	103,04	104,40	70	176,88	178,25	99	250,73	252,10			
42	105,58	106,95	71	179,43	180,80	100	253,28	254,67			
43	108,13	109,50	72	181,98	183,35	101	255,82	257,19			
44	110,68	112,05	73	184,52	185,89	102	258,37	259,74			
45	113,22	114,59	74	187,07	188,44	103	260,91	262,28			
46	115,77	117,14	75	189,61	190,98	104	263,46	264,83			

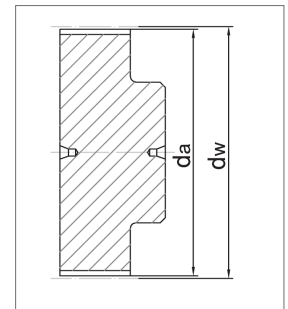

HTD14M

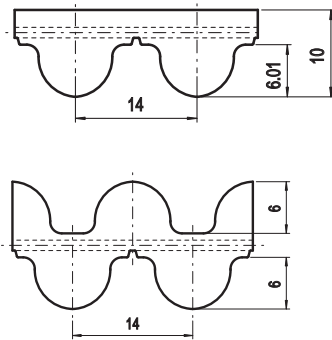

Belt characteristics

- Polyurethane timing belt with round tooth profile and high tensile load tension cords. Produced according to ISO 13050
 - Metric pitch 14 mm
 - The round tooth profile, allows a uniform load distribution that guarantees high performances high transmissible torque and precise tooth engagement.
 - Widely used in linear positioning, heavy power transmission applications
 - Double sided tooth construction available
- Width tolerance: $\pm 1,0$ [mm]
 - Length tolerance: $\pm 0,5$ [mm/m]
 - Thickness tolerance: $\pm 0,4$ [mm]

HTD14M Technical data

Belt width b [mm]	Allowable tensile load Type M F_{Tzul} [N]	Allowable tensile load Type V F_{Tzul} [N]	Breaking load Type M F_{Br} [N]	Specific spring rate C_{spez} [N]	Weight [kg/m]
25	5280	2640	19250	1320000	0,30
40	9120	4560	33250	2280000	0,44
55	12480	6240	45500	3120000	0,61
85	19680	9840	71750	4920000	0,94
115	26880	13440	98000	6720000	1,30
150	35040	17520	127750	8760000	1,68

Load / Elongation [%]

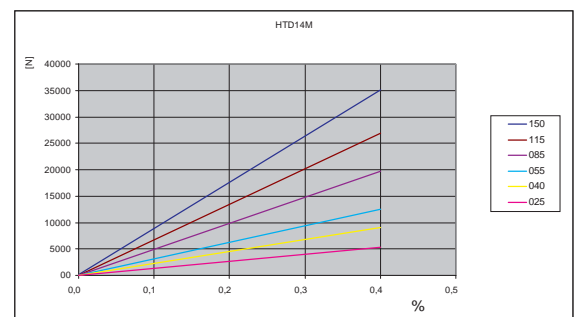

Other widths are available on request.

Tooth shear strength

rpm	F_{Uspez} [N/cm]	rpm	F_{Uspez} [N/cm]	rpm	F_{Uspez} [N/cm]
0	130,00	800	83,80	1900	60,49
20	127,69	900	80,85	2000	59,01
40	125,56	1000	78,14	2200	56,23
60	123,60	1100	75,63	2400	53,68
80	121,78	1200	73,31	2600	51,30
100	120,11	1300	71,14	2800	49,09
200	109,77	1400	69,11	3000	47,01
300	104,29	1440	68,33	3200	45,06
400	99,19	1500	67,19	3400	43,22
500	94,65	1600	65,38	3600	41,48
600	90,64	1700	63,67	3800	39,82
700	87,04	1800	62,04	4000	38,24

Tooth shear strength / rpm

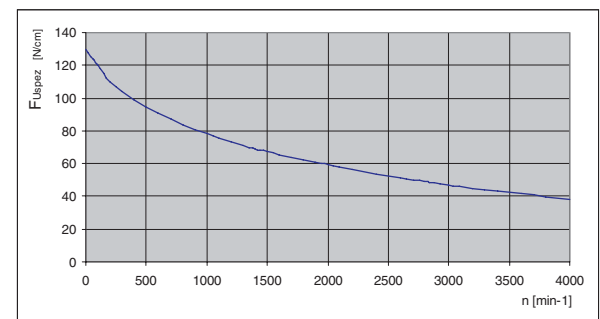

The specific load F_{Uspez} is the maximum load which one single belt tooth 1 cm wide can withstand in all operating conditions. This force is related to the drive rpm. The total load F_U transmissible by the belt in the drive is calculated by:

$$F_U [N] = F_{Uspez} \cdot z_e \cdot b$$

- F_U [N] = peripheral force
- F_{Uspez} [N/cm] = specific load
- z_e = number of teeth in mesh in the small pulley
- z_{emax} = max. no of teeth in mesh to be considered for the calculation of the drive
- $z_{emax} = 12$ for ELATECH® M
- $z_{emax} = 6$ for ELATECH® V
- b [cm] = belt width in cm

Flexibility

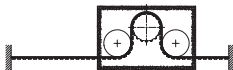
Minimum pulley number of teeth and minimum idler diameter		
HTD14M		TYPE OF CORD
		STANDARD
Drive without reverse bending 	Timing pulley z_{min}	28
	Idler running on belt teeth d_{min}	120 mm
Drive with reverse bending 	Timing pulley z_{min}	28
	Idler running on belt back d_{min}	180 mm

Timing pulleys

z	da	dw	z	da	dw	z	da	dw	z	da	dw
28	122,12	124,77	57	251,22	254,01	86	380,46	383,23	115	509,69	512,47
29	126,58	129,22	58	255,68	258,46	87	384,91	387,70	116	514,14	516,93
30	130,99	133,69	59	260,14	262,91	88	389,37	392,15	117	518,60	521,38
31	135,45	138,14	60	264,60	267,38	89	393,83	396,60	118	523,06	525,83
32	139,88	142,59	61	269,04	271,83	90	398,29	401,07	119	527,51	530,30
33	144,35	147,06	62	273,50	276,28	91	402,73	405,52	120	531,97	534,75
34	148,79	151,51	63	277,96	280,75	92	407,19	409,97			
35	153,25	155,96	64	282,42	285,20	93	411,65	414,44			
36	157,68	160,41	65	286,88	289,65	94	416,10	418,89			
37	162,14	164,88	66	291,32	294,11	95	420,56	423,35			
38	166,60	169,34	67	295,78	298,56	96	425,02	427,80			
39	171,02	173,79	68	300,24	303,03	97	429,48	432,25			
40	175,48	178,24	69	304,70	307,48	98	433,94	436,72			
41	179,92	182,71	70	309,16	311,93	99	438,38	441,17			
42	184,37	187,16	71	313,61	316,40	100	442,84	445,62			
43	188,83	191,61	72	318,07	320,85	101	447,30	450,09			
44	193,29	196,08	73	322,53	325,30	102	451,76	454,54			
45	197,75	200,53	74	326,98	329,77	103	456,21	459,00			
46	202,21	204,98	75	331,44	334,22	104	460,67	463,45			
47	206,65	209,43	76	335,90	338,67	105	465,13	467,90			
48	211,11	213,90	77	340,34	343,12	106	469,58	472,37			
49	215,57	218,35	78	344,80	347,59	107	474,03	476,82			
50	220,03	222,80	79	349,26	352,04	108	478,49	481,28			
51	224,49	227,27	80	353,72	356,49	109	482,95	485,74			
52	228,95	231,72	81	358,17	360,96	110	487,41	490,19			
53	233,39	236,18	82	362,63	365,41	111	491,87	494,64			
54	237,85	240,64	83	367,09	369,86	112	496,32	499,10			
55	242,30	245,09	84	371,54	374,33	113	500,78	503,55			
56	246,76	249,55	85	376,00	378,78	114	505,23	508,02			

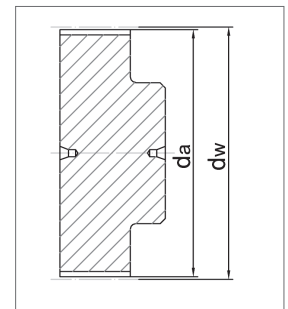

HTD14M XHPL

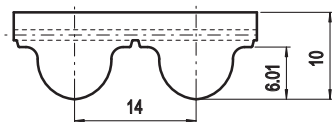

Belt characteristics

- Polyurethane timing belt with round tooth profile and high tensile load tension cords. Produced according to ISO 13050
- Metric pitch 14 mm
- The round tooth profile, allows a uniform load distribution that guarantees high performances high transmissible torque and precise tooth engagement.
- **HTD14M - XHPL is the ideal belt for heavy duty synchronous lifting applications**
- **Black color and PAZ fabric as standard for XHPL execution**
- Width tolerance: $\pm 1,0$ [mm]
- Length tolerance: $\pm 0,5$ [mm/m]
- Thickness tolerance: $\pm 0,5$ [mm]

HTD14M XHPL - Technical data

Belt width b [mm]	Allowable tensile load Type M F_{Tzul} [N]	Breaking load Type M F_{Br} [N]	Specific spring rate C_{spez} [N]	Weight [kg/m]
40	16500	66000	4125000	0,52
55	24000	96000	6000000	0,72
85	36000	144000	9000000	1,11
115	52500	210000	13125000	1,50
150	69000	276000	17250000	2,21

Load / Elongation [%]

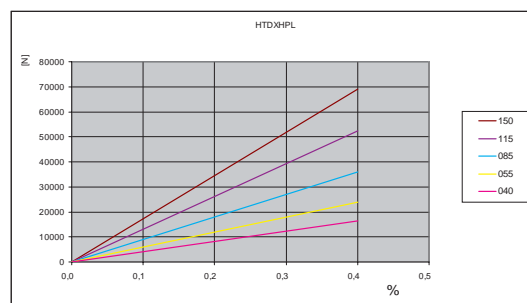

Other widths are available on request.

Tooth shear strength

rpm	F_{Uspez} [N/cm]	rpm	F_{Uspez} [N/cm]	rpm	F_{Uspez} [N/cm]
0	130,00	800	83,80	1900	60,49
20	127,69	900	80,85	2000	59,01
40	125,56	1000	78,14	2200	56,23
60	123,60	1100	75,63	2400	53,68
80	121,78	1200	73,31	2600	51,30
100	120,11	1300	71,14	2800	49,09
200	109,77	1400	69,11	3000	47,01
300	104,29	1440	68,33	3200	45,06
400	99,19	1500	67,19	3400	43,22
500	94,65	1600	65,38	3600	41,48
600	90,64	1700	63,67	3800	39,82
700	87,04	1800	62,04	4000	38,24

Tooth shear strength / rpm

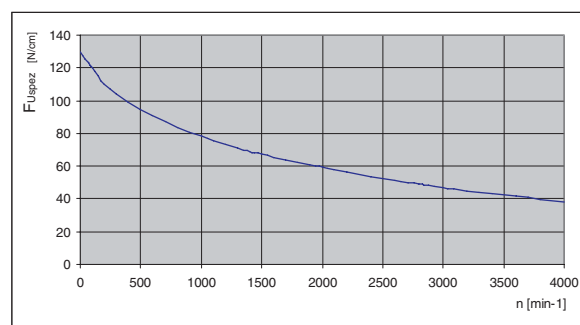

The specific load F_{Uspez} is the maximum load which one single belt tooth 1 cm wide can withstand in all operating conditions. This force is related to the drive rpm.

The total load F_U transmissible by the belt in the drive is calculated by:

$$F_U [N] = F_{Uspez} \cdot Z_e \cdot b$$

- F_U [N] = peripheral force
- F_{Uspez} [N/cm] = specific load
- Z_e = number of teeth in mesh in the small pulley
- Z_{emax} = max. no of teeth in mesh to be considered for the calculation of the drive
- Z_{emax} = 12 for ELATECH® M
- Z_{emax} = 6 for ELATECH® V
- b [cm] = belt width in cm

Flexibility

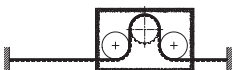
Minimum pulley number of teeth and minimum idler diameter		
HTD14M XHPL		TYPE OF CORD
		STANDARD
 Drive without reverse bending	Timing pulley z_{min}	34
	Idler running on belt teeth d_{min}	140 mm
 Drive with reverse bending	Timing pulley z_{min}	34
	Idler running on belt back d_{min}	200 mm

Timing pulleys

z	da	dw	z	da	dw	z	da	dw	z	da	dw
28	122,12	124,77	57	251,22	254,01	86	380,46	383,23	115	509,69	512,47
29	126,58	129,22	58	255,68	258,46	87	384,91	387,70	116	514,14	516,93
30	130,99	133,69	59	260,14	262,91	88	389,37	392,15	117	518,60	521,38
31	135,45	138,14	60	264,60	267,38	89	393,83	396,60	118	523,06	525,83
32	139,88	142,59	61	269,04	271,83	90	398,29	401,07	119	527,51	530,30
33	144,35	147,06	62	273,50	276,28	91	402,73	405,52	120	531,97	534,75
34	148,79	151,51	63	277,96	280,75	92	407,19	409,97			
35	153,25	155,96	64	282,42	285,20	93	411,65	414,44			
36	157,68	160,41	65	286,88	289,65	94	416,10	418,89			
37	162,14	164,88	66	291,32	294,11	95	420,56	423,35			
38	166,60	169,34	67	295,78	298,56	96	425,02	427,80			
39	171,02	173,79	68	300,24	303,03	97	429,48	432,25			
40	175,48	178,24	69	304,70	307,48	98	433,94	436,72			
41	179,92	182,71	70	309,16	311,93	99	438,38	441,17			
42	184,37	187,16	71	313,61	316,40	100	442,84	445,62			
43	188,83	191,61	72	318,07	320,85	101	447,30	450,09			
44	193,29	196,08	73	322,53	325,30	102	451,76	454,54			
45	197,75	200,53	74	326,98	329,77	103	456,21	459,00			
46	202,21	204,98	75	331,44	334,22	104	460,67	463,45			
47	206,65	209,43	76	335,90	338,67	105	465,13	467,90			
48	211,11	213,90	77	340,34	343,12	106	469,58	472,37			
49	215,57	218,35	78	344,80	347,59	107	474,03	476,82			
50	220,03	222,80	79	349,26	352,04	108	478,49	481,28			
51	224,49	227,27	80	353,72	356,49	109	482,95	485,74			
52	228,95	231,72	81	358,17	360,96	110	487,41	490,19			
53	233,39	236,18	82	362,63	365,41	111	491,87	494,64			
54	237,85	240,64	83	367,09	369,86	112	496,32	499,10			
55	242,30	245,09	84	371,54	374,33	113	500,78	503,55			
56	246,76	249,55	85	376,00	378,78	114	505,23	508,02			

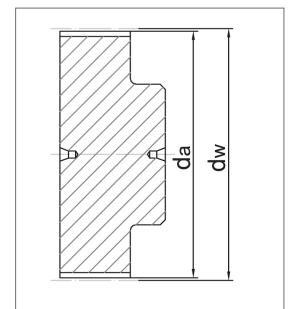

RTD5M

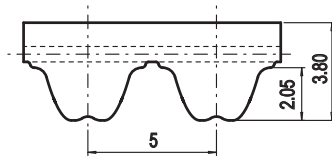

Belt characteristics

- Polyurethane timing belt with round tooth profile and high tensile load tension cords. Produced according to ISO 13050
 - Metric pitch 5 mm
 - The tooth profile allows a uniform load distribution that guarantees high performances, high transmissible torque and precise tooth engagement
 - PAZ fabric on tooth side delivered as standard reduces noise in the drive
 - Widely used in linear positioning, light power transmission applications
- Width tolerance: $\pm 0,5$ [mm]
 - Length tolerance: $\pm 0,5$ [mm/m]
 - Thickness tolerance: $\pm 0,2$ [mm]

Technical data

Belt width b [mm]	Allowable tensile load Type M F_{Tzul} [N]	Allowable tensile load Type V F_{Tzul} [N]	Breaking load Type M F_{Br} [N]	Specific spring rate C_{spez} [N]	Weight [kg/m]
10	920	460	3360	230000	0,05
15	1500	750	5460	375000	0,07
25	2650	1325	9660	662500	0,12
30	3220	1610	11760	805000	0,15
50	5520	2760	20160	1380000	0,25
100	11270	5635	41160	2817500	0,48

Load / Elongation [%]

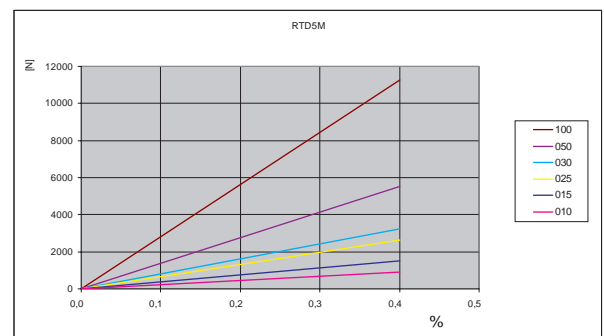

Other widths are available on request.

Tooth shear strength

rpm	F_{Uspez} [N/cm]	rpm	F_{Uspez} [N/cm]	rpm	F_{Uspez} [N/cm]	rpm	F_{Uspez} [N/cm]
0	37,80	900	28,61	2200	23,30	5500	16,95
20	37,25	1000	28,05	2400	22,72	6000	16,32
40	36,75	1100	27,52	2600	22,19	6500	15,74
60	36,30	1200	27,03	2800	21,69	7000	15,19
80	35,89	1300	26,56	2880	21,50	7500	14,68
100	35,52	1400	26,13	3000	21,23	8000	14,20
200	34,13	1440	25,96	3200	20,78	8500	13,75
300	32,87	1500	25,71	3400	20,37	9000	13,33
400	32,10	1600	25,32	3600	19,97	9500	12,92
500	31,31	1700	24,94	3800	19,59	10000	12,53
600	30,56	1800	24,58	4000	19,23		
700	29,86	1900	24,24	4500	18,40		
800	29,21	2000	23,91	5000	17,64		

Tooth shear strength / rpm

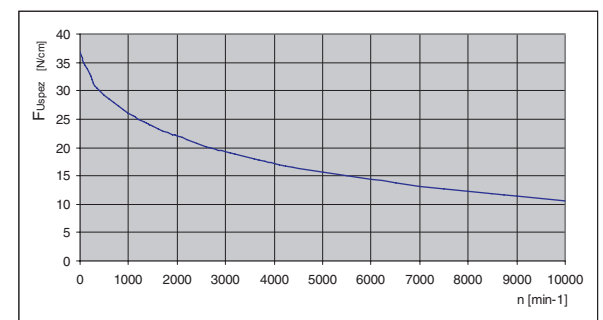

The specific load F_{Uspez} is the maximum load which one single belt tooth 1 cm wide can withstand in all operating conditions. This force is related to the drive rpm. The total load F_U transmissible by the belt in the drive is calculated by:

$$F_U [N] = F_{Uspez} \cdot Z_e \cdot b$$

- F_U [N] = peripheral force
- F_{Uspez} [N/cm] = specific load
- Z_e = number of teeth in mesh in the small pulley
- Z_{emax} = max. no of teeth in mesh to be considered for the calculation of the drive
- $Z_{emax} = 12$ for ELATECH® M
- $Z_{emax} = 6$ for ELATECH® V
- b [cm] = belt width in cm

Specialties

PROFILE	Belt width b [mm]	ARAMID CORD		STAINLESS STEEL		HFE High flexibility	
		F _{Tzul} [N] M type	F _{Br} [N]	F _{Tzul} [N] M type	F _{Br} [N]	F _{Tzul} [N] M type	F _{Br} [N]
RTD5M	010	880	3600	600	2400	960	3440
	015	1430	5850	980	3900	1560	5590
	025	2530	10350	1730	6900	2760	9890
	030	3080	12600	2100	8400	3360	12040
	050	5280	21600	3600	14400	5760	20640
	100	10780	44100			11760	42140

Flexibility

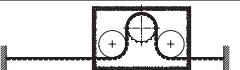
Minimum pulley number of teeth and minimum idler diameter					
RTD5M		TYPE OF CORD			
		STANDARD	ARAMID	STAINLESS	HFE
Drive without reverse bending 	Timing pulley z _{min}	12	12	15	12
	Idler running on belt teeth d _{min}	50 mm	50 mm	60 mm	40 mm
Drive with reverse bending 	Timing pulley z _{min}	15	15	16	15
	Idler running on belt back d _{min}	50 mm	60 mm	60 mm	40 mm

Timing pulleys

z	da	dw	z	da	dw	z	da	dw	z	da	dw
10	14,77	15,91	39	60,93	62,07	68	107,08	108,22	97	153,24	154,38
11	16,36	17,50	40	62,52	63,66	69	108,67	109,81	98	154,83	155,97
12	17,96	19,10	41	64,11	65,25	70	110,27	111,41	99	156,42	157,56
13	19,55	20,69	42	65,70	66,84	71	111,86	113,00	100	158,01	159,15
14	21,14	22,28	43	67,29	68,43	72	113,45	114,59	101	159,61	160,75
15	22,73	23,87	44	68,88	70,02	73	115,04	116,18	102	161,20	162,34
16	24,32	25,46	45	70,47	71,61	74	116,63	117,77	103	162,81	163,95
17	25,91	27,05	46	72,06	73,20	75	118,22	119,36	104	164,38	165,52
18	27,51	28,65	47	73,65	74,79	76	119,81	120,95	105	165,97	167,11
19	29,09	30,23	48	75,24	76,38	77	121,40	122,54	106	167,56	168,70
20	30,69	31,83	49	76,84	77,98	78	122,99	124,13	107	169,09	170,23
21	32,28	33,42	50	78,44	79,58	79	124,58	125,72	108	170,75	171,89
22	33,87	35,01	51	80,03	81,17	80	126,18	127,32	109	172,34	173,48
23	35,46	36,60	52	81,62	82,76	81	127,77	128,91	110	173,93	175,07
24	37,06	38,20	53	83,21	84,35	82	129,36	130,50	111	175,52	176,66
25	38,64	39,78	54	84,80	85,94	83	130,95	132,09	112	177,11	178,25
26	40,24	41,38	55	86,39	87,53	84	132,54	133,68	113	178,70	179,84
27	41,83	42,97	56	87,98	89,12	85	134,14	135,28	114	180,29	181,43
28	43,42	44,56	57	89,57	90,71	86	135,73	136,87	115	181,88	183,02
29	45,01	46,15	58	91,17	92,31	87	137,32	138,46	116	183,47	184,61
30	46,61	47,75	59	92,76	93,90	88	138,91	140,05	117	185,07	186,21
31	48,19	49,33	60	94,35	95,49	89	140,51	141,65	118	186,66	187,80
32	49,79	50,93	61	95,94	97,08	90	142,10	143,24	119	188,25	189,39
33	51,38	52,52	62	97,53	98,67	91	143,69	144,83	120	189,84	190,98
34	52,97	54,11	63	99,12	100,26	92	145,28	146,42			
35	54,56	55,70	64	100,72	101,86	93	146,87	148,01			
36	56,16	57,30	65	102,31	103,45	94	148,46	149,60			
37	57,75	58,89	66	103,90	105,04	95	150,06	151,20			
38	59,34	60,48	67	105,49	106,63	96	151,64	152,78			

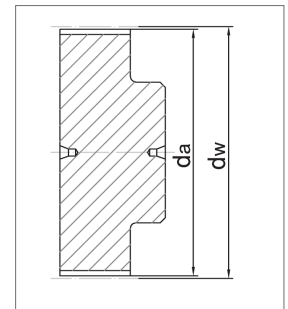

RTD8M

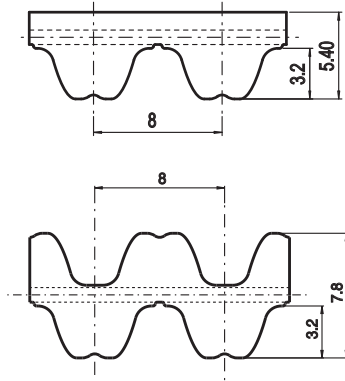

Belt characteristics

- Polyurethane timing belt with round tooth profile and high tensile load tension cords. Produced according to ISO 13050
 - Metric pitch 8 mm
 - The tooth profile allows a uniform load distribution that guarantees high performances, high transmissible torque and precise tooth engagement.
 - PAZ fabric on tooth side delivered as standard reduces noise in the drive
 - Widely used in linear positioning, medium power transmission applications
- Width tolerance: $\pm 0,5$ [mm]
 - Length tolerance: $\pm 0,5$ [mm/m]
 - Thickness tolerance: $\pm 0,2$ [mm]

Technical data

Belt width b [mm]	Allowable tensile load Type M F_{Tzul} [N]	Allowable tensile load Type V F_{Tzul} [N]	Breaking load Type M F_{Br} [N]	Specific spring rate C_{spez} [N]	Weight [kg/m]
10	1470	735	5700	367500	0,07
15	2210	1105	8550	552500	0,10
20	3190	1595	12350	797500	0,14
30	4900	2450	19000	1225000	0,20
50	8580	4290	33250	2145000	0,35
85	14700	7350	57000	3675000	0,60
100	17400	8700	67450	4350000	0,75

Other widths are available on request.

Tooth shear strength

rpm	F_{Uspez} [N/cm]	rpm	F_{Uspez} [N/cm]	rpm	F_{Uspez} [N/cm]	rpm	F_{Uspez} [N/cm]
0	76,00	800	53,20	1900	41,52	4000	30,44
20	74,62	900	51,71	2000	40,78	4500	28,63
40	73,34	1000	50,35	2200	39,39	5000	27,00
60	72,16	1100	49,09	2400	38,12	5500	25,51
80	71,07	1200	47,93	2600	36,94	6000	24,15
100	70,07	1300	46,84	2800	35,83		
200	66,09	1400	45,82	2880	35,41		
300	63,68	1440	45,43	3000	34,80		
400	61,03	1500	44,86	3200	33,83		
500	58,71	1600	43,96	3400	32,91		
600	56,66	1700	43,10	3600	32,05		
700	54,84	1800	42,29	3800	31,22		

The specific load F_{Uspez} is the maximum load which one single belt tooth 1 cm wide can withstand in all operating conditions. This force is related to the drive rpm. The total load F_U transmissible by the belt in the drive is calculated by:

$$F_U [N] = F_{Uspez} \cdot z_e \cdot b$$

Load / Elongation [%]

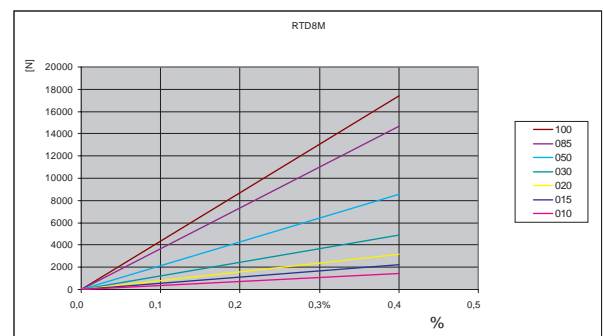

Tooth shear strength / rpm

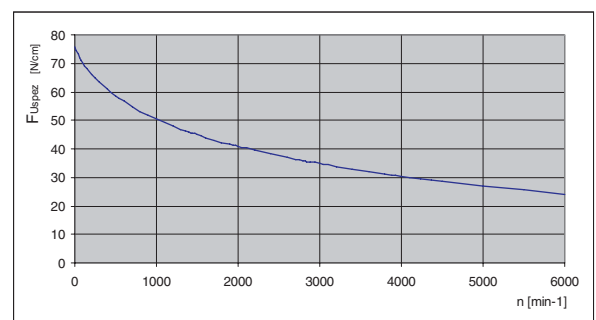

- F_U [N] = peripheral force
- F_{Uspez} [N/cm] = specific load
- z_e = number of teeth in mesh in the small pulley
- z_{emax} = max. no of teeth in mesh to be considered for the calculation of the drive
- z_{emax} = 12 for ELATECH® M
- z_{emax} = 6 for ELATECH® V
- b [cm] = belt width in cm

Specialties

PROFILE	Belt width b [mm]	ARAMID CORD		STAINLESS STEEL	
		F _{Tzul} [N] M type	F _{Br} [N]	F _{Tzul} [N] M type	F _{Br} [N]
RTD8M	010	1140	4740	1080	4500
	015	1710	7110	1620	6750
	025	3230	13430	3060	12750
	050	6650	27650	6300	26250
	085	11400	47400		
	100	13490	56090		

Flexibility

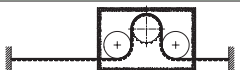
Minimum pulley number of teeth and minimum idler diameter				
RTD8M		TYPE OF CORD		
		STANDARD	ARAMID	STAINLESS
Drive without reverse bending 	Timing pulley z _{min}	18	18	20
	Idler running on belt teeth d _{min}	50 mm	50 mm	50 mm
Drive with reverse bending 	Timing pulley z _{min}	18	18	20
	Idler running on belt back d _{min}	120 mm	120 mm	120 mm

Timing pulleys

z	da	dw	z	da	dw	z	da	dw	z	da	dw
18	44,46	45,83	47	118,31	119,68	76	192,16	193,53	105	266,01	267,38
19	47,01	48,38	48	120,86	122,23	77	194,71	196,08	106	268,55	269,92
20	49,56	50,93	49	123,40	124,77	78	197,25	198,62	107	271,10	272,47
21	52,10	53,47	50	125,95	127,32	79	199,80	201,17	108	273,64	275,01
22	54,65	56,02	51	128,50	129,87	80	202,35	203,72	109	276,19	277,56
23	57,20	58,57	52	131,05	132,41	81	204,89	206,26	110	278,74	280,11
24	59,75	61,12	53	133,59	134,96	82	207,44	208,81	111	281,29	282,66
25	62,29	63,66	54	136,14	137,51	83	209,98	211,35	112	283,84	285,21
26	64,84	66,21	55	138,68	140,05	84	212,53	213,90	113	286,38	287,75
27	67,38	68,75	56	141,23	142,60	85	215,08	216,45	114	288,93	290,30
28	70,08	71,30	57	143,78	145,15	86	217,63	219,00	115	291,47	292,84
29	72,59	73,84	58	146,32	147,69	87	220,17	221,54	116	294,02	295,39
30	75,13	76,39	59	148,87	150,24	88	222,72	224,09	117	296,57	297,94
31	77,65	78,94	60	151,42	152,79	89	225,26	226,63	118	299,11	300,48
32	80,16	81,49	61	153,96	155,33	90	227,81	229,18	119	301,66	303,03
33	82,68	84,03	62	156,52	157,89	91	230,35	231,72	120	304,20	305,57
34	85,21	86,58	63	159,06	160,43	92	232,90	234,27			
35	87,76	89,12	64	161,60	162,97	93	235,45	236,82			
36	90,30	91,67	65	164,15	165,52	94	238,00	239,37			
37	92,85	94,22	66	166,69	168,06	95	240,54	241,91			
38	95,40	96,77	67	169,24	170,61	96	243,09	244,46			
39	97,94	99,31	68	171,79	173,16	97	245,63	247,00			
40	100,49	101,86	69	174,33	175,70	98	248,18	249,55			
41	103,04	104,40	70	176,88	178,25	99	250,73	252,10			
42	105,58	106,95	71	179,43	180,80	100	253,28	254,67			
43	108,13	109,50	72	181,98	183,35	101	255,82	257,19			
44	110,68	112,05	73	184,52	185,89	102	258,37	259,74			
45	113,22	114,59	74	187,07	188,44	103	260,91	262,28			
46	115,77	117,14	75	189,61	190,98	104	263,46	264,83			

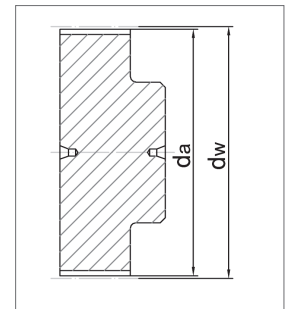

RTD14M

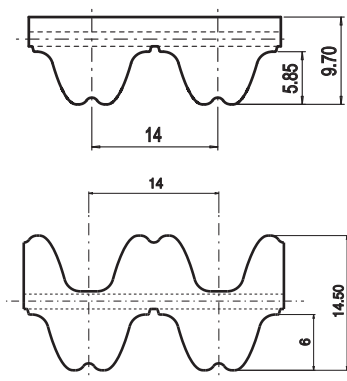

Belt characteristics

- Polyurethane timing belt with round tooth profile and high tensile load tension cords. Produced according to ISO 13050
 - Metric pitch 14 mm
 - The tooth profile, allows a uniform load distribution that guarantees high performances high transmissible torque and precise tooth engagement
 - PAZ fabric on tooth side delivered as standard reduces noise in the drive
 - Widely used in linear positioning, heavy power transmission applications
- Width tolerance: $\pm 1,0$ [mm]
 - Length tolerance: $\pm 0,5$ [mm/m]
 - Thickness tolerance: $\pm 0,4$ [mm]

RTD14M Technical data

Belt width b [mm]	Allowable tensile load Type M F_{Tzul} [N]	Allowable tensile load Type V F_{Tzul} [N]	Breaking load Type M F_{Br} [N]	Specific spring rate C_{spez} [N]	Weight [kg/m]
40	12750	6375	48000	3187500	0,48
55	17850	8925	67200	4462500	0,68
85	28050	14025	105600	7012500	1,00
115	38250	19125	144000	9562500	1,40

Other widths are available on request.

Load / Elongation [%]

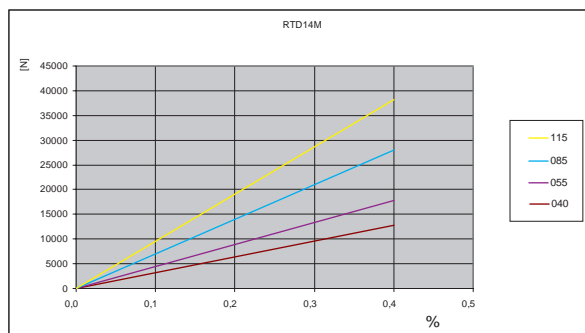

Tooth shear strength

rpm	F_{Uspez} [N/cm]	rpm	F_{Uspez} [N/cm]	rpm	F_{Uspez} [N/cm]
0	140,00	900	90,85	2200	66,23
20	137,31	1000	88,14	2400	63,68
40	134,83	1100	85,63	2600	61,30
60	132,53	1200	83,31	2800	59,09
80	130,42	1300	81,14	2880	58,24
100	128,46	1400	79,11	3000	57,01
200	119,77	1440	78,33	3200	55,06
300	114,29	1500	77,19	3400	53,22
400	109,19	1600	75,38	3600	51,48
500	104,65	1700	73,67	3800	49,82
600	100,64	1800	72,04	4000	48,24
700	97,04	1900	70,49		
800	93,80	2000	69,01		

Tooth shear strength / rpm

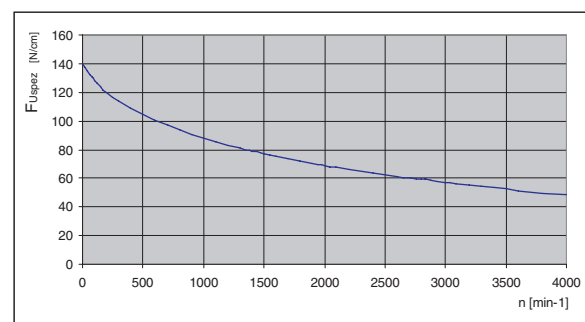

The specific load F_{Uspez} is the maximum load which one single belt tooth 1 cm wide can withstand in all operating conditions. This force is related to the drive rpm. The total load F_U transmissible by the belt in the drive is calculated by:

$$F_U [N] = F_{Uspez} \cdot z_e \cdot b$$

- F_U [N] = peripheral force
- F_{Uspez} [N/cm] = specific load
- z_e = number of teeth in mesh in the small pulley
- z_{emax} = max. no of teeth in mesh to be considered for the calculation of the drive
- $z_{emax} = 12$ for ELATECH® M
- $z_{emax} = 6$ for ELATECH® V
- b [cm] = belt width in cm

Flexibility
Minimum pulley number of teeth and minimum idler diameter

RTD14M		TYPE OF CORD STANDARD
Drive without reverse bending	Timing pulley z_{min}	32

Timing pulleys

z	da	dw
28	122,12	124,77
29	126,58	129,22
30	130,99	133,69
31	135,45	138,14
32	139,88	142,59
33	144,35	147,06
34	148,79	151,51
35	153,25	155,96
36	157,68	160,41
37	162,14	164,88
38	166,60	169,34
39	171,02	173,79
40	175,48	178,24
41	179,92	182,71
42	184,37	187,16
43	188,83	191,61
44	193,29	196,08
45	197,75	200,53
46	202,21	204,98
47	206,65	209,43
48	211,11	213,90
49	215,57	218,35
50	220,03	222,80
51	224,49	227,27
52	228,95	231,72
53	233,39	236,18
54	237,85	240,64
55	242,30	245,09
56	246,76	249,55

z	da	dw
57	251,22	254,01
58	255,68	258,46
59	260,14	262,91
60	264,60	267,38
61	269,04	271,83
62	273,50	276,28
63	277,96	280,75
64	282,42	285,20
65	286,88	289,65
66	291,32	294,11
67	295,78	298,56
68	300,24	303,03
69	304,70	307,48
70	309,16	311,93
71	313,61	316,40
72	318,07	320,85
73	322,53	325,30
74	326,98	329,77
75	331,44	334,22
76	335,90	338,67
77	340,34	343,12
78	344,80	347,59
79	349,26	352,04
80	353,72	356,49
81	358,17	360,96
82	362,63	365,41
83	367,09	369,86
84	371,54	374,33
85	376,00	378,78

z	da	dw
86	380,46	383,23
87	384,91	387,70
88	389,37	392,15
89	393,83	396,60
90	398,29	401,07
91	402,73	405,52
92	407,19	409,97
93	411,65	414,44
94	416,10	418,89
95	420,56	423,35
96	425,02	427,80
97	429,48	432,25
98	433,94	436,72
99	438,38	441,17
100	442,84	445,62
101	447,30	450,09
102	451,76	454,54
103	456,21	459,00
104	460,67	463,45
105	465,13	467,90
106	469,58	472,37
107	474,03	476,82
108	478,49	481,28
109	482,95	485,74
110	487,41	490,19
111	491,87	494,64
112	496,32	499,10
113	500,78	503,55
114	505,23	508,02

z	da	dw
115	509,69	512,47
116	514,14	516,93
117	518,60	521,38
118	523,06	525,83
119	527,51	530,30
120	531,97	534,75

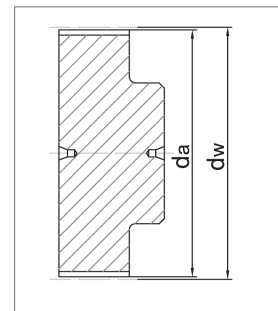

RTD14M HPL

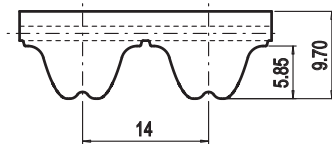

Belt characteristics

- Polyurethane timing belt with round tooth profile and high tensile load tension cords. Produced according to ISO 13050
- Metric pitch 14 mm
- The tooth profile, allows a uniform load distribution that guarantees high performances high transmissible torque and precise tooth engagement
- PAZ fabric on tooth side delivered as standard reduces noise in the drive
- **RTD14M - HPL is the ideal belt for heavy duty synchronous lifting applications. Black colour as standard.**

- Width tolerance: $\pm 1,0$ [mm]
- Length tolerance: $\pm 0,5$ [mm/m]
- Thickness tolerance: $\pm 0,4$ [mm]

RTD14M HPL - Technical data

Belt width b [mm]	Allowable tensile load Type M F_{Tzul} [N]	Breaking load Type M F_{Br} [N]	Specific spring rate C_{spez} [N]	Weight [kg/m]
40	14950	59800	3737500	0,52
55	20700	82800	5175000	0,72
75	28750	115000	7187500	1,11
85	32200	128800	8050000	1,30
100	36800	147200	9200000	1,45
115	42550	170200	10637500	1,60
150	57500	230000	14375000	2,20

Other widths are available on request.

Load / Elongation [%]

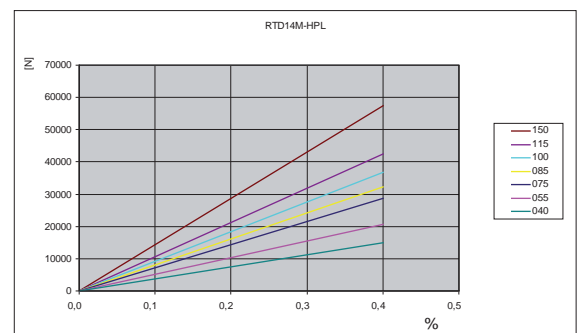

Tooth shear strength

rpm	F_{Uspez} [N/cm]	rpm	F_{Uspez} [N/cm]	rpm	F_{Uspez} [N/cm]
0	140,00	900	90,85	2200	66,23
20	137,31	1000	88,14	2400	63,68
40	134,83	1100	85,63	2600	61,30
60	132,53	1200	83,31	2800	59,09
80	130,42	1300	81,14	2880	58,24
100	128,46	1400	79,11	3000	57,01
200	119,77	1440	78,33	3200	55,06
300	114,29	1500	77,19	3400	53,22
400	109,19	1600	75,38	3600	51,48
500	104,65	1700	73,67	3800	49,82
600	100,64	1800	72,04	4000	48,24
700	97,04	1900	70,49		
800	93,80	2000	69,01		

Tooth shear strength / rpm

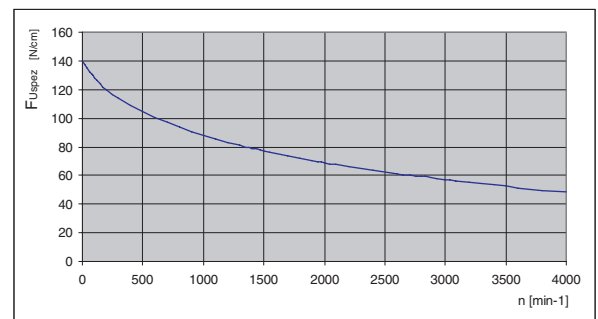

The specific load F_{Uspez} is the maximum load which one single belt tooth 1 cm wide can withstand in all operating conditions. This force is related to the drive rpm. The total load F_U transmissible by the belt in the drive is calculated by:

$$F_U [N] = F_{Uspez} \cdot z_e \cdot b$$

- F_U [N] = peripheral force
- F_{Uspez} [N/cm] = specific load
- z_e = number of teeth in mesh in the small pulley
- z_{emax} = max. no of teeth in mesh to be considered for the calculation of the drive
- $z_{emax} = 12$ for ELATECH® M
- $z_{emax} = 6$ for ELATECH® V
- b [cm] = belt width in cm

Flexibility

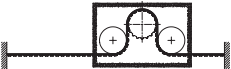
Minimum pulley number of teeth and minimum idler diameter		
RTD14M HPL		TYPE OF CORD
		STANDARD
Drive without reverse bending 	Timing pulley z_{min}	34
	Idler running on belt teeth d_{min}	150 mm
Drive with reverse bending 	Timing pulley z_{min}	34
	Idler running on belt back d_{min}	250 mm

Timing pulleys

z	da	dw	z	da	dw	z	da	dw	z	da	dw
28	122,12	124,77	57	251,22	254,01	86	380,46	383,23	115	509,69	512,47
29	126,58	129,22	58	255,68	258,46	87	384,91	387,70	116	514,14	516,93
30	130,99	133,69	59	260,14	262,91	88	389,37	392,15	117	518,60	521,38
31	135,45	138,14	60	264,60	267,38	89	393,83	396,60	118	523,06	525,83
32	139,88	142,59	61	269,04	271,83	90	398,29	401,07	119	527,51	530,30
33	144,35	147,06	62	273,50	276,28	91	402,73	405,52	120	531,97	534,75
34	148,79	151,51	63	277,96	280,75	92	407,19	409,97			
35	153,25	155,96	64	282,42	285,20	93	411,65	414,44			
36	157,68	160,41	65	286,88	289,65	94	416,10	418,89			
37	162,14	164,88	66	291,32	294,11	95	420,56	423,35			
38	166,60	169,34	67	295,78	298,56	96	425,02	427,80			
39	171,02	173,79	68	300,24	303,03	97	429,48	432,25			
40	175,48	178,24	69	304,70	307,48	98	433,94	436,72			
41	179,92	182,71	70	309,16	311,93	99	438,38	441,17			
42	184,37	187,16	71	313,61	316,40	100	442,84	445,62			
43	188,83	191,61	72	318,07	320,85	101	447,30	450,09			
44	193,29	196,08	73	322,53	325,30	102	451,76	454,54			
45	197,75	200,53	74	326,98	329,77	103	456,21	459,00			
46	202,21	204,98	75	331,44	334,22	104	460,67	463,45			
47	206,65	209,43	76	335,90	338,67	105	465,13	467,90			
48	211,11	213,90	77	340,34	343,12	106	469,58	472,37			
49	215,57	218,35	78	344,80	347,59	107	474,03	476,82			
50	220,03	222,80	79	349,26	352,04	108	478,49	481,28			
51	224,49	227,27	80	353,72	356,49	109	482,95	485,74			
52	228,95	231,72	81	358,17	360,96	110	487,41	490,19			
53	233,39	236,18	82	362,63	365,41	111	491,87	494,64			
54	237,85	240,64	83	367,09	369,86	112	496,32	499,10			
55	242,30	245,09	84	371,54	374,33	113	500,78	503,55			
56	246,76	249,55	85	376,00	378,78	114	505,23	508,02			

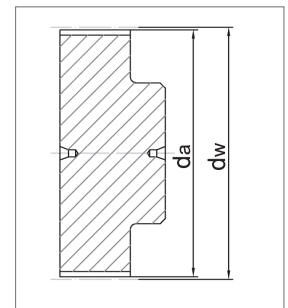

STD5M

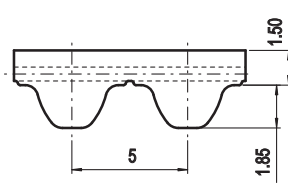

Belt characteristics

- Polyurethane timing belt with evolvent tooth, high tensile load steel cords and high torque capacity. Produced according to ISO 13050
 - Metric pitch 5 mm
 - Low noise generation in high speed drives
 - Offers excellent operational reliability in linear positioning and light power transmission applications
 - The special profile allows smooth running properties
- Width tolerance: $\pm 0,5$ [mm]
 - Length tolerance: $\pm 0,5$ [mm/m]
 - Thickness tolerance: $\pm 0,2$ [mm]

Technical data

Belt width b [mm]	Allowable tensile load Type M F_{Tzul} [N]	Allowable tensile load Type V F_{Tzul} [N]	Breaking load Type M F_{Br} [N]	Specific spring rate Cspez [N]	Weight [kg/m]
10	920	460	3360	230000	0,05
15	1500	750	5460	375000	0,07
25	2650	1325	9660	662500	0,12
50	5520	2760	20160	1380000	0,23
100	11270	5635	41160	2817500	0,46

Load / Elongation [%]

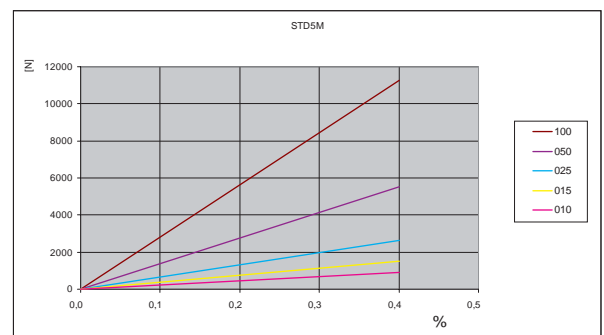

Other widths are available on request.

Tooth shear strength

rpm	F_{Uspez} [N/cm]	rpm	F_{Uspez} [N/cm]	rpm	F_{Uspez} [N/cm]	rpm	F_{Uspez} [N/cm]
0	36,90	800	27,71	1900	22,74	4500	16,90
20	36,35	900	27,11	2000	22,41	5000	16,14
40	35,85	1000	26,55	2200	21,80	5500	15,45
60	35,40	1100	26,02	2400	21,22	6000	14,82
80	34,99	1200	25,53	2600	20,69	6500	14,24
100	34,62	1300	25,06	2800	20,19	7000	13,69
200	33,23	1400	24,63	3000	19,73	7500	13,18
300	31,37	1440	24,46	3200	19,28	8000	12,70
400	30,60	1500	24,21	3400	18,87	8500	12,25
500	29,81	1600	23,82	3600	18,47	9000	11,83
600	29,06	1700	23,44	3800	18,09	9500	11,42
700	28,36	1800	23,08	4000	17,73	10000	11,03

Tooth shear strength / rpm

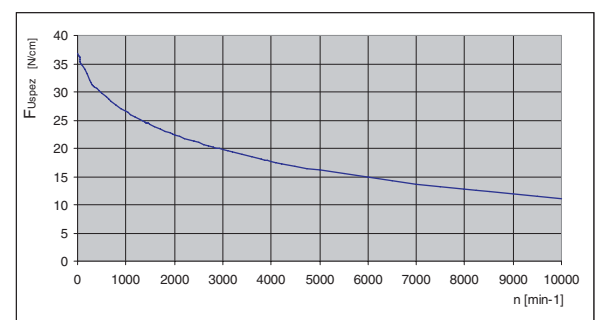

The specific load F_{Uspez} is the maximum load which one single belt tooth 1 cm wide can withstand in all operating conditions. This force is related to the drive rpm. The total load F_U transmissible by the belt in the drive is calculated by:

$$F_U [N] = F_{Uspez} \cdot z_e \cdot b$$

- F_U [N] = peripheral force
- F_{Uspez} [N/cm] = specific load
- z_e = number of teeth in mesh in the small pulley
- z_{emax} = max. no of teeth in mesh to be considered for the calculation of the drive
- $z_{emax} = 12$ for ELATECH® M
- $z_{emax} = 6$ for ELATECH® V
- b [cm] = belt width in cm

Specialties

PROFILE	Belt width b [mm]	ARAMID CORD		STAINLESS STEEL		HFE High flexibility	
		F _{Tzul} [N] M type	F _{Br} [N]	F _{Tzul} [N] M type	F _{Br} [N]	F _{Tzul} [N] M type	F _{Br} [N]
STD5M	010	880	3600	600	2400	960	3440
	015	1430	5850	980	3900	1560	5590
	025	2530	10350	1730	6900	2760	9890
	050	5280	21600	3600	14400	5760	20640
	100	10780	44100			11760	42140

Flexibility

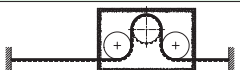
Minimum pulley number of teeth and minimum idler diameter					
STD5M		TYPE OF CORD			
		STANDARD	ARAMID	STAINLESS	HFE
Drive without reverse bending 	Timing pulley z _{min}	16	16	18	16
	Idler running on belt teeth d _{min}	50 mm	50 mm	60 mm	40 mm
Drive with reverse bending 	Timing pulley z _{min}	20	20	20	20
	Idler running on belt back d _{min}	50 mm	50 mm	60 mm	40 mm

Timing pulleys

z	da	dw	z	da	dw	z	da	dw	z	da	dw
10	14,95	15,91	39	61,11	62,07	68	107,27	108,23	97	153,42	154,38
11	16,54	17,50	40	62,70	63,66	69	108,86	109,82	98	155,01	155,97
12	18,14	19,10	41	64,30	65,26	70	110,45	111,41	99	156,60	157,56
13	19,73	20,69	42	65,89	66,85	71	112,04	113,00	100	158,19	159,15
14	21,32	22,28	43	67,48	68,44	72	113,63	114,59	101	159,79	160,75
15	22,91	23,87	44	69,07	70,03	73	115,23	116,19	102	161,38	162,34
16	24,51	25,47	45	70,66	71,62	74	116,82	117,78	103	162,99	163,95
17	26,10	27,06	46	72,25	73,21	75	118,41	119,37	104	164,56	165,52
18	27,69	28,65	47	73,84	74,80	76	120,00	120,96	105	166,15	167,11
19	29,27	30,23	48	75,43	76,39	77	121,59	122,55	106	167,74	168,70
20	30,87	31,83	49	77,03	77,99	78	123,18	124,14	107	169,34	170,30
21	32,46	33,42	50	78,62	79,58	79	124,77	125,73	108	170,93	171,89
22	34,05	35,01	51	80,21	81,17	80	126,36	127,32	109	172,52	173,48
23	35,65	36,61	52	81,80	82,76	81	127,95	128,91	110	174,10	175,06
24	37,23	38,19	53	83,39	84,35	82	129,54	130,50	111	175,70	176,66
25	38,83	39,79	54	84,99	85,95	83	131,14	132,10	112	177,29	178,25
26	40,42	41,38	55	86,58	87,54	84	132,73	133,69	113	178,88	179,84
27	42,01	42,97	56	88,17	89,13	85	134,32	135,28	114	180,47	181,43
28	43,60	44,56	57	89,76	90,72	86	135,91	136,87	115	182,06	183,02
29	45,19	46,15	58	91,35	92,31	87	137,51	138,47	116	183,65	184,61
30	46,79	47,75	59	92,94	93,90	88	139,09	140,05	117	185,25	186,21
31	48,38	49,34	60	94,53	95,49	89	140,69	141,65	118	186,84	187,80
32	49,97	50,93	61	96,13	97,09	90	142,28	143,24	119	188,43	189,39
33	51,56	52,52	62	97,72	98,68	91	143,87	144,83	120	190,02	190,98
34	53,15	54,11	63	99,31	100,27	92	145,46	146,42			
35	54,75	55,71	64	100,90	101,86	93	147,05	148,01			
36	56,34	57,30	65	102,49	103,45	94	148,64	149,60			
37	57,93	58,89	66	104,08	105,04	95	150,24	151,20			
38	59,52	60,48	67	105,67	106,63	96	151,83	152,71			

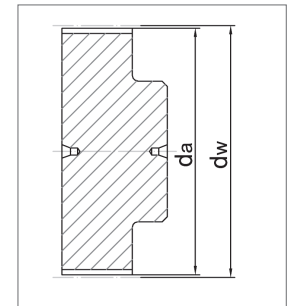

STD8M

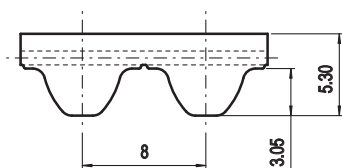

Belt characteristics

- Polyurethane timing belt with involute tooth, high tensile load steel cords and high torque capacity. Produced according to ISO 13050
 - Metric pitch 8 mm
 - Low noise generation in high speed drives
 - Offers excellent operational reliability in linear positioning and medium power transmission applications
 - Widely used in automatic doors
 - The special profile allows smooth running properties
- Width tolerance: $\pm 0,5$ [mm]
 - Length tolerance: $\pm 0,5$ [mm/m]
 - Thickness tolerance: $\pm 0,2$ [mm]

Technical data

Belt width b [mm]	Allowable tensile load Type M F_{Tzul} [N]	Allowable tensile load Type V F_{Tzul} [N]	Breaking load Type M F_{Br} [N]	Specific spring rate C_{spez} [N]	Weight [kg/m]
10	1470	735	5700	367500	0,07
15	2210	1105	8550	552500	0,10
20	3190	1595	12350	797500	0,13
30	4660	2330	18050	1165000	0,20
50	8580	4290	33250	2145000	0,33
85	14700	7350	57000	3675000	0,56
100	17400	8700	67450	4350000	0,66

Load / Elongation [%]

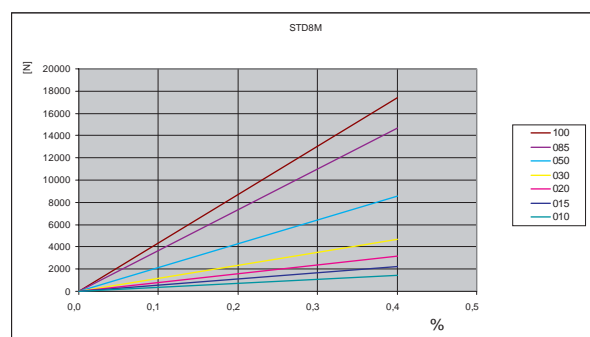

Other widths are available on request.

Tooth shear strength

rpm	F_{Uspez} [N/cm]	rpm	F_{Uspez} [N/cm]	rpm	F_{Uspez} [N/cm]	rpm	F_{Uspez} [N/cm]
0	74,10	800	51,53	1900	39,76	4500	26,79
20	73,05	900	50,03	2000	39,02	5000	25,14
40	72,06	1000	48,66	2200	37,62	5500	23,65
60	71,13	1100	47,39	2400	36,34	6000	22,28
80	70,26	1200	46,22	2600	35,15		
100	69,43	1300	45,12	2800	34,04		
200	65,98	1400	44,10	3000	33,00		
300	62,11	1440	43,70	3200	32,02		
400	59,43	1500	43,13	3400	31,10		
500	57,08	1600	42,22	3600	30,23		
600	55,02	1700	41,36	3800	29,40		
700	53,18	1800	40,54	4000	28,61		

Tooth shear strength / rpm

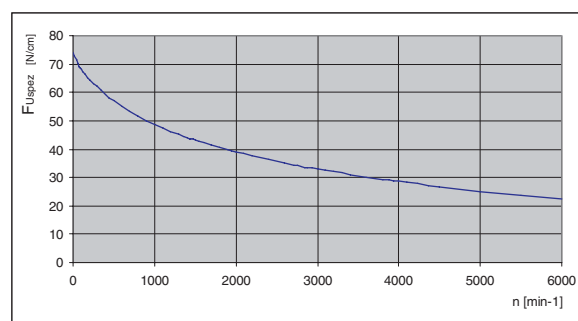

The specific load F_{Uspez} is the maximum load which one single belt tooth 1 cm wide can withstand in all operating conditions. This force is related to the drive rpm. The total load F_U transmissible by the belt in the drive is calculated by:

$$F_U [N] = F_{Uspez} \cdot z_e \cdot b$$

- $F_U [N]$ = peripheral force
- $F_{Uspez} [N/cm]$ = specific load
- z_e = number of teeth in mesh in the small pulley
- z_{emax} = max. no of teeth in mesh to be considered for the calculation of the drive
- $z_{emax} = 12$ for ELATECH® M
- $z_{emax} = 6$ for ELATECH® V
- $b [cm]$ = belt width in cm

Specialties

PROFILE	Belt width b [mm]	ARAMID CORD		STAINLESS STEEL		HPL High performance	
		F _{Tzul} [N] M type	F _{Br} [N]	F _{Tzul} [N] M type	F _{Br} [N]	F _{Tzul} [N] M type	F _{Br} [N]
STD8M	010	1140	4740	1080	4500		
	015	1710	7110	1620	6750		
	020	2470	10270	2340	9750	5280	19250
	030	3610	15010	3420	14250	7680	28000
	050	6650	27650	6300	26250	14400	52500
	085	11400	47400			26400	96250
	100	13490	56090				

Flexibility

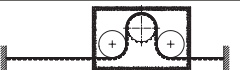
Minimum pulley number of teeth and minimum idler diameter					
STD8M		TYPE OF CORD			
		STANDARD	ARAMID	STAINLESS	HPL
Drive without reverse bending 	Timing pulley z _{min}	18	18	24	28
	Idler running on belt teeth d _{min}	50 mm	50 mm	80 mm	80 mm
Drive with reverse bending 	Timing pulley z _{min}	18	18	24	28
	Idler running on belt back d _{min}	120 mm	120 mm	150 mm	150 mm

Timing pulleys

z	da	dw	z	da	dw	z	da	dw	z	da	dw
18	44,46	45,83	47	118,31	119,68	76	192,16	193,53	105	266,01	267,38
19	47,01	48,38	48	120,86	122,23	77	194,71	196,08	106	268,55	269,92
20	49,56	50,93	49	123,40	124,77	78	197,25	198,62	107	271,10	272,47
21	52,10	53,47	50	125,95	127,32	79	199,80	201,17	108	273,64	275,01
22	54,65	56,02	51	128,50	129,87	80	202,35	203,72	109	276,19	277,56
23	57,20	58,57	52	131,04	132,41	81	204,89	206,26	110	278,74	280,11
24	59,75	61,12	53	133,59	134,96	82	207,44	208,81	111	281,29	282,66
25	62,29	63,66	54	136,14	137,51	83	209,98	211,35	112	283,84	285,21
26	64,84	66,21	55	138,68	140,05	84	212,53	213,90	113	286,38	287,75
27	67,38	68,75	56	141,23	142,60	85	215,08	216,45	114	288,93	290,30
28	69,93	71,30	57	143,78	145,15	86	217,63	219,00	115	291,47	292,84
29	72,47	73,84	58	146,32	147,69	87	220,17	221,54	116	294,02	295,39
30	75,02	76,39	59	148,87	150,24	88	222,72	224,09	117	296,57	297,94
31	77,57	78,94	60	151,42	152,79	89	225,26	226,63	118	299,11	300,48
32	80,12	81,49	61	153,96	155,33	90	227,81	229,18	119	301,66	303,03
33	82,66	84,03	62	156,52	157,89	91	230,35	231,72	120	304,20	305,57
34	85,21	86,58	63	159,06	160,43	92	232,90	234,27			
35	87,75	89,12	64	161,60	162,97	93	235,45	236,82			
36	90,30	91,67	65	164,15	165,52	94	238,00	239,37			
37	92,85	94,22	66	166,69	168,06	95	240,54	241,91			
38	95,40	96,77	67	169,24	170,61	96	243,09	244,46			
39	97,94	99,31	68	171,79	173,16	97	245,63	247,00			
40	100,49	101,86	69	174,33	175,70	98	248,18	249,55			
41	103,03	104,40	70	176,88	178,25	99	250,73	252,10			
42	105,58	106,95	71	179,43	180,80	100	253,30	254,67			
43	108,13	109,50	72	181,98	183,35	101	255,82	257,19			
44	110,68	112,05	73	184,52	185,89	102	258,37	259,74			
45	113,22	114,59	74	187,07	188,44	103	260,91	262,28			
46	115,77	117,14	75	189,61	190,98	104	263,46	264,83			

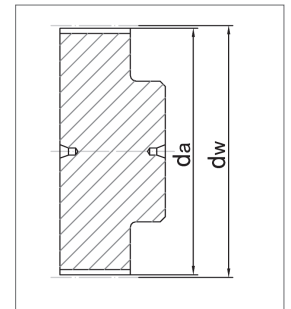

STD14M

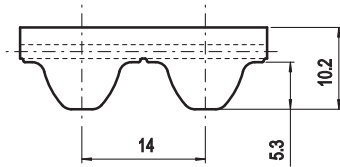

Belt characteristics

- Polyurethane timing belt with evolvent tooth, high tensile load steel cords and high torque capacity. Produced according to ISO 13050
 - Metric pitch 14 mm
 - Low noise generation in high speed drives
 - Tension cords with increased tensile load for lower elongation
 - Superior performance in lifting applications
 - The special profile allows smooth running properties
- Width tolerance: $\pm 1,0$ [mm]
 - Length tolerance: $\pm 0,5$ [mm/m]
 - Thickness tolerance: $\pm 0,4$ [mm]

Technical data

Belt width b [mm]	Allowable tensile load Type M F_{Tzul} [N]	Allowable tensile load Type V F_{Tzul} [N]	Breaking load Type M F_{Br} [N]	Specific spring rate C_{spez} [N]	Weight [kg/m]
40	12750	6375	48000	3187500	0,48
55	17850	8925	67200	4462500	0,65
85	28050	14025	105600	7012500	1,10
115	38250	19125	144000	9562500	1,40

Load / Elongation [%]

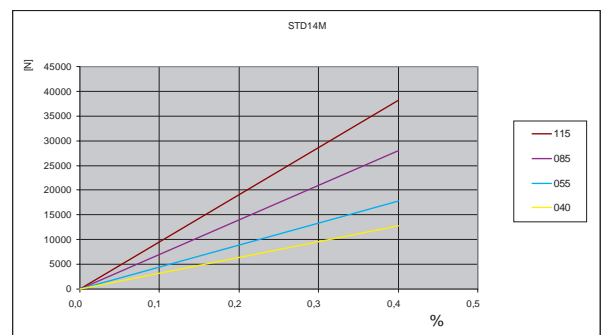

Other widths are available on request.

Tooth shear strength

rpm	F_{Uspez} [N/cm]	rpm	F_{Uspez} [N/cm]	rpm	F_{Uspez} [N/cm]	rpm	F_{Uspez} [N/cm]
0	134,00	800	88,80	1900	65,49	4000	43,24
20	131,31	900	85,85	2000	64,01		
40	128,83	1000	83,14	2200	61,23		
60	126,53	1100	80,63	2400	58,68		
80	124,42	1200	78,31	2600	56,30		
100	122,46	1300	76,14	2800	54,09		
200	114,77	1400	74,11	2880	53,24		
300	109,29	1440	73,33	3000	52,01		
400	104,19	1500	72,19	3200	50,06		
500	99,65	1600	70,38	3400	48,22		
600	95,64	1700	68,67	3600	46,48		
700	92,04	1800	67,04	3800	44,82		

Tooth shear strength / rpm

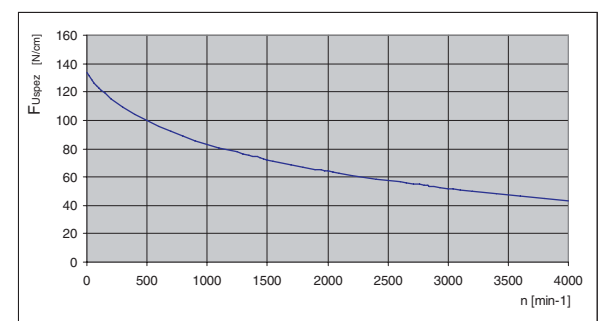

The specific load F_{Uspez} is the maximum load which one single belt tooth 1 cm wide can withstand in all operating conditions. This force is related to the drive rpm. The total load F_U transmissible by the belt in the drive is calculated by:

$$F_U [N] = F_{Uspez} \cdot Z_e \cdot b$$

- F_U [N] = peripheral force
- F_{Uspez} [N/cm] = specific load
- Z_e = number of teeth in mesh in the small pulley
- Z_{emax} = max. no of teeth in mesh to be considered for the calculation of the drive
- $Z_{emax} = 12$ for ELATECH® M
- $Z_{emax} = 6$ for ELATECH® V
- b [cm] = belt width in cm

Flexibility

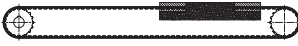
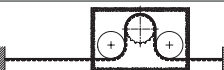
Minimum pulley number of teeth and minimum idler diameter		
STD14M		TYPE OF CORD
		STANDARD
Drive without reverse bending 	Timing pulley z_{min}	32
	Idler running on belt teeth d_{min}	140 mm
Drive with reverse bending 	Timing pulley z_{min}	32
	Idler running on belt back d_{min}	250 mm

Timing pulleys

z	da	dw	z	da	dw	z	da	dw	z	da	dw
28	122,12	124,77	57	251,22	254,01	86	380,46	383,23	115	509,69	512,47
29	126,58	129,22	58	255,68	258,46	87	384,91	387,70	116	514,14	516,93
30	130,99	133,69	59	260,14	262,91	88	389,37	392,15	117	518,60	521,38
31	135,45	138,14	60	264,60	267,38	89	393,83	396,60	118	523,06	525,83
32	139,88	142,59	61	269,04	271,83	90	398,29	401,07	119	527,51	530,30
33	144,35	147,06	62	273,50	276,28	91	402,73	405,52	120	531,97	534,75
34	148,79	151,51	63	277,96	280,75	92	407,19	409,97			
35	153,25	155,96	64	282,42	285,20	93	411,65	414,44			
36	157,68	160,41	65	286,88	289,65	94	416,10	418,89			
37	162,14	164,88	66	291,32	294,11	95	420,56	423,35			
38	166,60	169,34	67	295,78	298,56	96	425,02	427,80			
39	171,02	173,79	68	300,24	303,03	97	429,48	432,25			
40	175,48	178,24	69	304,70	307,48	98	433,94	436,72			
41	179,92	182,71	70	309,16	311,93	99	438,38	441,17			
42	184,37	187,16	71	313,61	316,40	100	442,84	445,62			
43	188,83	191,61	72	318,07	320,85	101	447,30	450,09			
44	193,29	196,08	73	322,53	325,30	102	451,76	454,54			
45	197,75	200,53	74	326,98	329,77	103	456,21	459,00			
46	202,21	204,98	75	331,44	334,22	104	460,67	463,45			
47	206,65	209,43	76	335,90	338,67	105	465,13	467,90			
48	211,11	213,90	77	340,34	343,12	106	469,58	472,37			
49	215,57	218,35	78	344,80	347,59	107	474,03	476,82			
50	220,03	222,80	79	349,26	352,04	108	478,49	481,28			
51	224,49	227,27	80	353,72	356,49	109	482,95	485,74			
52	228,95	231,72	81	358,17	360,96	110	487,41	490,19			
53	233,39	236,18	82	362,63	365,41	111	491,87	494,64			
54	237,85	240,64	83	367,09	369,86	112	496,32	499,10			
55	242,30	245,09	84	371,54	374,33	113	500,78	503,55			
56	246,76	249,55	85	376,00	378,78	114	505,23	508,02			

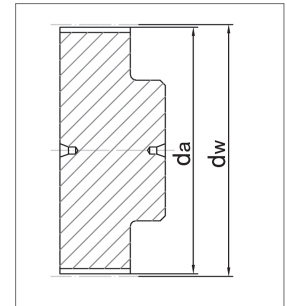

EAGLE 8M

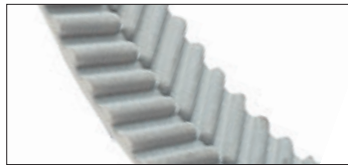
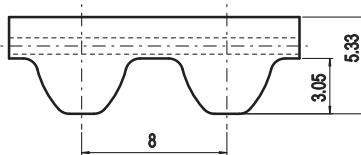

Belt characteristics

- Polyurethane timing belt with helical offset tooth, high tensile load steel cords and high torque capacity.
 - **Self tracking no need of pulley flanges**
 - Metric pitch 8 mm
 - **Extremely reduced noise generation**
 - Offers excellent operational reliability in linear positioning and medium power transmission applications
 - The special profile allows most compact drive
- Width tolerance: $\pm 0,8$ [mm]
 - Length tolerance: $\pm 0,8$ [mm/m]
 - Thickness tolerance: $\pm 0,3$ [mm]

Technical data

Belt width b [mm]	Allowable tensile load Type M F_{Tzul} [N]	Allowable tensile load Type V F_{Tzul} [N]	Breaking load Type M F_{Br} [N]	Specific spring rate C_{spez} [N]	Weight [kg/m]
16	2470	1200	8640	612500	0,085
25	4200	2100	14700	1042500	0,145
32	5430	2700	19000	1347500	0,180
50	8640	4300	30250	2145000	0,300

Load / Elongation [%]

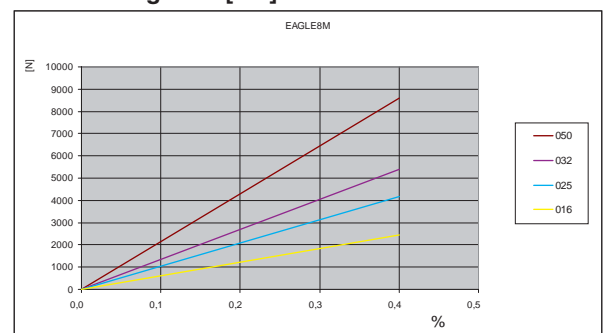

Tooth shear strength

rpm	F_{Uspez} [N/cm]	rpm	F_{Uspez} [N/cm]	rpm	F_{Uspez} [N/cm]	rpm	F_{Uspez} [N/cm]
0	85,00	800	59,66	1900	46,95	4000	34,75
20	83,78	900	58,05	2000	46,14	4500	32,75
40	82,62	1000	56,58	2200	44,62	5000	30,94
60	81,49	1100	55,22	2400	43,22	5500	29,30
80	80,42	1200	53,95	2600	41,91	6000	27,79
100	79,38	1300	52,77	2800	40,70		
200	74,78	1400	51,66	2880	40,24		
300	71,01	1440	51,23	3000	39,56		
400	67,93	1500	50,61	3200	38,49		
500	65,52	1600	49,62	3400	37,48		
600	63,36	1700	48,69	3600	36,52		
700	61,42	1800	47,80	3800	35,61		

Tooth shear strength / rpm

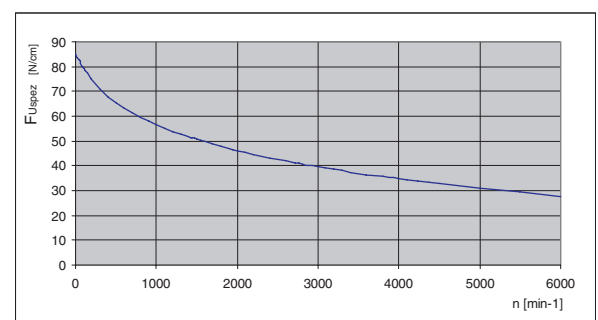

The specific load F_{Uspez} is the maximum load which one single belt tooth 1 cm wide can withstand in all operating conditions. This force is related to the drive rpm. The total load F_U transmissible by the belt in the drive is calculated by:

$$F_U [N] = F_{Uspez} \cdot Z_e \cdot b$$

- F_U [N] = peripheral force
- F_{Uspez} [N/cm] = specific load
- Z_e = number of teeth in mesh in the small pulley
- Z_{emax} = max. no of teeth in mesh to be considered for the calculation of the drive
- $Z_{emax} = 12$ for ELATECH® M
- $Z_{emax} = 6$ for ELATECH® V
- b [cm] = belt width in cm

Specialties

PROFILE	Belt width b [mm]	STAINLESS STEEL		HPL High performance	
		F _{Tzul} [N] M type	F _{Br} [N]	F _{Tzul} [N] M type	F _{Br} [N]
E 8M	016	1800	7500	3840	14000
	025	3060	12750	6720	24500
	032	3960	16500	8640	31500
	050	6300	26250	14400	52500

Flexibility

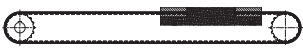
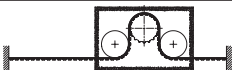
Minimum pulley number of teeth and minimum idler diameter				
E 8M		TYPE OF CORD		
		STANDARD	STAINLESS	HPL
Drive without reverse bending 	Timing pulley z _{min}	20	24	28
	Idler running on belt teeth d _{min}	50 mm	80 mm	80 mm
Drive with reverse bending 	Timing pulley z _{min}	20	24	28
	Idler running on belt back d _{min}	100 mm	100 mm	100 mm

Timing pulleys

z	da	dw	z	da	dw	z	da	dw	z	da	dw
18	44,46	45,83	47	118,31	119,68	76	192,16	193,53	105	266,01	267,38
19	47,01	48,38	48	120,86	122,23	77	194,71	196,08	106	268,55	269,92
20	49,56	50,93	49	123,40	124,77	78	197,25	198,62	107	271,10	272,47
21	52,10	53,47	50	125,95	127,32	79	199,80	201,17	108	273,64	275,01
22	54,65	56,02	51	128,50	129,87	80	202,35	203,72	109	276,19	277,56
23	57,20	58,57	52	131,04	132,41	81	204,89	206,26	110	278,74	280,11
24	59,75	61,12	53	133,59	134,96	82	207,44	208,81	111	281,29	282,66
25	62,29	63,66	54	136,14	137,51	83	209,98	211,35	112	283,84	285,21
26	64,84	66,21	55	138,68	140,05	84	212,53	213,90	113	286,38	287,75
27	67,38	68,75	56	141,23	142,60	85	215,08	216,45	114	288,93	290,30
28	69,93	71,30	57	143,78	145,15	86	217,63	219,00	115	291,47	292,84
29	72,47	73,84	58	146,32	147,69	87	220,17	221,54	116	294,02	295,39
30	75,02	76,39	59	148,87	150,24	88	222,72	224,09	117	296,57	297,94
31	77,57	78,94	60	151,42	152,79	89	225,26	226,63	118	299,11	300,48
32	80,12	81,49	61	153,96	155,33	90	227,81	229,18	119	301,66	303,03
33	82,66	84,03	62	156,52	157,89	91	230,35	231,72	120	304,20	305,57
34	85,21	86,58	63	159,06	160,43	92	232,90	234,27			
35	87,75	89,12	64	161,60	162,97	93	235,45	236,82			
36	90,30	91,67	65	164,15	165,52	94	238,00	239,37			
37	92,85	94,22	66	166,69	168,06	95	240,54	241,91			
38	95,40	96,77	67	169,24	170,61	96	243,09	244,46			
39	97,94	99,31	68	171,79	173,16	97	245,63	247,00			
40	100,49	101,86	69	174,33	175,70	98	248,18	249,55			
41	103,03	104,40	70	176,88	178,25	99	250,73	252,10			
42	105,58	106,95	71	179,43	180,80	100	253,30	254,67			
43	108,13	109,50	72	181,98	183,35	101	255,82	257,19			
44	110,68	112,05	73	184,52	185,89	102	258,37	259,74			
45	113,22	114,59	74	187,07	188,44	103	260,91	262,28			
46	115,77	117,14	75	189,61	190,98	104	263,46	264,83			

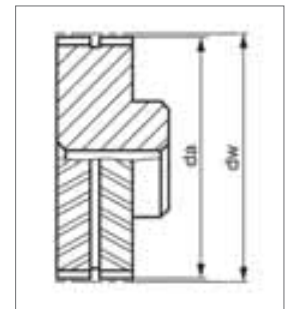

EAGLE 14M

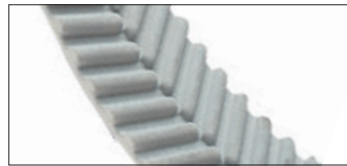
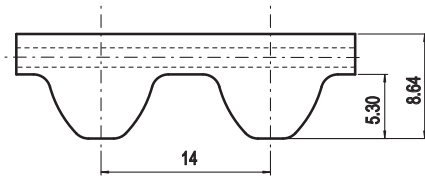

Belt characteristics

- Polyurethane timing belt with helical offset tooth, high tensile load steel cords and high torque capacity.
 - **Self tracking no need of pulley flanges**
 - Metric pitch 14 mm
 - **Extremely reduced noise generation**
 - Offers excellent operational reliability in linear positioning, heavy power transmission and lifting applications
 - The special profile allows most compact drive
- Width tolerance: $\pm 1,2$ [mm]
 - Length tolerance: $\pm 0,8$ [mm/m]
 - Thickness tolerance: $\pm 0,4$ [mm]

Technical data

Belt width b [mm]	Allowable tensile load Type M F_{Tzul} [N]	Allowable tensile load Type V F_{Tzul} [N]	Breaking load Type M F_{Br} [N]	Specific spring rate C_{spez} [N]	Weight [kg/m]
35	9300	4650	37800	2762500	0,400
52	14700	7350	55800	4250000	0,600
70	19600	9800	74400	5737500	0,800
105	32600	16300	114000	8712500	1,200

Load / Elongation [%]

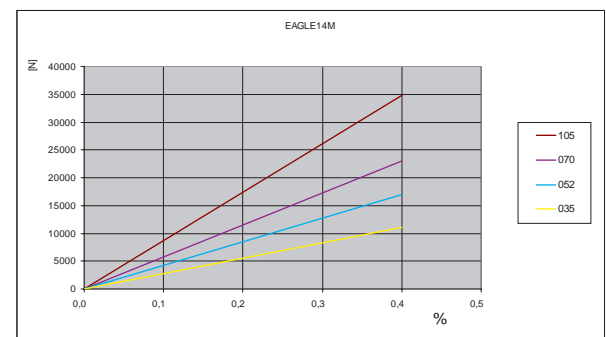

Tooth shear strength

rpm	F_{Uspez} [N/cm]	rpm	F_{Uspez} [N/cm]	rpm	F_{Uspez} [N/cm]	rpm	F_{Uspez} [N/cm]
0	160,00	800	103,35	1900	73,99	4000	46,21
20	157,00	900	99,60	2000	72,13		
40	154,22	1000	96,17	2200	68,66		
60	151,64	1100	93,01	2400	65,46		
80	149,24	1200	90,08	2600	62,50		
100	147,01	1300	87,35	2800	59,73		
200	138,04	1400	84,80	2880	58,68		
300	129,87	1440	83,82	3000	57,15		
400	123,12	1500	82,39	3200	54,71		
500	117,24	1600	80,12	3400	52,42		
600	112,07	1700	77,97	3600	50,24		
700	107,48	1800	75,93	3800	48,18		

Tooth shear strength / rpm

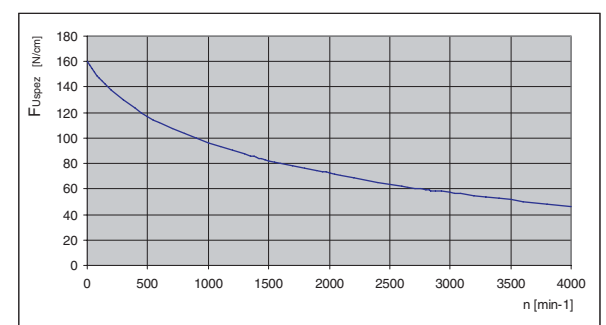



The specific load F_{Uspez} is the maximum load which one single belt tooth 1 cm wide can withstand in all operating conditions. This force is related to the drive rpm. The total load F_U transmissible by the belt in the drive is calculated by:

$$F_U [N] = F_{Uspez} \cdot z_e \cdot b$$

- F_U [N] = peripheral force
- F_{Uspez} [N/cm] = specific load
- z_e = number of teeth in mesh in the small pulley
- z_{emax} = max. no of teeth in mesh to be considered for the calculation of the drive
- $z_{emax} = 12$ for ELATECH® M
- $z_{emax} = 6$ for ELATECH® V
- b [cm] = belt width in cm

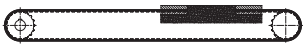
Flexibility

Minimum pulley number of teeth and minimum idler diameter		
PROFILE	E 14M	TYPE OF CORD
		STANDARD
Drive without reverse bending 	Timing pulley z_{min}	32
	Idler running on belt teeth d_{min}	160 mm
Drive with reverse bending 	Timing pulley z_{min}	32
	Idler running on belt back d_{min}	250 mm

Timing pulleys

z	da	dw	z	da	dw	z	da	dw	z	da	dw
28	122,12	124,77	57	251,22	254,01	86	380,46	383,23	115	509,69	512,47
29	126,58	129,22	58	255,68	258,46	87	384,91	387,70	116	514,14	516,93
30	130,99	133,69	59	260,14	262,91	88	389,37	392,15	117	518,60	521,38
31	135,45	138,14	60	264,60	267,38	89	393,83	396,60	118	523,06	525,83
32	139,88	142,59	61	269,04	271,83	90	398,29	401,07	119	527,51	530,30
33	144,35	147,06	62	273,50	276,28	91	402,73	405,52	120	531,97	534,75
34	148,79	151,51	63	277,96	280,75	92	407,19	409,97			
35	153,25	155,96	64	282,42	285,20	93	411,65	414,44			
36	157,68	160,41	65	286,88	289,65	94	416,10	418,89			
37	162,14	164,88	66	291,32	294,11	95	420,56	423,35			
38	166,60	169,34	67	295,78	298,56	96	425,02	427,80			
39	171,02	173,79	68	300,24	303,03	97	429,48	432,25			
40	175,48	178,24	69	304,70	307,48	98	433,94	436,72			
41	179,92	182,71	70	309,16	311,93	99	438,38	441,17			
42	184,37	187,16	71	313,61	316,40	100	442,84	445,62			
43	188,83	191,61	72	318,07	320,85	101	447,30	450,09			
44	193,29	196,08	73	322,53	325,30	102	451,76	454,54			
45	197,75	200,53	74	326,98	329,77	103	456,21	459,00			
46	202,21	204,98	75	331,44	334,22	104	460,67	463,45			
47	206,65	209,43	76	335,90	338,67	105	465,13	467,90			
48	211,11	213,90	77	340,34	343,12	106	469,58	472,37			
49	215,57	218,35	78	344,80	347,59	107	474,03	476,82			
50	220,03	222,80	79	349,26	352,04	108	478,49	481,28			
51	224,49	227,27	80	353,72	356,49	109	482,95	485,74			
52	228,95	231,72	81	358,17	360,96	110	487,41	490,19			
53	233,39	236,18	82	362,63	365,41	111	491,87	494,64			
54	237,85	240,64	83	367,09	369,86	112	496,32	499,10			
55	242,30	245,09	84	371,54	374,33	113	500,78	503,55			
56	246,76	249,55	85	376,00	378,78	114	505,23	508,02			

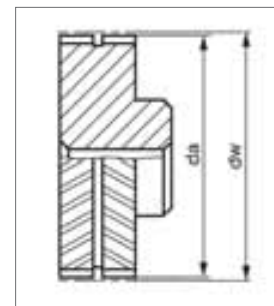

TK5 - K6

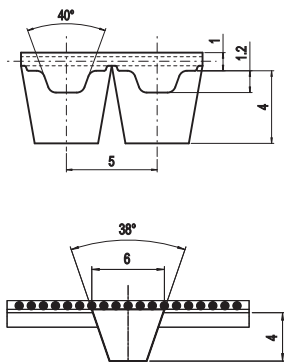

Belt characteristics

- Polyurethane self tracking timing belt with steel tension cords
- Profile T5 with central guide - K6 x 4 mm
- Central guide height 4,0 mm
- Allow to use pulleys without flanges
- The central guide is notched in order to maximize belt flexibility
- Ideal for conveying applications where a side load is generated by loading/unloading transferring a product

Technical data

Belt width b [mm]	Allowable tensile load Type M F_{Tzul} [N]	Allowable tensile load Type V F_{Tzul} [N]	Breaking load Type M F_{Br} [N]	Specific spring rate C_{spez} [N]	Weight [kg/m]
032	1150	575	4500	287500	0,08
050	1860	930	7250	465000	0,13
075	2820	1410	11000	705000	0,20
100	3780	1890	14750	945000	0,26

Load / Elongation [%]

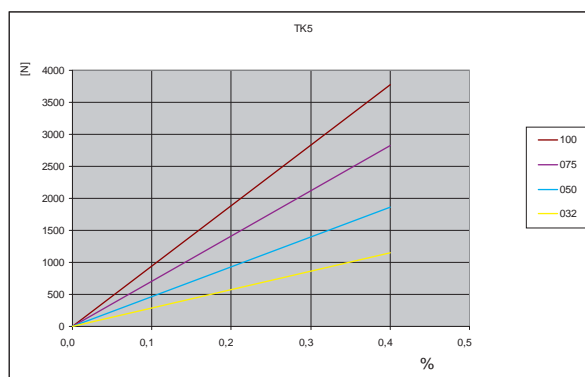

Specialties

PROFILE	Belt width b [mm]	ARAMID CORD	
		F_{Tzul} [N] M type	F_{Br} [N]
TK5	032	2520	10080
	050	4060	16240
	075	6160	24640
	100	8260	33040

Pulley profile

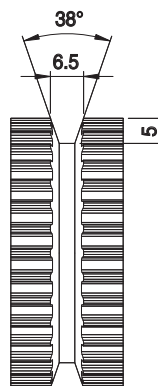

Flexibility

Minimum number of teeth and minimum diameter			
PROFILE	TK5	TYPE OF CORD	
		STANDARD	ARAMID
Drive without reverse bending 	Timing pulley z_{min}	25	25
	Idler running on belt teeth d_{min}	60 mm	60 mm
Drive with reverse bending 	Timing pulley z_{min}	25	25
	Idler running on belt back d_{min}	80 mm	80 mm

TK10 - K13

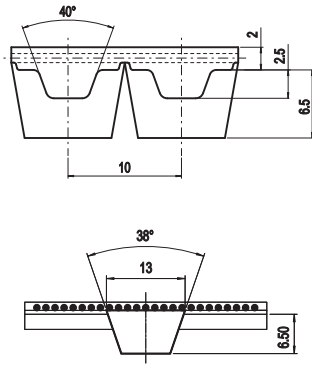

Belt characteristics

- Polyurethane self track timing belt with steel tension cords
- Profile T10 with central guide - K13 x 6,5
- Central guide height 6,5 mm
- Allow to use pulleys without flanges
- The central guide is notched in order to maximize belt flexibility
- Ideal for conveying applications where a side load is generated by loading/unloading transferring a product

Technical data

Belt width b [mm]	Allowable tensile load Type M F_{Tzul} [N]	Allowable tensile load Type V F_{Tzul} [N]	Breaking load Type M F_{Br} [N]	Specific spring rate C_{spez} [N]	Weight [kg/m]
032	3450	1725	12600	862500	0,22
050	5520	2760	20160	1380000	0,30
075	8400	4200	30660	2100000	0,41
100	11270	5635	41160	2817500	0,53

Load / Elongation [%]

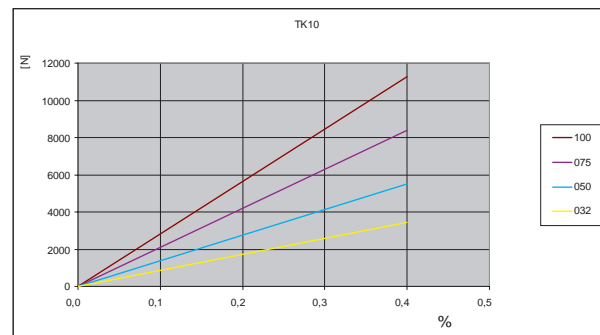

Specialties

PROFILE	Belt width b [mm]	ARAMID CORD	
		F_{Tzul} [N] M type	F_{Br} [N]
TK10	032	3300	13500
	050	5280	21600
	075	8030	32850
	100	10780	44100

Pulley profile

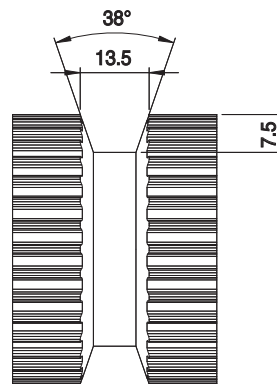

Flexibility

Minimum pulley number of teeth and minimum idler diameter			
PROFILE	TK10	TYPE OF CORD	
		STANDARD	ARAMID
 Drive without reverse bending	Timing pulley z_{min}	25	25
	Idler running on belt teeth d_{min}	80 mm	80 mm
 Drive with reverse bending	Timing pulley z_{min}	25	25
	Idler running on belt back d_{min}	80 mm	80 mm

ATK5 - K6

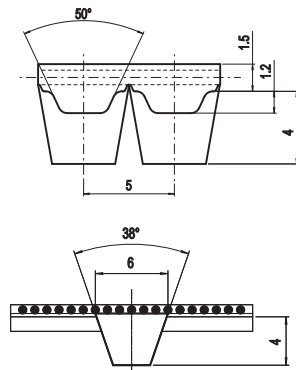

Belt characteristics

- Polyurethane self track timing belt with steel tension cords
- Profile AT5 with central guide - K6 x 4 mm
- Central guide height 4,0 mm
- Allow to use pulleys without flanges
- The central guide is notched in order to maximize belt flexibility
- Ideal for conveying applications where a side load is generated by loading/unloading transferring a product

Technical data

Belt width b [mm]	Allowable tensile load Type M F_{Tzul} [N]	Allowable tensile load Type V F_{Tzul} [N]	Breaking load Type M F_{Br} [N]	Specific spring rate C_{spez} [N]	Weight [kg/m]
032	3450	1725	12600	862500	0,11
050	5520	2760	20160	1380000	0,19
075	8400	4200	30660	2100000	0,29
100	11270	5635	41160	2817500	0,38

Load / Elongation [%]

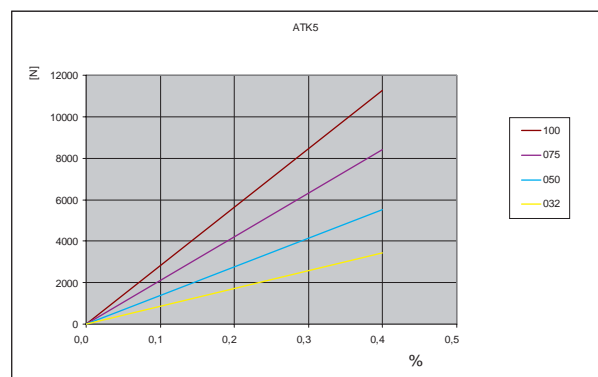

Specialties

PROFILE	Belt width b [mm]	ARAMID CORD	
		F_{Tzul} [N] M type	F_{Br} [N]
ATK5	032	3300	13500
	050	5280	21600
	075	8030	32850
	100	10780	44100

Pulley profile

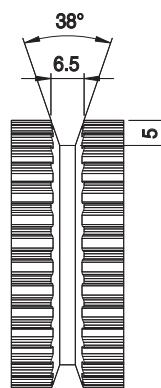

Flexibility

Minimum pulley number of teeth and minimum idler diameter			
PROFILE	ATK5	TYPE OF CORD	
		STANDARD	ARAMID
Drive without reverse bending 	Timing pulley z_{min}	25	25
	Idler running on belt teeth d_{min}	60 mm	60 mm
Drive with reverse bending 	Timing pulley z_{min}	25	25
	Idler running on belt back d_{min}	80 mm	80 mm

ATK10 - K13

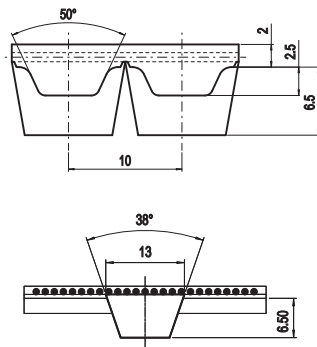

Belt characteristics

- Polyurethane self track timing belt with steel tension cords
- Profile AT10 with central guide - K13 x 6,5 mm
- Central guide height 6,5 mm
- Allow to use pulleys without flanges
- The central guide is notched in order to maximize belt flexibility
- Ideal for conveying applications where a side load is generated by loading/unloading transferring a product

Technical data

Belt width b [mm]	Allowable tensile load Type M F_{Tzul} [N]	Allowable tensile load Type V F_{Tzul} [N]	Breaking load Type M F_{Br} [N]	Specific spring rate C_{spez} [N]	Weight [kg/m]
032	5390	2695	20900	1347500	0,27
050	8580	4290	33250	2145000	0,36
075	12990	6495	50350	3247500	0,50
100	17400	8700	67450	4350000	0,72
150	26220	13110	101650	6555000	1,08

Load / Elongation [%]

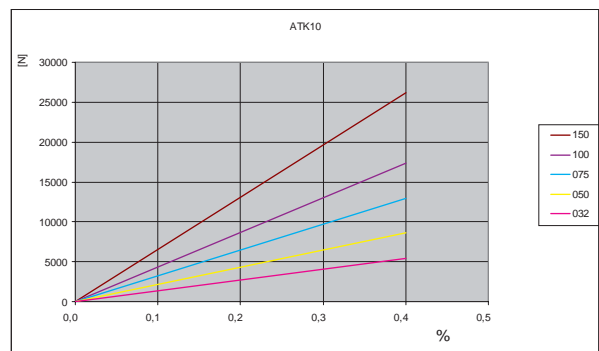

Specialties

PROFILE	Belt width b [mm]	ARAMID CORD	
		F_{Tzul} [N] M type	F_{Br} [N]
ATK10	032	4180	17380
	050	6650	27650
	075	10070	41870
	100	13490	56090
	150	20330	84530

Pulley profile

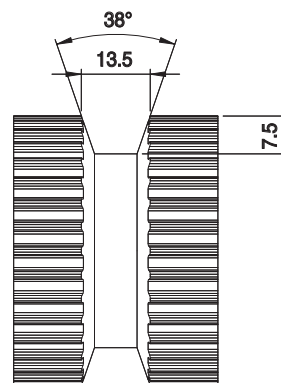

Flexibility

Minimum pulley number of teeth and minimum idler diameter			
PROFILE	ATK10	TYPE OF CORD	
		STANDARD	ARAMID
 Drive without reverse bending	Timing pulley z_{min}	25	25
	Idler running on belt teeth d_{min}	80 mm	80 mm
 Drive with reverse bending	Timing pulley z_{min}	25	25
	Idler running on belt back d_{min}	120 mm	120 mm

T10

TOTAL PROTECTION

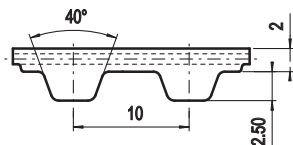

Belt characteristics

- Polyurethane timing belt with steel tension cords
- Trapezoidal tooth profile according to DIN 7721 T1
- Metric pitch 10 mm
- **TP (Total Protection) belt. The absence of tooth gap makes the belt protected against corrosion**
- **Widely used in application with corrosive environment**

- Width tolerance: $\pm 0,5$ [mm]
- Length tolerance: $\pm 0,5$ [mm/m]
- Thickness tolerance: $\pm 0,2$ [mm]

Technical data

Belt width b [mm]	Allowable tensile load Type M F _{Tzul} [N]	Allowable tensile load Type V F _{Tzul} [N]	Breaking load Type M F _{Br} [N]	Specific spring rate C _{spez} [N]	Weight [kg/m]
10	920	460	3360	230000	0,05
16	1610	805	5880	402500	0,07
25	2650	1325	9660	662500	0,11
32	3450	1725	12600	862500	0,15
50	5520	2760	20160	1380000	0,23
75	8400	4200	30660	2100000	0,34
100	11270	5635	41160	2817500	0,45

Load / Elongation [%]

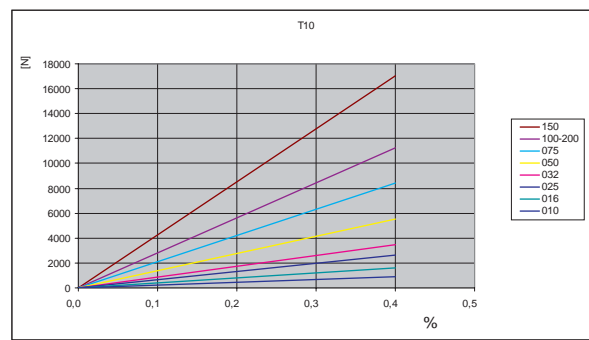

Other widths are available on request.

Tooth shear strength

rpm	F _{Uspez} [N/cm]	rpm	F _{Uspez} [N/cm]	rpm	F _{Uspez} [N/cm]	rpm	F _{Uspez} [N/cm]
0	51,80	800	33,34	1900	26,53	4500	19,40
20	50,32	900	32,44	2000	26,12	5000	18,51
40	49,04	1000	31,63	2200	25,34	5500	17,70
60	47,92	1100	30,89	2400	24,63	6000	16,97
80	46,95	1200	30,21	2600	23,97	6500	16,29
100	46,11	1300	29,58	2800	23,36	7000	15,66
200	42,75	1400	28,99	3000	22,78	7500	15,07
300	40,28	1440	28,76	3200	22,25	8000	14,52
400	38,36	1500	28,44	3400	21,74	8500	14,00
500	36,80	1600	27,92	3600	21,27	9000	13,51
600	35,49	1700	27,43	3800	20,81	9500	13,05
700	34,35	1800	26,97	4000	20,39	10000	12,61

Tooth shear strength / rpm

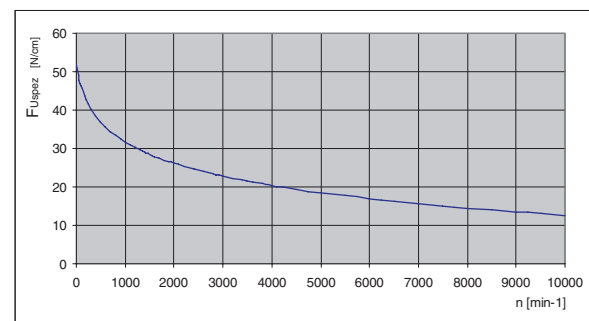

The specific load F_{Uspez} is the maximum load which one single belt tooth 1 cm wide can withstand in all operating conditions. This force is related to the drive rpm. The total load F_U transmissible by the belt in the drive is calculated by:

$$F_U [N] = F_{Uspez} \cdot z_e \cdot b$$

- F_U [N] = peripheral force
- F_{Uspez} [N/cm] = specific load
- z_e = number of teeth in mesh in the small pulley
- z_{emax} = max. no of teeth in mesh to be considered for the calculation of the drive
- z_{emax} = 12 for ELATECH® M
- z_{emax} = 6 for ELATECH® V
- b [cm] = belt width in cm

Flexibility

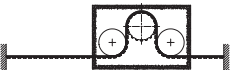
Minimum pulley number of teeth and minimum idler diameter		
T10 TP		TYPE OF CORD
		STANDARD
Drive without reverse bending 	Timing pulley z_{min}	12
	Idler running on belt teeth d_{min}	60 mm
Drive with reverse bending 	Timing pulley z_{min}	20
	Idler running on belt back d_{min}	60 mm

Timing pulleys

z	da	dw	z	da	dw	z	da	dw	z	da	dw
10	30,05	31,84	39	122,30	124,14	68	214,60	216,44	97	306,90	308,75
11	33,25	35,02	40	125,45	127,32	69	217,75	219,63	98	310,10	311,93
12	36,35	38,20	41	128,65	130,50	70	220,95	222,81	99	313,25	315,12
13	39,50	41,38	42	131,85	133,69	71	224,15	225,99	100	316,45	318,30
14	42,70	44,56	43	135,00	136,87	72	227,30	229,18	101	319,65	321,48
15	45,90	47,75	44	138,20	140,05	73	230,50	232,36	102	322,80	324,66
16	49,05	50,93	45	141,40	143,24	74	233,70	235,54	103	326,00	327,85
17	52,25	54,11	46	144,60	146,42	75	236,90	238,72	104	329,20	331,03
18	55,45	57,29	47	147,75	149,60	76	240,05	241,94	105	332,35	334,21
19	58,65	60,48	48	150,95	152,78	77	243,25	245,09	106	335,55	337,40
20	61,80	63,66	49	154,10	155,97	78	246,40	248,27	107	338,75	340,58
21	65,00	66,84	50	157,30	159,15	79	249,60	251,46	108	341,95	343,76
22	68,15	70,03	51	160,50	162,33	80	252,80	254,64	109	345,15	346,95
23	71,35	73,20	52	163,65	165,52	81	256,00	257,82	110	348,30	350,13
24	74,55	76,39	53	166,85	168,70	82	259,15	261,00	111	351,45	353,31
25	77,70	79,58	54	170,05	171,88	83	262,30	264,19	112	354,65	356,50
26	80,90	82,76	55	173,20	175,06	84	265,50	267,37	113	357,80	359,68
27	84,10	85,95	56	176,40	178,25	85	268,70	270,55	114	361,00	362,86
28	87,25	89,12	57	179,60	181,43	86	271,90	273,74	115	364,19	366,04
29	90,45	92,21	58	182,75	184,61	87	275,05	276,92	116	367,39	369,23
30	93,65	95,49	59	185,95	187,80	88	278,25	280,10	117	370,56	372,41
31	96,85	98,67	60	189,10	190,98	89	281,45	283,28	118	373,76	375,59
32	100,00	101,86	61	192,30	194,16	90	284,60	286,47	119	376,93	378,78
33	103,20	105,04	62	195,50	197,35	91	287,80	289,65	120	380,11	381,96
34	106,40	108,22	63	198,65	200,53	92	291,00	292,84			
35	109,55	111,41	64	201,85	203,71	93	294,20	296,02			
36	112,75	114,59	65	205,05	206,90	94	297,35	299,20			
37	115,90	117,77	66	208,20	210,08	95	300,55	302,39			
38	119,10	120,95	67	211,40	213,26	96	303,75	305,57			

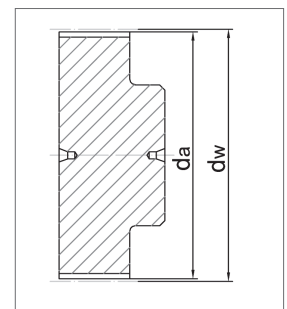

AT10

TOTAL PROTECTION

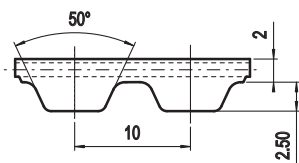

Belt characteristics

- Polyurethane timing belt with steel tension cords.
 - Metric pitch 10 mm
 - Tooth profile and dimension are optimised to guarantee uniform load distribution and minimum deformation under load.
 - High resistance and low stretch steel cords to guarantee high stability and low elongation.
 - Reduced polygonal effect with reduced drive vibration.
 - **TP (Total Protection) belt. The absence of tooth gap makes the belt protected against corrosion**
 - **Widely used in application with corrosive environment**
- Width tolerance: $\pm 0,5$ [mm]
 - Length tolerance: $\pm 0,8$ [mm/m]
 - Thickness tolerance: $\pm 0,2$ [mm]

Technical data

Belt width b [mm]	Allowable tensile load Type M F_{Tzul} [N]	Allowable tensile load Type V F_{Tzul} [N]	Breaking load Type M F_{Br} [N]	Specific spring rate C_{spez} [N]	Weight [kg/m]
16	2450	1225	9500	612500	0,09
25	4170	2085	16150	1042500	0,15
32	5390	2695	20900	1347500	0,19
50	8580	4290	33250	2145000	0,30
75	12990	6495	50350	3247500	0,44
100	17400	8700	67450	4350000	0,59

Load / Elongation [%]

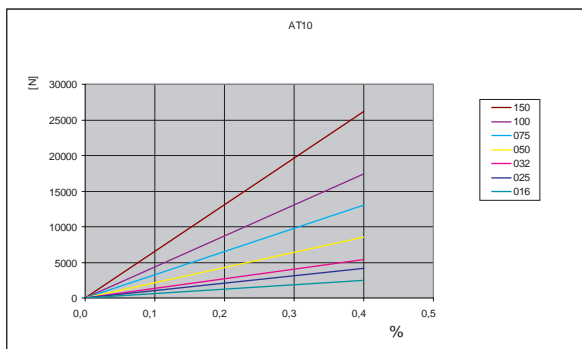

Other widths are available on request.

Tooth shear strength

rpm	F_{Uspez} [N/cm]	rpm	F_{Uspez} [N/cm]	rpm	F_{Uspez} [N/cm]	rpm	F_{Uspez} [N/cm]
0	75,70	800	53,70	1900	42,02	4500	29,13
20	74,59	900	52,21	2000	41,28	5000	27,50
40	73,55	1000	50,85	2200	39,89	5500	26,01
60	72,57	1100	49,59	2400	38,62	6000	24,65
80	71,65	1200	48,43	2600	37,44	6500	23,40
100	70,78	1300	47,34	2800	36,33	7000	22,23
200	67,13	1400	46,32	3000	35,30	7500	21,14
300	64,18	1440	45,93	3200	34,33	8000	20,12
400	61,53	1500	45,36	3400	33,41	8500	19,15
500	59,21	1600	44,46	3600	32,55	9000	18,24
600	57,16	1700	43,60	3800	31,72	9500	17,38
700	55,34	1800	42,79	4000	30,94	10000	16,56

Tooth shear strength / rpm

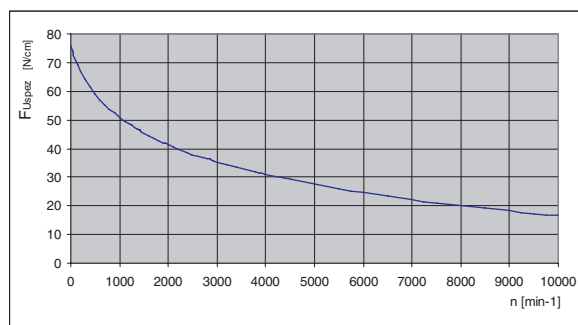

The specific load F_{Uspez} is the maximum load which one single belt tooth 1 cm wide can withstand in all operating conditions. This force is related to the drive rpm. The total load F_U transmissible by the belt in the drive is calculated by:

$$F_U [N] = F_{Uspez} \cdot z_e \cdot b$$

- F_U [N] = peripheral force
- F_{Uspez} [N/cm] = specific load
- z_e = number of teeth in mesh in the small pulley
- z_{emax} = max. no of teeth in mesh to be considered for the calculation of the drive
- $z_{emax} = 12$ for ELATECH® M
- $z_{emax} = 6$ for ELATECH® V
- b [cm] = belt width in cm

Flexibility

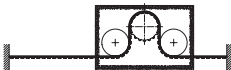
Minimum pulley number of teeth and minimum idler diameter		
AT10 TP		TYPE OF CORD
		STANDARD
Drive without reverse bending 	Timing pulley z_{min}	15
	Idler running on belt teeth d_{min}	50 mm
Drive with reverse bending 	Timing pulley z_{min}	25
	Idler running on belt back d_{min}	120 mm

Timing pulleys

z	da	dw	z	da	dw	z	da	dw	z	da	dw
18	55,45	57,29	47	147,75	149,60	76	240,05	241,94	105	332,35	334,21
19	58,60	60,48	48	150,95	152,78	77	243,25	245,09	106	335,55	337,40
20	61,80	63,66	49	154,10	155,97	78	246,40	248,24	107	338,75	340,58
21	65,00	66,84	50	157,30	159,15	79	249,60	251,46	108	341,90	343,76
22	68,15	70,03	51	160,50	162,33	80	252,80	254,64	109	345,10	346,95
23	71,35	73,20	52	163,65	165,52	81	255,95	257,82	110	348,30	350,13
24	74,55	76,39	53	166,85	168,70	82	259,15	261,00	111	351,45	353,31
25	77,70	79,58	54	170,05	171,88	83	262,30	264,19	112	354,65	356,50
26	80,90	82,76	55	173,20	175,06	84	265,50	267,37	113	357,80	359,68
27	84,10	85,95	56	176,40	178,25	85	268,70	270,52	114	361,00	362,86
28	87,25	89,12	57	179,60	181,43	86	271,90	273,74	115	364,19	366,04
29	90,45	92,21	58	182,75	184,61	87	275,05	276,92	116	367,39	369,23
30	93,65	95,49	59	185,95	187,80	88	278,25	280,10	117	370,56	372,41
31	96,80	98,67	60	189,10	190,98	89	281,45	283,28	118	373,74	375,59
32	100,00	101,86	61	192,30	194,16	90	284,60	286,47	119	376,93	378,78
33	103,20	105,04	62	195,50	197,35	91	287,80	289,65	120	380,11	381,96
34	106,40	108,19	63	198,65	200,53	92	291,00	292,84			
35	109,55	111,41	64	201,85	203,71	93	294,20	296,02			
36	112,75	114,59	65	205,05	206,90	94	297,35	299,20			
37	115,90	117,77	66	208,20	210,08	95	300,55	302,39			
38	119,10	120,95	67	211,40	213,26	96	303,70	305,57			
39	122,30	124,14	68	214,60	216,44	97	306,90	308,75			
40	125,45	127,32	69	217,75	219,63	98	310,10	311,93			
41	128,65	130,50	70	220,95	222,81	99	313,25	315,12			
42	131,85	133,69	71	224,15	225,99	100	316,45	318,30			
43	135,00	136,87	72	227,30	229,18	101	319,65	321,48			
44	138,20	140,05	73	230,50	232,33	102	322,80	324,66			
45	141,40	143,24	74	233,70	235,54	103	326,00	327,85			
46	144,55	146,42	75	236,90	238,72	104	329,20	331,03			

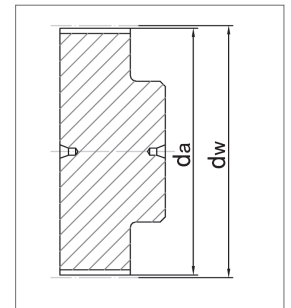

HTD8M

TOTAL PROTECTION

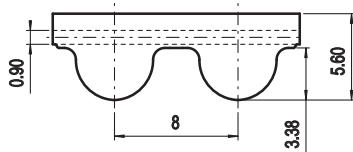

Belt characteristics

- Polyurethane timing belt with round tooth profile and high tensile load tension cords. Produced according to ISO 13050
 - Metric pitch 8 mm
 - The round tooth profile allows a uniform load distribution that guarantees high performances, high transmissible torque and precise tooth engagement
 - **TP (Total Protection) belt. The absence of tooth gap makes the belt protected against corrosion.**
 - **Widely used in application with corrosive environment**
- Width tolerance: $\pm 0,5$ [mm]
 - Length tolerance: $\pm 0,5$ [mm/m]
 - Thickness tolerance: $\pm 0,2$ [mm]

Technical data

Belt width b [mm]	Allowable tensile load Type M F_{Tzul} [N]	Allowable tensile load Type V F_{Tzul} [N]	Breaking load Type M F_{Br} [N]	Specific spring rate C_{spez} [N]	Weight [kg/m]
10	1470	735	5700	367500	0,07
15	2210	1105	8550	552500	0,10
20	3190	1595	12350	797500	0,14
30	4900	2450	19000	1225000	0,21
50	8580	4290	33250	2145000	0,35
85	14700	7350	57000	3675000	0,59
100	17400	8700	67450	4350000	0,69

Load / Elongation [%]

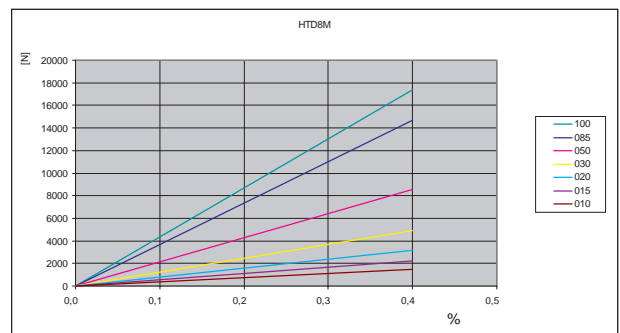

Other widths are available on request.

Tooth shear strength

rpm	F_{Uspez} [N/cm]	rpm	F_{Uspez} [N/cm]	rpm	F_{Uspez} [N/cm]	rpm	F_{Uspez} [N/cm]
0	74,00	800	51,20	1900	39,52	4500	26,63
20	72,62	900	49,71	2000	38,78	5000	25,00
40	71,34	1000	48,35	2200	37,39	5500	23,51
60	70,16	1100	47,09	2400	36,12	6000	22,15
80	69,07	1200	45,93	2600	34,94		
100	68,07	1300	44,84	2800	33,83		
200	64,09	1400	43,82	3000	32,80		
300	61,68	1440	43,43	3200	31,83		
400	59,03	1500	42,86	3400	30,91		
500	56,71	1600	41,96	3600	30,05		
600	54,66	1700	41,10	3800	29,22		
700	52,84	1800	40,29	4000	28,44		

Tooth shear strength / rpm

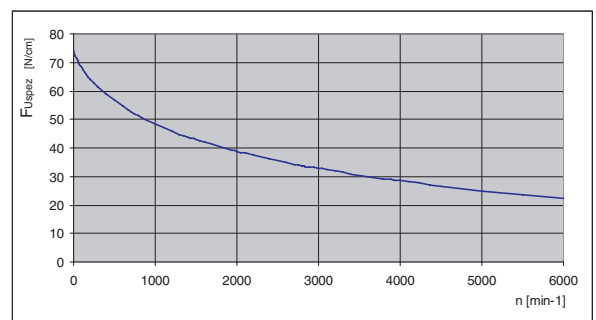

The specific load F_{Uspez} is the maximum load which one single belt tooth 1 cm wide can withstand in all operating conditions. This force is related to the drive rpm. The total load F_U transmissible by the belt in the drive is calculated by:

$$F_U \text{ [N]} = F_{Uspez} \cdot Z_e \cdot b$$

F_U [N] = peripheral force
 F_{Uspez} [N/cm] = specific load
 Z_e = number of teeth in mesh in the small pulley
 Z_{emax} = max. no of teeth in mesh to be considered for the calculation of the drive
 $Z_{emax} = 12$ for ELATECH® M
 $Z_{emax} = 6$ for ELATECH® V
 b [cm] = belt width in cm

Flexibility

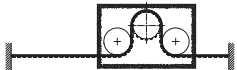
Minimum pulley number of teeth and minimum idler diameter		
HTD8M TP		TYPE OF CORD
		STANDARD
Drive without reverse bending 	Timing pulley z_{\min}	18
	Idler running on belt teeth d_{\min}	50 mm
Drive with reverse bending 	Timing pulley z_{\min}	18
	Idler running on belt back d_{\min}	120 mm

Timing pulleys

z	da	dw	z	da	dw	z	da	dw	z	da	dw
18	44,46	45,83	47	118,31	119,68	76	192,16	193,53	105	266,01	267,38
19	47,01	48,38	48	120,86	122,23	77	194,71	196,08	106	268,55	269,92
20	49,56	50,93	49	123,40	124,77	78	197,25	198,62	107	271,10	272,47
21	52,10	53,47	50	125,95	127,32	79	199,80	201,17	108	273,64	275,01
22	54,65	56,02	51	128,50	129,87	80	202,35	203,72	109	276,19	277,56
23	57,20	58,57	52	131,05	132,41	81	204,89	206,26	110	278,74	280,11
24	59,75	61,12	53	133,59	134,96	82	207,44	208,81	111	281,29	282,66
25	62,29	63,66	54	136,14	137,51	83	209,98	211,35	112	283,84	285,21
26	64,84	66,21	55	138,68	140,05	84	212,53	213,90	113	286,38	287,75
27	67,38	68,75	56	141,23	142,60	85	215,08	216,45	114	288,93	290,30
28	70,08	71,30	57	143,78	145,15	86	217,63	219,00	115	291,47	292,84
29	72,59	73,84	58	146,32	147,69	87	220,17	221,54	116	294,02	295,39
30	75,13	76,39	59	148,87	150,24	88	222,72	224,09	117	296,57	297,94
31	77,65	78,94	60	151,42	152,79	89	225,26	226,63	118	299,11	300,48
32	80,16	81,49	61	153,96	155,33	90	227,81	229,18	119	301,66	303,03
33	82,68	84,03	62	156,52	157,89	91	230,35	231,72	120	304,20	305,57
34	85,21	86,58	63	159,06	160,43	92	232,90	234,27			
35	87,76	89,12	64	161,60	162,97	93	235,45	236,82			
36	90,30	91,67	65	164,15	165,52	94	238,00	239,37			
37	92,85	94,22	66	166,69	168,06	95	240,54	241,91			
38	95,40	96,77	67	169,24	170,61	96	243,09	244,46			
39	97,94	99,31	68	171,79	173,16	97	245,63	247,00			
40	100,49	101,86	69	174,33	175,70	98	248,18	249,55			
41	103,04	104,40	70	176,88	178,25	99	250,73	252,10			
42	105,58	106,95	71	179,43	180,80	100	253,28	254,67			
43	108,13	109,50	72	181,98	183,35	101	255,82	257,19			
44	110,68	112,05	73	184,52	185,89	102	258,37	259,74			
45	113,22	114,59	74	187,07	188,44	103	260,91	262,28			
46	115,77	117,14	75	189,61	190,98	104	263,46	264,83			

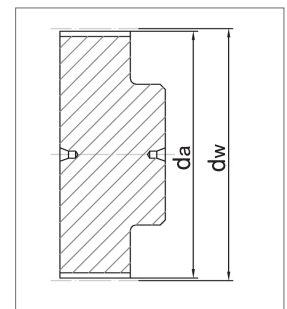

ELATECH® ECOLIFT belts

ELATECH® flat belts superior construction makes them the best solution in a wide range of lifting applications. Compared to steel cable they offer proven reliability, highly compact drives, maintenance-free operation and excellent dynamic properties.

ELATECH® flat belts are produced with a polyurethane body ensuring very high wear resistance. Steel tension cords of opposite construction (Z and S) are laid out in pairs to maximize dynamic properties. They provide excellent operational performance with low noise and vibrations and long lifetime.

Compact size and maintenance-free operation allow:

- low inertia, space savings and therefore lower manufacturing cost solutions
- lower power consumption in operation and therefore reduced running costs

In order to optimize the application in load and flexibility, ELATECH® flat belts are produced in a range of different thicknesses and steel cord diameters.

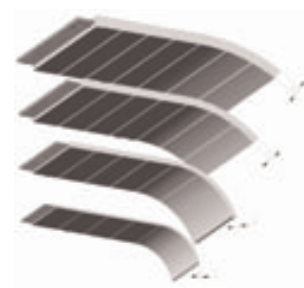

Pulley diameter depends on the type of belt and on the design load required by the application. Our catalogue reports minimum diameters for use with the maximum allowable load. For an accurate pulley diameter calculation under different load conditions please contact our technical department.

The recommended pulley geometry is cylindrical with side flanges.

Proper design of belt ends is recommended to ensure application safety. Some possible design solutions for belt end clamping are shown here as examples.

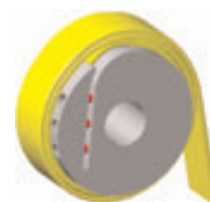
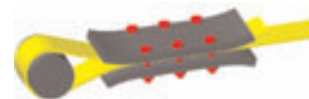

F1

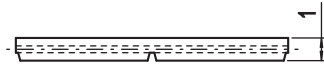

Belt characteristics

- Polyurethane flat belt with steel tension cords
- It is mainly used in lifting applications where there is no need for synchronization
- Allows the use of small diameter pulleys and compact drive design
- Black colour as standard
- Maintenance free
- Reduced thickness tolerance available on request

- Width tolerance: $\pm 0,5$ [mm]
- Thickness tolerance: $\pm 0,2$ [mm]

Technical data

Belt width b [mm]	Allowable tensile load Type M F_{Tzul} [N]	Allowable tensile load Type V F_{Tzul} [N]	Breaking load Type M F_{Br} [N]	Specific spring rate C_{spez} [N]	Weight [kg/m]
10	320	160	1250	80000	0,02
20	700	350	2750	175000	0,04
30	1090	545	4250	272500	0,05
40	1470	735	5750	367500	0,08
50	1860	930	7250	465000	0,09
100	3780	1890	14750	945000	0,21

Other widths are available on request.

Load / Elongation [%]

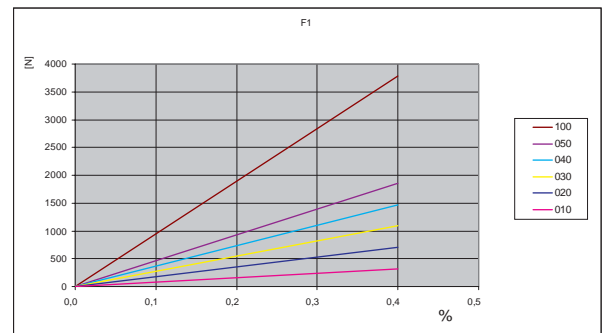

Minimum pulley diameter	Drive without reverse bending [mm]	Drive with reverse bending [mm]
	16	30

Specialties

PROFILE	Belt width b [mm]	ARAMID CORD	
		F_{Tzul} [N] M type	F_{Br} [N]
F1	010	700	2800
	020	1540	6160
	030	2380	9520
	040	3220	12880
	050	4060	16240
	100	8260	33040

F2



Belt characteristics

- Polyurethane flat belt with steel tension cords
 - It is mainly used in lifting application where there is no need for synchronization
 - Allows the use of small diameter pulleys
 - Black colour as standard
 - Maintenance free
 - Reduced thickness tolerance available on request
- Width tolerance: $\pm 0,5$ [mm]
 - Thickness tolerance: $\pm 0,2$ [mm]

Technical data

Belt width b [mm]	Allowable tensile load Type M F_{Tzul} [N]	Allowable tensile load Type V F_{Tzul} [N]	Breaking load Type M F_{Br} [N]	Specific spring rate C_{spez} [N]	Weight [kg/m]
10	1470	735	5700	367500	0,03
15	2210	1105	8550	552500	0,05
25	4170	2085	16150	1042500	0,08
30	4660	2330	18050	1165000	0,10
50	8580	4290	33250	2145000	0,17
75	12990	6495	50350	3247500	0,25
100	17400	8700	67450	4350000	0,34

Other widths are available on request.

Load / Elongation [%]

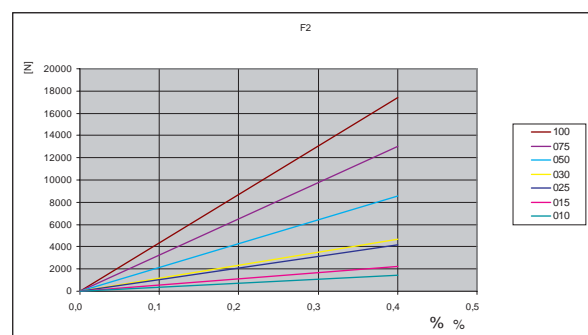

Minimum pulley diameter	Drive without reverse bending [mm]	Drive with reverse bending [mm]
	50	100

Specialties

PROFILE	Belt width b [mm]	ARAMID CORD		STAINLESS STEEL	
		F_{Tzul} [N] M type	F_{Br} [N]	F_{Tzul} [N] M type	F_{Br} [N]
F2	010	1140	4740	1080	4500
	015	1710	7110	1620	6750
	025	3230	13430	3060	12750
	030	3610	15010	3420	14250
	050	6650	27650	6300	26250
	075	10070	41870		
	100	13490	56090		

F2,5

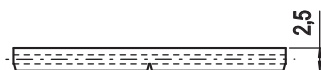

Technical data

Belt width b [mm]	Allowable tensile load Type M F_{Tzul} [N]	Allowable tensile load Type V F_{Tzul} [N]	Breaking load Type M F_{Br} [N]	Specific spring rate C_{spez} [N]	Weight [kg/m]
20	5330	2665	19444	1332500	0,08
25	6670	3335	24306	1667500	0,09
50	14400	7200	52500	3600000	0,18
75	20000	10000	72917	5000000	0,27
100	29280	14640	106750	7320000	0,36
120	34560	17280	126000	8640000	0,45

Other widths are available on request.

Minimum pulley diameter	Drive without reverse bending [mm]	Drive with reverse bending [mm]
	120	150

Belt characteristics

- Polyurethane flat belt with steel tension cords
- It is mainly used in lifting application where there is no need of synchronization
- Allows the use of small diameter pulleys
- Black colour as standard
- Maintenance free
- Reduced thickness tolerance available on request

- Width tolerance: $\pm 0,5$ [mm]
- Thickness tolerance: $\pm 0,2$ [mm]

Load / Elongation [%]

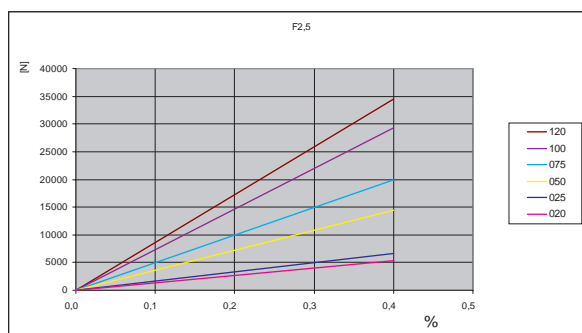

F3



Technical data

Belt width b [mm]	Allowable tensile load Type M F_{Tzul} [N]	Allowable tensile load Type V F_{Tzul} [N]	Breaking load Type M F_{Br} [N]	Specific spring rate C_{spez} [N]	Weight [kg/m]
25	6800	3400	25600	1700000	0,11
30	10200	5100	38400	2550000	0,12
60	21250	10625	80000	5312500	0,24
120	43350	21675	163200	10837500	0,48

Other widths are available on request.

Minimum pulley diameter	Drive without reverse bending [mm]	Drive with reverse bending [mm]
	120	150

Belt characteristics

- Polyurethane flat belt with steel tension cords
- It is mainly used in lifting application where there is no need of synchronization
- Allows the use of small diameter pulleys
- Black colour as standard
- Maintenance free
- Reduced thickness tolerance available on request

- Width tolerance: $\pm 0,5$ [mm]
- Thickness tolerance: $\pm 0,2$ [mm]

Load / Elongation [%]

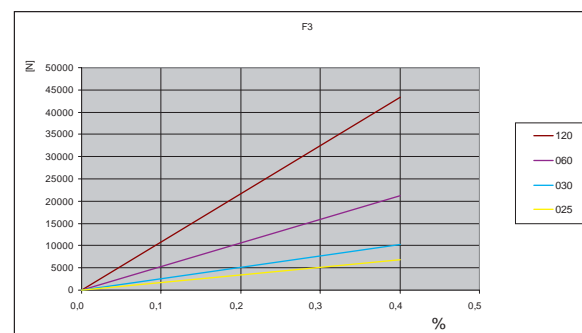

POLY-V K

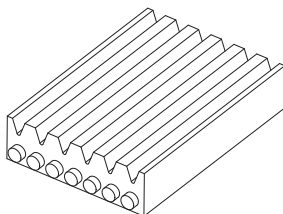
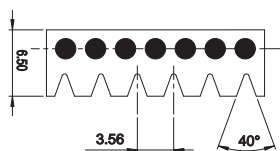

Belt characteristics

- Polyurethane Poly-V belt with K profile and high tensile load steel cords for high performance and increased flexibility
- The Poly-V profile allows torque high transmission, small pulley diameter
- Low noise generation
- Widely used in lifting applications

- Width tolerance: $\pm 1,0$ [mm]
- Thickness tolerance: $\pm 0,4$ [mm]

Technical data

Belt width b [mm]	Allowable tensile load Type M F_{Tzul} [N]	Allowable tensile load Type V F_{Tzul} [N]	Breaking load Type M F_{Br} [N]	Specific spring rate Cspez [N]	Weight [kg/m]
25	7700	3850	31500	1925000	0,35
50	17600	8800	72000	4400000	0,70
75	27500	13750	112500	6875000	1,10
100	37400	18700	153000	9350000	1,45
150	55000	27500	225000	13750000	2,20

Load / Elongation [%]

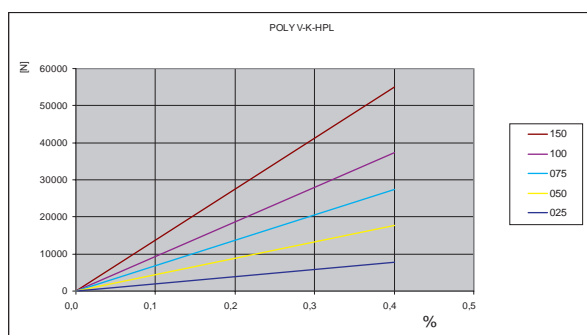

Other widths are available on request.

TT5 Polyurethane timing belts

ELATECH® manufactures special TT5 belts which have been expressly designed for application in circular knitting machines drives.

TT5

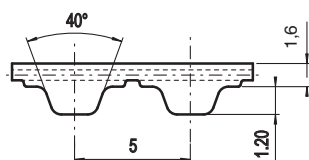

Belt characteristics

- Trapezoidal tooth profile according to DIN 7721 T1
 - Metric pitch 5 mm
 - Standard colour: blue with kevlar cords, white with steel cords, other colours available on request
 - Polyurethane 88 Sh. A
- Width tolerance: $\pm 0,5$ [mm]
 - Length tolerance: $\pm 0,5$ [mm]
 - Thickness tolerance: $\pm 0,2$ [mm]

ELATECH® belts TT5 are available in the following executions:

ELATECH® - V

- A special slicing and welding process offers superior traction load resistance.
- They are available both with steel and aramid cords.
- Special colours available on demand.
- Available in any length tooth by tooth.

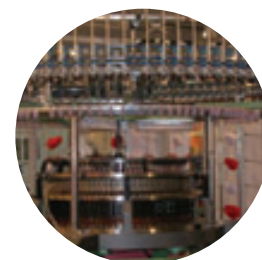

ELA-flex SD™ truly endless

- ELA-flex SD™ TT5 have no splice and welding and therefore offer best traction resistance load.
- They are available both with steel and aramid cords.
- Special colours available on demand.
- Available in all lengths tooth by tooth up to a length of 13500 mm.



Technical data

Belt width b [mm]	Allowable tensile load Type M F_{Tzul} [N]	Allowable tensile load Type V F_{Tzul} [N]	Breaking load Type M F_{Br} [N]	Weight [kg/m]
ARAMID (Kevlar) cords				
10	840	420	3360	0,019
STEEL cords				
10	380	190	1500	0,021

Minimum pulley number of teeth and minimum idler diameter			
10 TT5		TYPE OF CORD	
		ARAMID	STEEL
	Timing pulley z_{min}	12	10
	Idler running on belt teeth d_{min}	30 mm	30 mm
	Timing pulley z_{min}	15	15
	Idler running on belt back d_{min}	30 mm	30 mm

Clamp plates

Clamp plates may be used as positive attachment of the belt ends in numerous applications in linear drives. Clamp plates must have the correct belt profile, guarantee a uniform clamping force on all the clamped belt surface and must be rigid.

For standard applications a minimum of 8 teeth in clamp is recommended.

For use with timing belts with HPL cords, a minimum of 12 teeth in clamp is recommended.

EAGLE™ clamp plates are available as semi finished product. Standard material for clamp plates is aluminium.

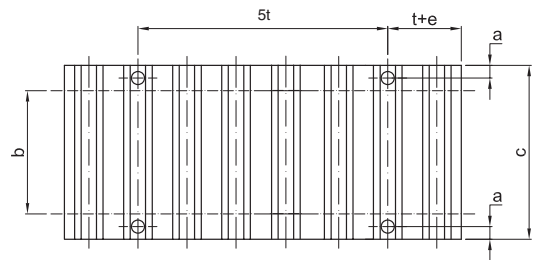
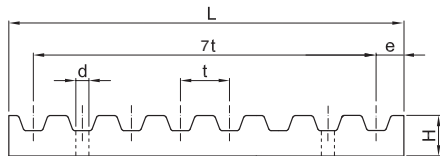

Type	a (mm)	d (mm)	e (mm)	L (mm)	H (mm)	Belt width b (mm)							
						6	10	16	25	32	50	75	100
C													
T5	6	5,5	3,2	41,8	8	-	29	35	44	-	-	-	-
AT5	6	5,5	3,2	41,8	8	-	29	35	44	-	-	-	-
T10	8	9	5	80	15	-	-	41	50	57	75	100	125
AT10	8	9	5	80	15	-	-	41	50	57	75	100	125
T20	10	11	10	160	20	-	-	-	56	63	81	106	132
AT20	10	11	10	160	20	-	-	-	56	63	81	106	132

Type	a (mm)	d (mm)	e (mm)	L (mm)	H (mm)	Belt width b (inch/100)							
						025	031	037	050	075	100	150	200
C													
XL	6	5,5	3,5	42,5	8	25,5	27	28,5	-	-	-	-	-
L	8	9	6	76,6	15	-	-	36	39	45	51,5	64	77
H	10	11	9	106,9	22	-	-	-	45	51	57,5	70	83

Type	a (mm)	d (mm)	e (mm)	L (mm)	H (mm)	Belt width b (mm)								
						15	20	25	30	40	50	55	85	115
C														
5M	6	5,5	3,4	41,8	8	34	-	44	-	-	-	-	-	-
8M	8	9	5	66	15	40	45	-	55	-	75	-	110	-
14M	10	11	9	116	22	-	-	56	-	71	-	86	116	146

Pitch t	a (mm)	d (mm)	e (mm)	L (mm)	H (mm)
EAGLE 8M	8	9	5	74	15
EAGLE 14M	10	11	9	130	22

Belt Width (mm)							
16	25	32	50	35	52,5	70	105
Plate Width C (mm)							
41	50	57	75	-	-	-	-
-	-	-	-	66	83,5	101	136

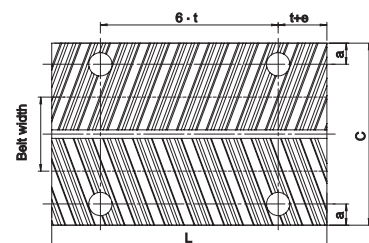
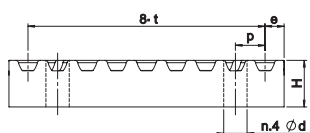

Drive calculation

GUIDELINES

Pulleys

It is recommended to use pulleys with the maximum diameter allowed by the application in order to maximise the number of teeth in mesh and increase the belt peripheral speed. For applications where high positioning precision is required, it might be useful to use zero backlash pulleys.

In order to guarantee a reliable drive, it is recommended to use superior quality pulleys

Machine structure

For a trouble free drive, it is recommended that the structure of application of the timing belt drive, is as rigid as possible. That will guarantee high work repeatability.

Clamping plates

In case of use of clamping plates, they must have the belt profile, be rigid and guarantee a uniform clamping force on all the surface. It is recommended to have a minimum of 8 teeth in clamp to guarantee catalogue performances. In case of belts with HPL cords, the recommended number of teeth in clamp is 12.

DEFINITIONS AND TRANSMISSION CYCLE

In most cases linear drives may be taken back to one of the two layouts shown, where a specific system of forces acts.

“ OMEGA “ drive

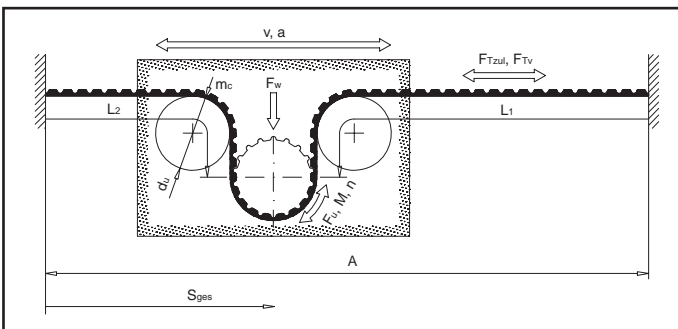

Linear drive

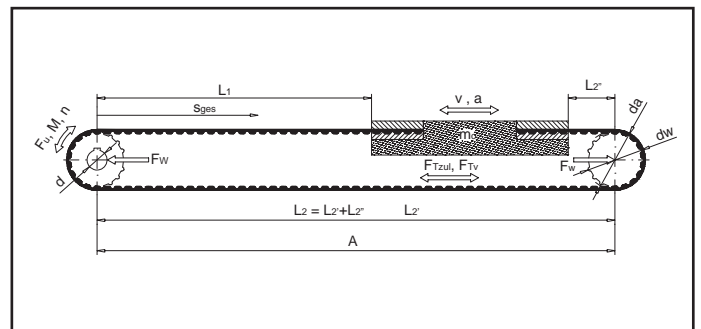

Transmission cycle (rpm/time)

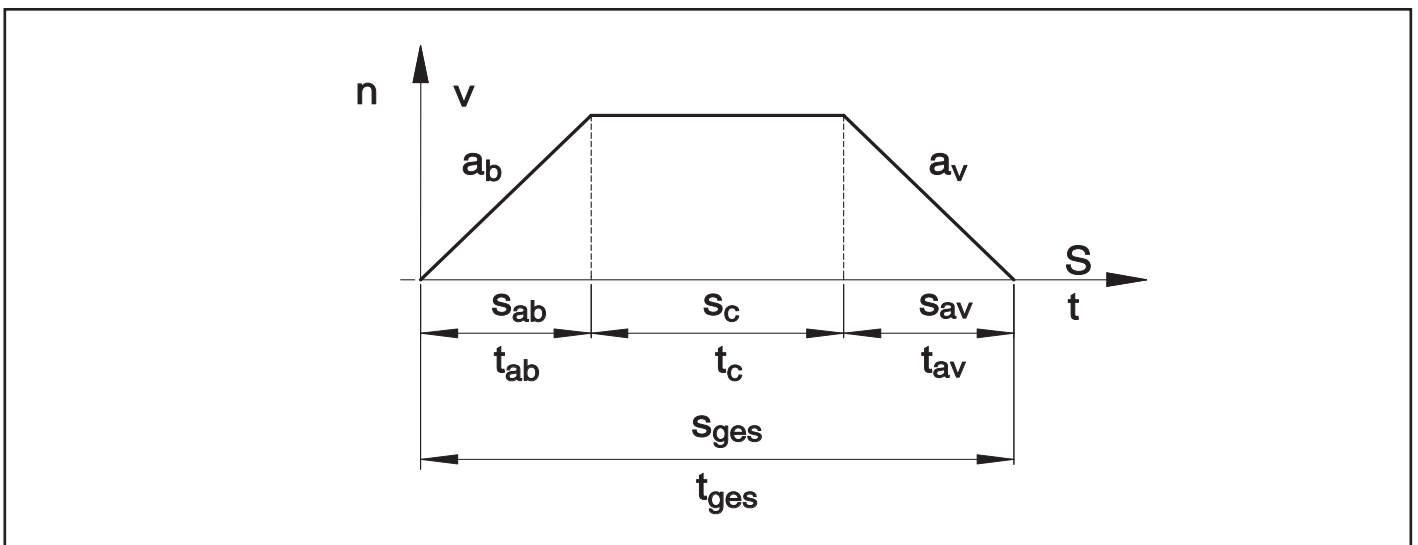

Definitions and abbreviations

a_b	(m/s ²)	Acceleration	M_{av}	(Nm)	Braking torque
a_v	(m/s ²)	Deceleration	ρ	(kg/dm ³)	Specific weight
B	(mm)	Pulley width	m	(kg)	Total mass
b	(cm)	Belt width	m_R	(kg)	Mass of belt
t	(mm)	Belt pitch	m_c	(kg)	Mass of carriage / slide
C	(N/mm)	Belt modulus / spring rate	m_S	(kg)	Pulley mass
C_{spez}	(N)	Specific spring rate	m_{Sred}	(kg)	Pulley reduced mass
A	(mm)	Centre distance	m_U	(kg)	Idler mass
A_{eff}	(mm)	Effective centre distance	m_{Ured}	(kg)	Idler reduced mass
d	(mm)	Bore diameter	n	(min ⁻¹)	Rpm
d_a	(mm)	Outside pulley diameter	n_1	(min ⁻¹)	Rpm driver pulley
d_w	(mm)	Pitch circle diameter	Δn	(min ⁻¹)	Rpm variation
d_U	(mm)	Idler pulley diameter	c_1	-	Service factor
F_{wdyn}	(N)	Dynamic shaft load	P	(kW)	Power
F_{wsta}	(N)	Static shaft load	s_{ges}	(mm)	Total travel
F_{Tmax}	(N)	Maximum span force	s_{ab}	(mm)	Travel during acceleration
F_R	(N)	Resisting force of friction	s_{av}	(mm)	Travel during deceleration / braking
F_{Uspez}	(N/cm)	Specific tooth shear strength	s_c	(mm)	Travel at constant speed
F_{TV}	(N)	Pretension force per belt side	t_{ges}	(sec ⁻¹)	Total time of travel
F_{Tzul}	(N)	Allowable tensile load	t_{ab}	(sec ⁻¹)	Acceleration time
F_U	(N)	Peripheral force	t_{av}	(sec ⁻¹)	Deceleration time / braking time
F_H	(N)	Vertical lifting force	t_c	(sec ⁻¹)	Time at constant speed
F_{ab}	(N)	Acceleration force	v	(m/s)	Peripheral speed
F_{av}	(N)	Deceleration force	z	-	No. of teeth of pulley
g	(m/s ²)	Acceleration due to gravity (= 9,81 m/s ²)	z_k	-	No. of teeth of small pulley
Δl	(mm)	Elongation	z_g	-	No. of teeth of big pulley
Δs	(mm)	Difference of position due to force	z_R	-	No. of teeth of belt
L_1, L_2	(mm)	Length of tight and slack side	z_e	-	No. of teeth in mesh
L_R	(mm)	Belt length	i	-	Drive ratio
M	(Nm)	Torque	ω	(s ⁻¹)	Angular velocity
M_{ab}	(Nm)	Torque during acceleration	μ	-	Coefficient of friction

Calculation formula

Torque

$$M = \frac{F_U \cdot d_W}{2000} = \frac{P \cdot 9550}{2000}$$

Peripheral force

$$F_U = \frac{2000 \cdot M}{d_W} = \frac{P \cdot 1000}{v}$$

Angular velocity

$$\omega = \frac{\pi \cdot n}{30}$$

Acceleration time

$$t_{ab} = \frac{v}{a_b} = \sqrt{\frac{2 \cdot s_{ab}}{a_b \cdot 1000}}$$

Braking time

$$t_{av} = \frac{v}{a_v} = \sqrt{\frac{2 \cdot s_{av}}{a_v \cdot 1000}}$$

Total time

$$t_{ges} = t_{ab} + t_c + t_{av}$$

Time at constant speed

$$t_c = \frac{s_c}{v \cdot 1000}$$

Safety factor

ELATECH® belts do not need any safety factor. However if there are unknown peaks or shock loads or swings in the peripheral force unknown at design time, which therefore can not be included in the calculation parameters, a suitable safety factor should be considered by the designer.

Steady load $c_1 = 1$

Peak or fluctuating loads:

Light	$c_1 = 1,4$
Medium	$c_1 = 1,7$
Heavy	$c_1 = 2,0$

Power

$$P = \frac{M \cdot n}{9550} = \frac{F_U \cdot v}{1000}$$

Linear speed

$$v = \frac{d_W \cdot n}{19100} = \frac{n \cdot z \cdot t}{60000}$$

Rpm

$$n = \frac{19100 \cdot v}{d_W} = \frac{60000 \cdot v}{z \cdot t}$$

Acceleration travel

$$s_{ab} = \frac{a_b \cdot t_{ab}^2 \cdot 1000}{2} = \frac{v^2 \cdot 1000}{2 \cdot a_b}$$

Braking travel

$$s_{av} = \frac{a_v \cdot t_{av}^2 \cdot 1000}{2} = \frac{v^2 \cdot 1000}{2 \cdot a_v}$$

Total travel

$$s_{ges} = s_{ab} + s_c + s_{av}$$

Travel at constant speed

$$s_c = v \cdot t_c \cdot 1000$$

Calculation

Linear drives are correctly dimensioned when the total peripheral force, necessary for the requested work, satisfies the 3 technical parameters of the selected belt:

- **tooth shear strength**
- **allowable tensile load**
- **flexibility**

The necessary data for the calculation are: the mass to be moved, the transmission cycle, the drive layout with the related forces, the resisting force of friction.

Friction force is generally determined by the linear bearing manufacturer.

In case of conveying applications, it is resulting from the weight of the conveyed goods and the coefficient of friction between slider bed and belt surface. In case of accumulating conveyors the friction between the conveyed goods and the backside of the belt must be considered additionally.

Select belts and pulleys

For initial belt profile and pitch selection, use the graphs available in the related catalogue section.

For the choice of the pulleys it is recommended to use pulleys with the largest possible diameter.

That will reduce the belt width and optimise drive performances.

Calculate total mass in motion (m)

$$m = m_c + m_R + m_{Sred} + m_{Ured}$$

With:

$$m_{Sred} = \frac{m_s}{2} \cdot \left(1 + \frac{d^2}{d_a^2}\right); \quad \text{inertia of the idler timing pulley}$$

$$m_{Ured} = \frac{m_U}{2} \cdot \left(1 + \frac{d^2}{d_u^2}\right); \quad \text{inertia of the idler tensioning pulley}$$

Calculate the necessary total peripheral force F_U and torque M

$$F_U = m \cdot a_b + m \cdot g + m \cdot g \cdot \mu$$

$$F_U = F_{ab} + F_H + F_R$$

The load ($m \cdot g \cdot \sin\alpha$) must be considered only in vertical or inclined drives when a mass is lifted against gravity.

$$M = \frac{F_U \cdot d_w}{2000}$$

Determine the belt width

$$b = \frac{F_U \cdot C_1}{F_{Uspez} \cdot Z_e}$$

with F_{Uspez} depending on the rpm of the small pulley (see technical data on tooth shear strength for the selected belt type).

Note: $Z_{emax} = 12$ for belts ELATECH® M

$Z_{emax} = 6$ for belts ELATECH® V

Determine installation pretension F_{TV}

Linear motion drives are correctly tensioned when in the slack side a minimum tension is guaranteed in all working conditions and for every value of F_{Tmax} (acceleration, deceleration).

It is recommended a pretension of:

$F_{TV} \geq F_U$ for linear drives with ELATECH® M belts

$F_{TV} \geq 0,5 \cdot F_U$ for conveying applications with ELATECH® V belts

Verify of allowable tensile load

The maximum load on the belt will appear when both the pretension F_{TV} and the working load F_U will act at the same time:

$$F_{Tmax} = F_{TV} + F_U$$

The maximum allowable tensile load of the belt F_{Tzul} (see technical tables of corresponding selected belt) must be greater than the maximum working load:

$$F_{Tzul} > F_{Tmax}$$

Verify flexibility

The diameter of the chosen pulleys, must be greater or equal to the minimum recommended diameter for the specific belt profile chosen (see technical data).

Calculate shaft load

The shaft load under static conditions is:

$$F_{Wsta} = 2 \cdot F_{TV}$$

The shaft load under dynamic conditions is:

$$F_{Wdyn} = 2 \cdot F_{TV} + F_U$$

Calculate necessary static elongation

Installation tension generates a belt elongation "Δl" between the shafts (for linear drives) or the clamping plates (for "Omega" drives).

Linear drive

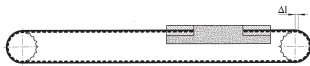

$$\Delta l = \frac{F_{TV} \cdot L_R}{2 \cdot C_{spez}}$$

"Omega" drive

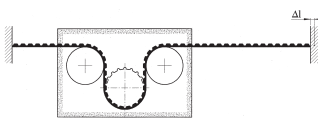

$$\Delta l = \frac{F_{TV} \cdot L_R}{C_{spez}}$$

If the resulting elongation is not acceptable for the application, it is possible to reduce it by increasing the belt width.

Determine the positioning accuracy

The stiffness coefficient of linear drives depends on the length of slack and tight side in the drive. Every position of the system has its own stiffness coefficient calculated with the formula:

$$C = \frac{L_R}{L_1 \cdot L_2} \cdot C_{spez} \quad L_R = L_1 + L_2$$

For C_{spez} value see technical data of selected belt type.

Stiffness coefficient will be minimum when slack and tight side will have the same length during the working cycle.

$$C_{min} = \frac{4 \cdot C_{spez}}{L_R}$$

With L_R equal to the belt length free to elongate (excluding contact length on timing pulleys).

Being F_U the resulting force on the slide, the positioning deviation generated by belt elongation is:

$$\Delta_s = \frac{F_U}{C}$$

The positioning accuracy is also depending on other parameters and therefore for an accurate calculation, please consult our technical department.

Installation and drive pretensioning:

In order to pretension a drive is possible to use one of the following methods:

1) Measuring elongation

ELATECH® timing belts with steel cords have a constant elongation to the maximum allowable load F_{Tzul} . Therefore the correct pretension can be set by measuring the belt elongation with a gauge and using as a reference the graph load/elongation of the selected belt type. This is a simple method but requires a good accessibility of the drive.

2) Using span deflection

The pretension is checked by applying a force in the centre of the span length and measuring the span deflection

3) Measuring frequency

The tension of the belt is calculated from the natural frequency of vibration of the belt span which is measured by means of a special belt tension meter. This is the most accurate and easiest method.

A suitable belt tension meter is available from ELATECH®

Calculation example

Linear positioning drive

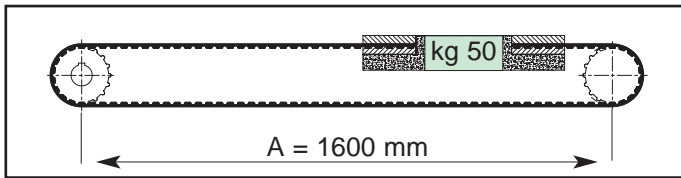

Data

Slide mass	$m_c = 50$ [kg]
Center distance	$A = 1600$ [mm]
Acceleration	$a_b = 20$ [m/s ²]
Maximum allowable pulley diameter	$d_w = 110$ [mm]
Friction force	$F_R = 100$ [N]
Total travel	$s_{ges} = 1100$ [mm]
Linear speed	$v = 5$ [m/s]
Shaft diameter	$d = 28$ [mm]

Select belt

From selection graph mass/acceleration of AT belts (preferred for linear positioning because of the higher stiffness) select a 25 AT10 belt with aluminium pulleys $z = 32$ ($d_a=100,00$ mm and $d_w=101,86$ mm).

$$\text{Rpm} \quad n = \frac{19100 \cdot 5}{101,86} = 937,56$$

Calculation of total mass in motion

$$L_R = L_1 + L_2 = 1600 \cdot 2 = 3200 \text{ mm}$$

Belt mass m_R :

$$m_R = 3,2 \cdot 0,15 = 0,48 \text{ kg}$$

Pulley mass m_S :

$$\frac{(d_a^2 - d^2) \cdot \pi \cdot \rho \cdot B}{4 \cdot 10^6} = \frac{(100^2 - 28^2) \cdot \pi \cdot 2,8 \cdot 30}{4 \cdot 10^6} = 0,61 \text{ kg}$$

Reduced pulley mass m_{Sred} :

$$\frac{m_S}{2} \cdot \left(1 + \frac{d^2}{d_a^2}\right) = \frac{0,61}{2} \cdot \left(1 + \frac{28^2}{100^2}\right) = 0,33 \text{ kg}$$

$$m = m_c + m_R + m_{Sred} = 50 + 0,48 + 0,33 = 50,81 \text{ kg}$$

Calculate total peripheral force F_U

$$F_U = m \cdot a_b + F_R = 1116,2 \text{ N}$$

$$M = \frac{1116,2 \cdot 101,86}{2000} = 56,85 \text{ Nm}$$

Check belt width

$$b = \frac{1116,2}{52,21 \cdot 12} = 1,78 \text{ cm} \approx 18 \text{ mm}$$

A belt width 25 mm is selected as next standard width.

Determine effective installation tension F_{TV}

$$F_{TV} > F_U = 1116,2 \text{ N} ; \quad \text{choose } F_{TV} = 1200 \text{ N}$$

Verify allowable tensile load

$$F_{Tmax} = F_{TV} + F_U = 2316,2 \text{ N}$$

$$F_{Tzul} > F_{Tmax} \quad 4170 \text{ N} > 2316,2 \text{ N}$$

Determine necessary elongation

$$\Delta l = \frac{1200 \cdot 3200}{2 \cdot 952000} = 2,02 \text{ mm} \approx 0,63 \text{ ‰}$$

Should the elongation be too high, a larger width must be selected or ATL10 type of the same width can be used.

Check flexibility

The minimum pulleys diameter are respected.

Selection graphs mass / acceleration

The selection graphs **mass/acceleration**, are a useful aid to the designer for the initial selection of the belt type and width in the linear motion applications. The graphs have been designed considering the maximum speed (rpm) generally used in the applications for every belt profile and pitch and have included a safety factor increasing with the acceleration. Therefore, depending on the specific values of the application, it might be needed to change the belt width upon calculation.

T2,5

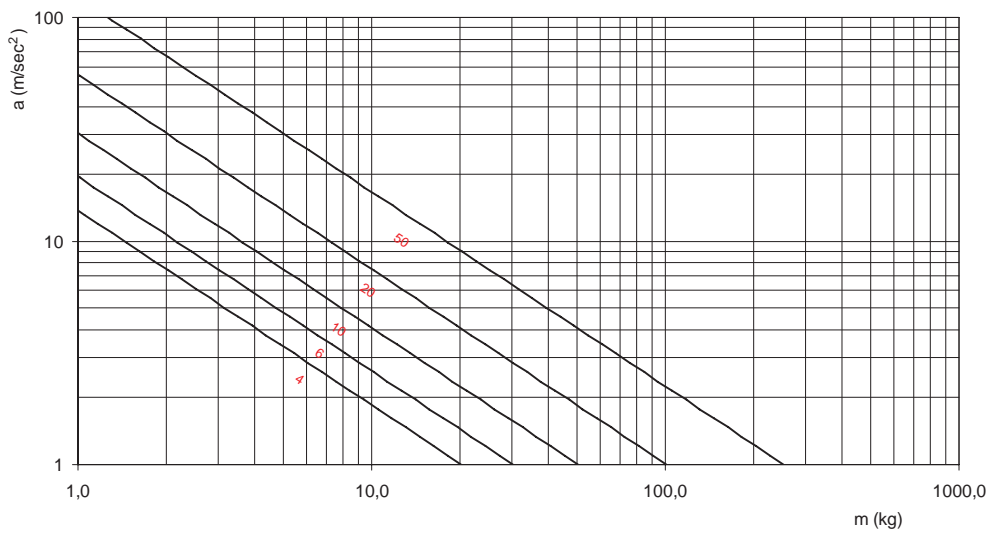

T5

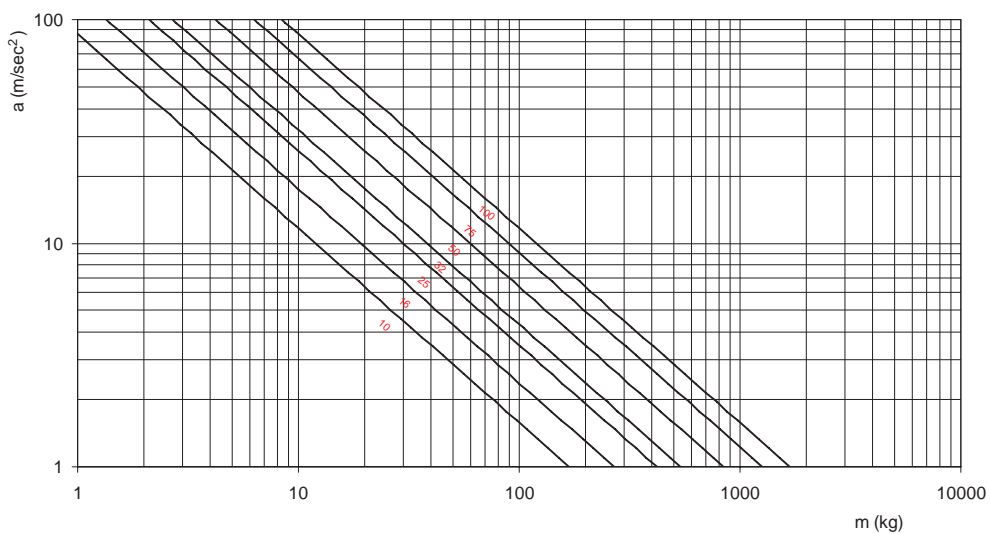

T10

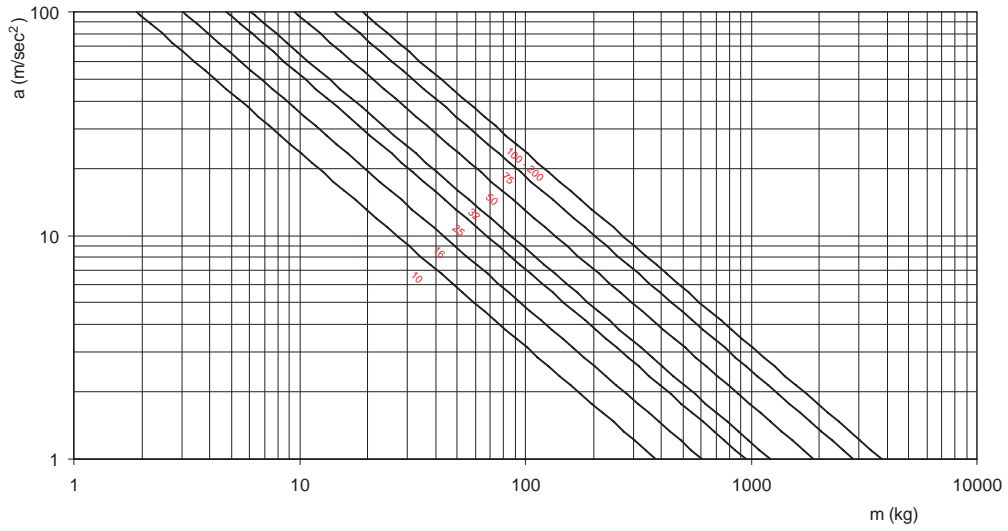

T20

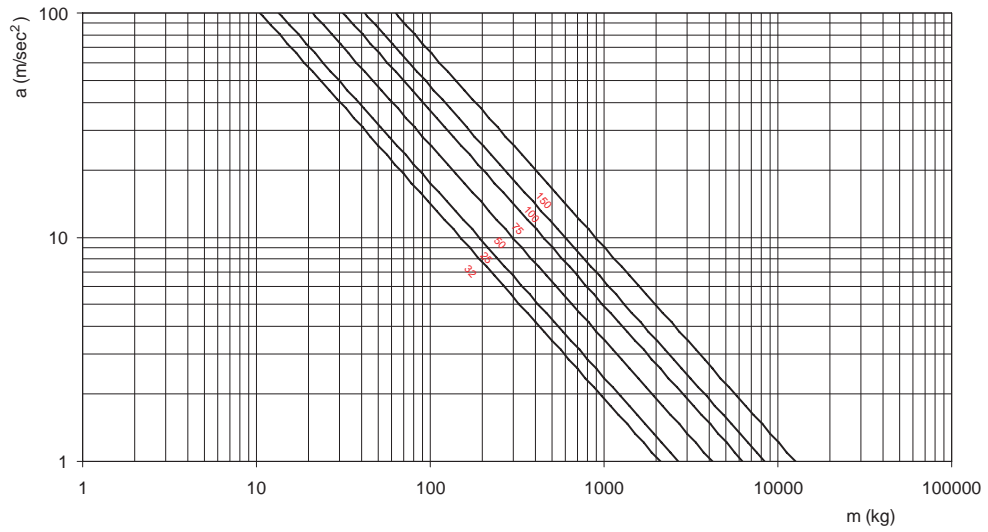

AT5 - ATL5

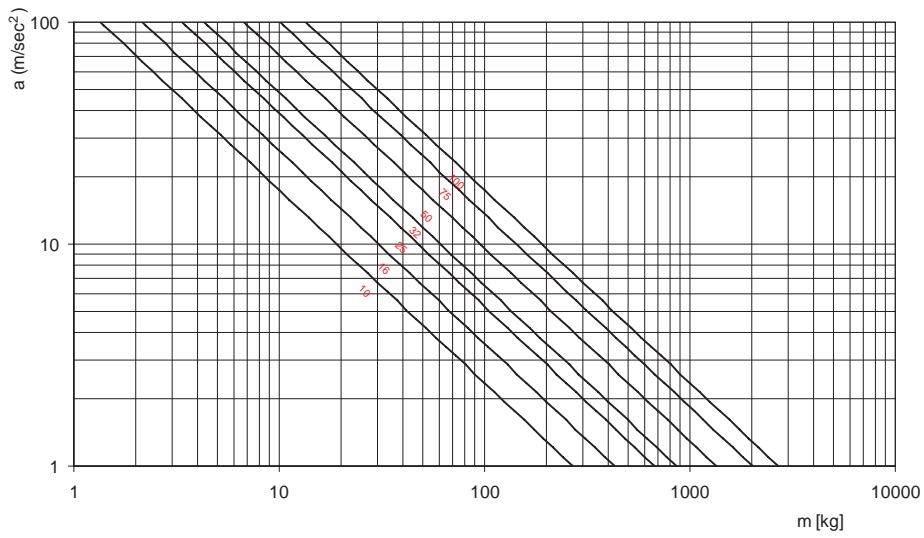

AT10 - ATL10

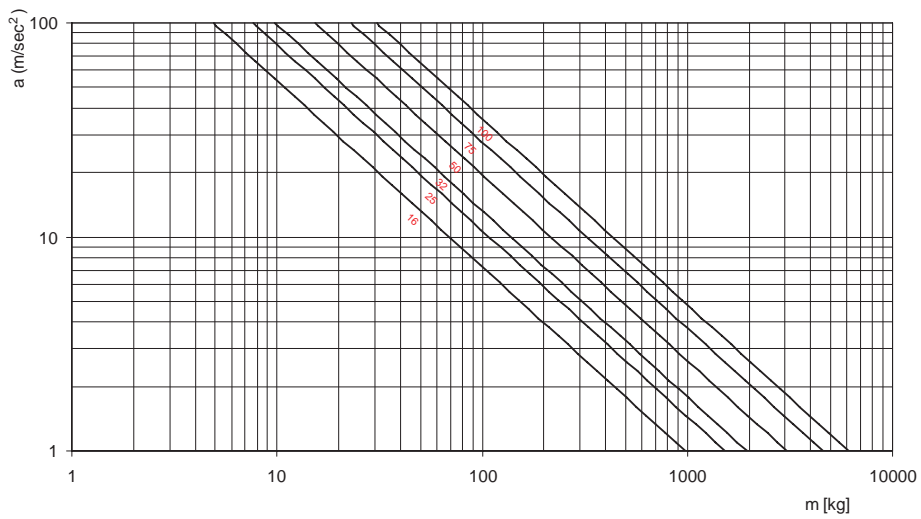

AT20 - ATL20

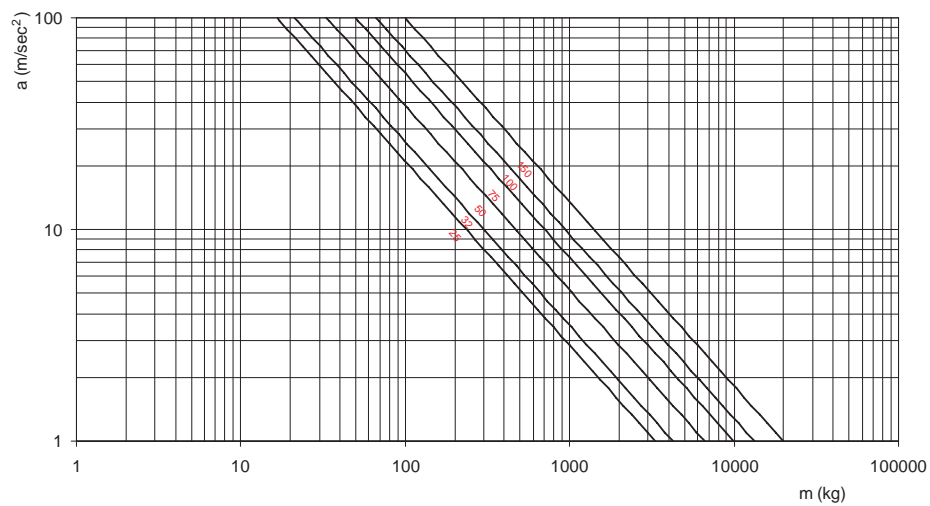

XL

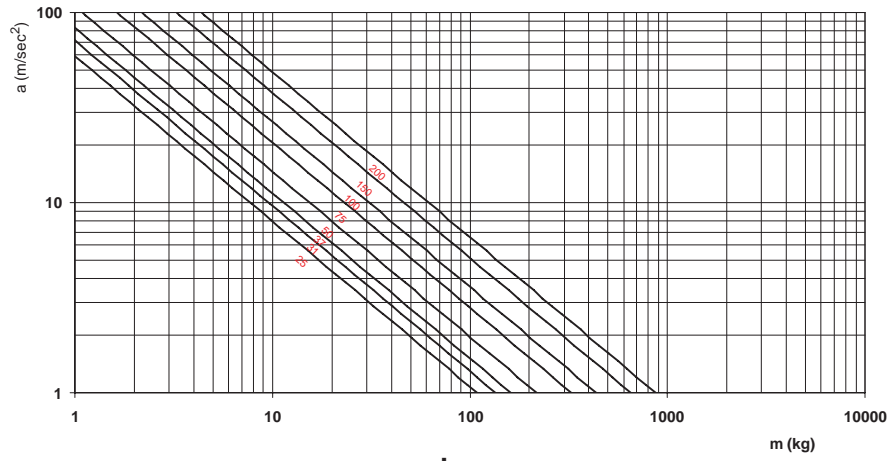

L

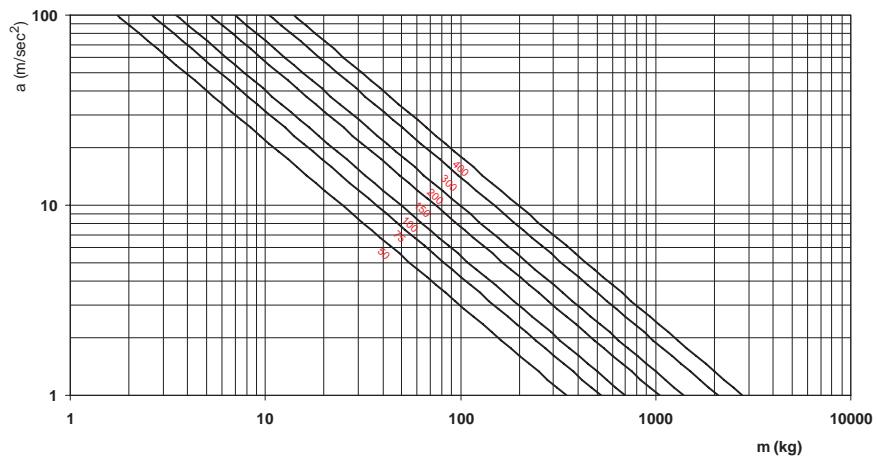

H

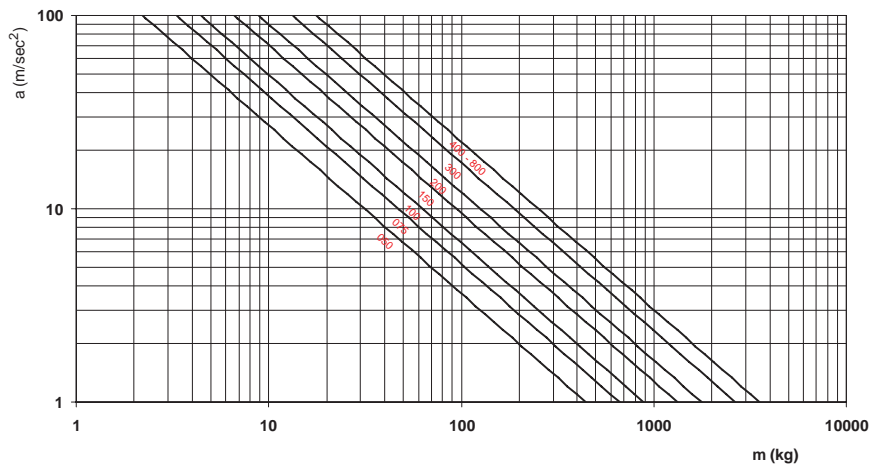

XH

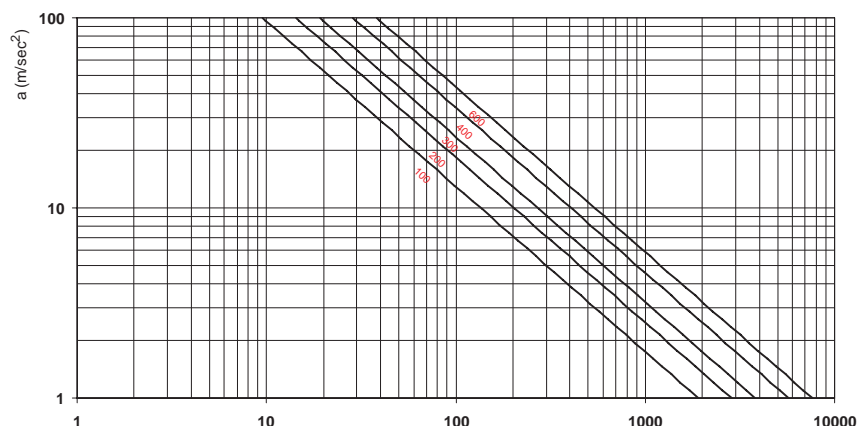

HTD3M

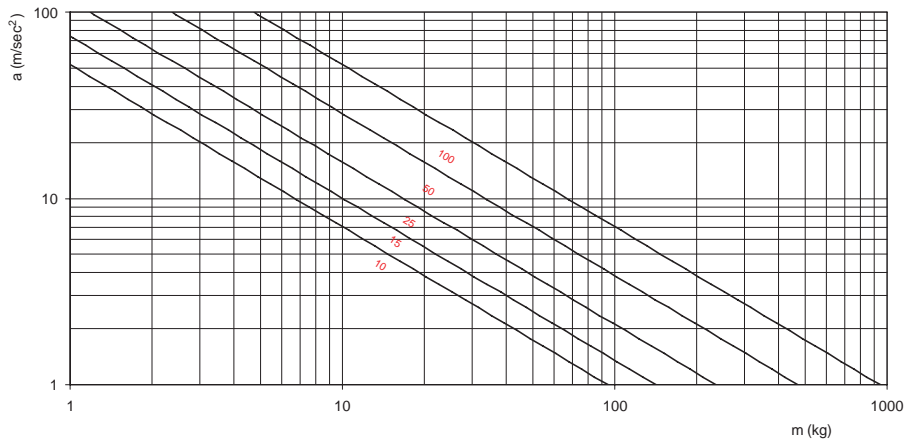

HTD5M

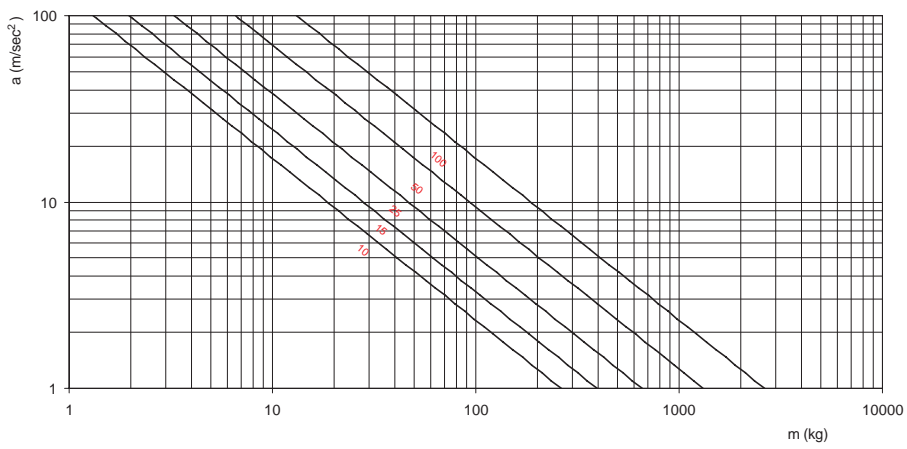

HTD8M

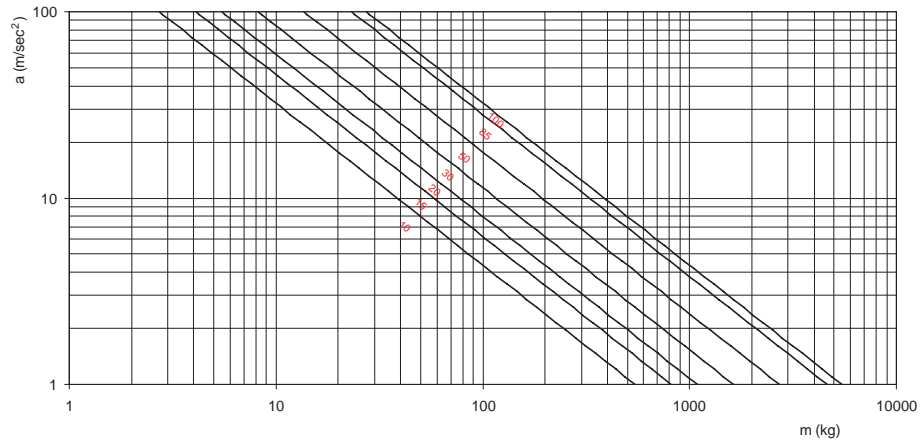

HTD14M

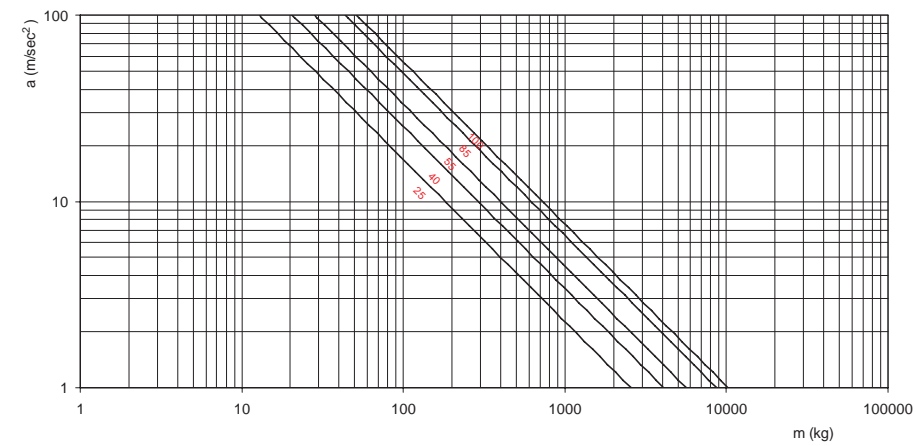

RTD5M

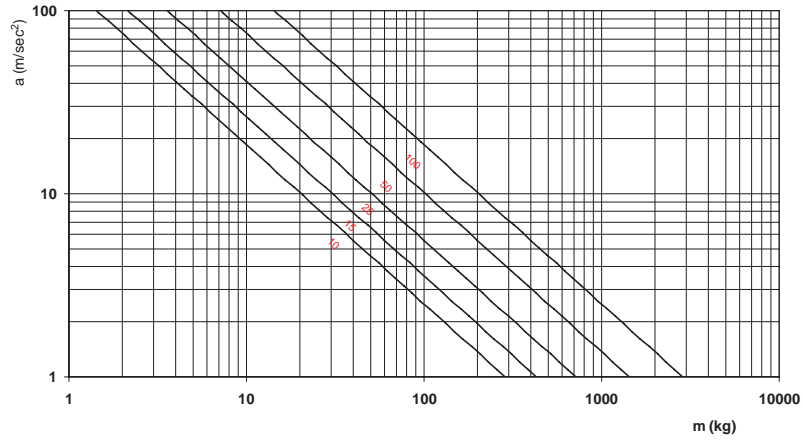

RTD8M

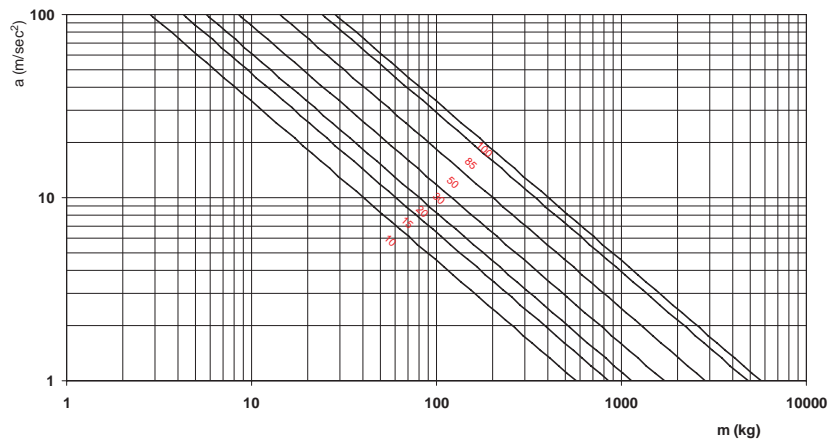

RTD14M

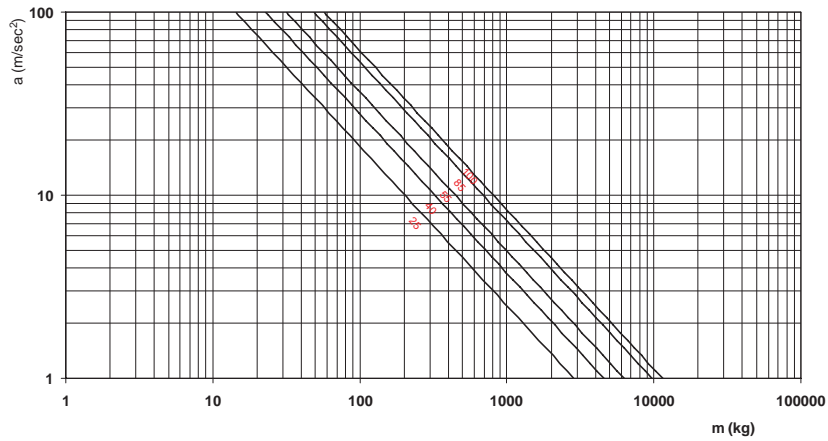

STD5M

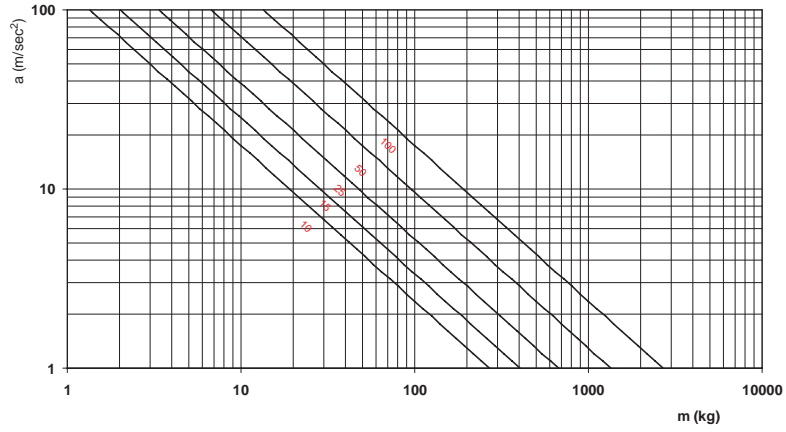

STD8M

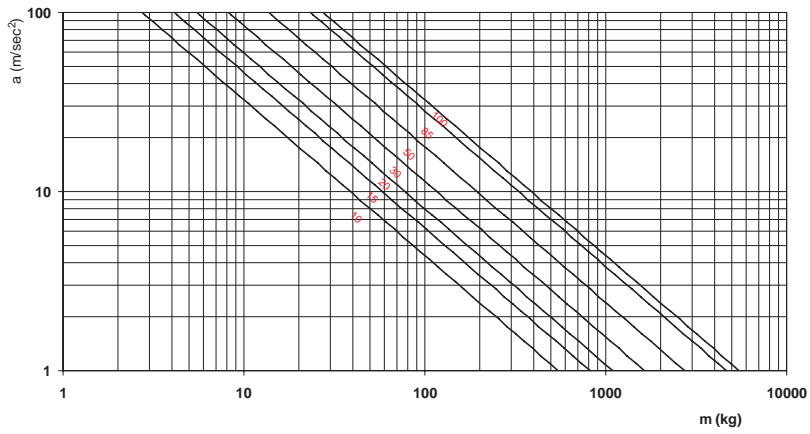

STD14M

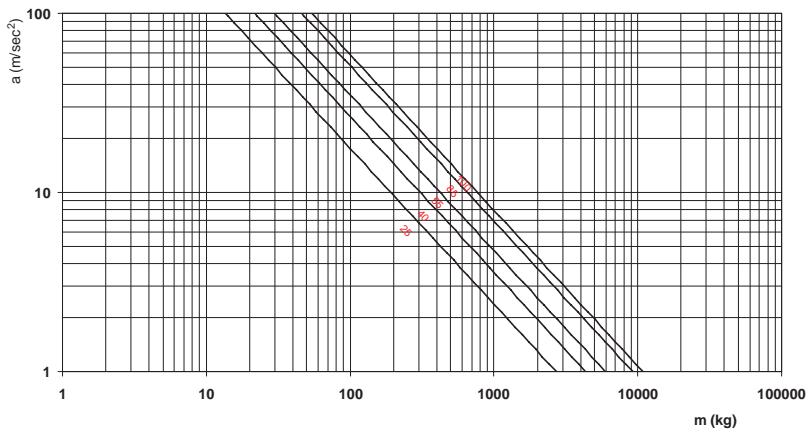

EAGLE 8M

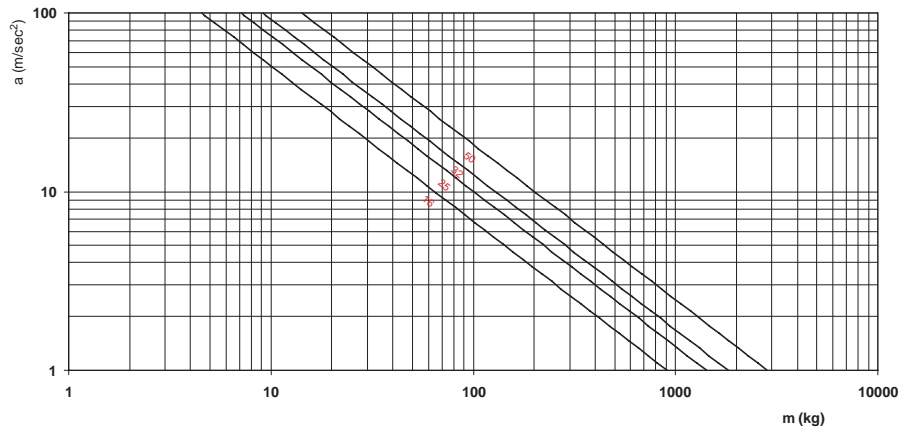

EAGLE 14M

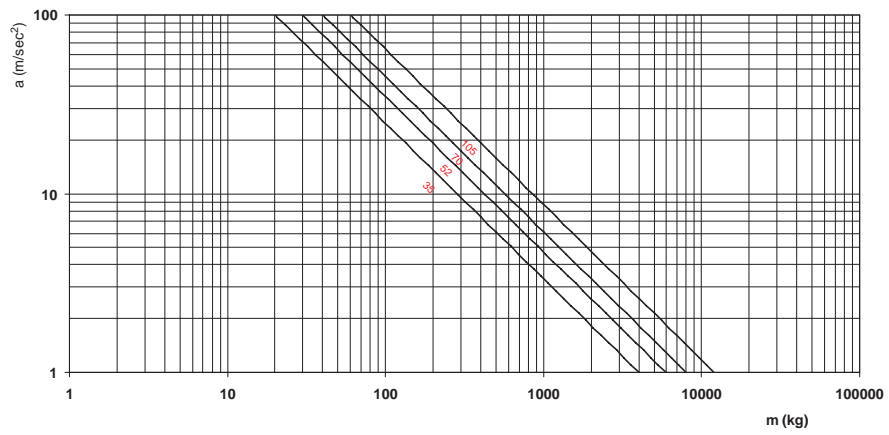

Selection graphs corrected peripheral force / belt width

The selection graphs **corrected peripheral force / belt width** provide a quick indication on the belt width needed for each belt profile when a specific corrected load is applied. The graphs have been designed considering the maximum speed (rpm) generally used in the applications for every belt profile and pitch. No safety factor is included as usually depending on acceleration. Therefore, depending on the specific values of the application, it might be needed to change the belt width upon calculation.

T profile

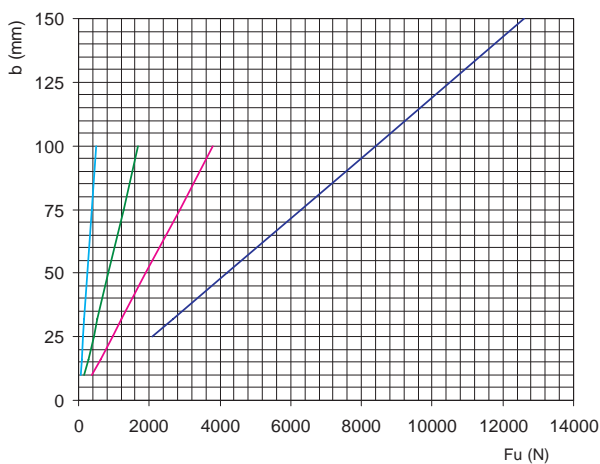

AT profile

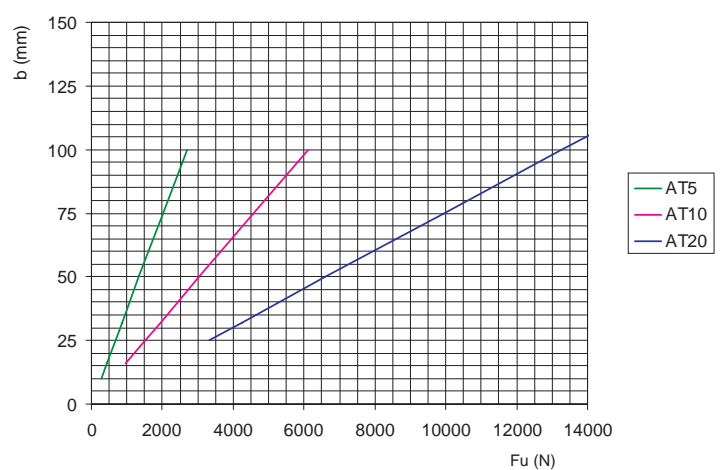

Inches Profile

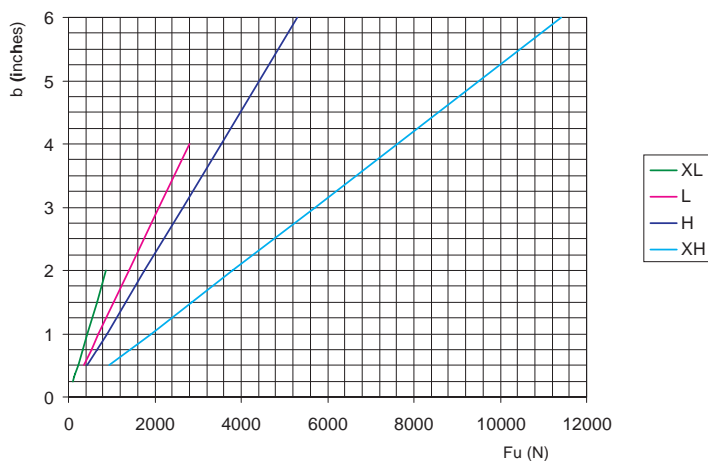

HTD profile

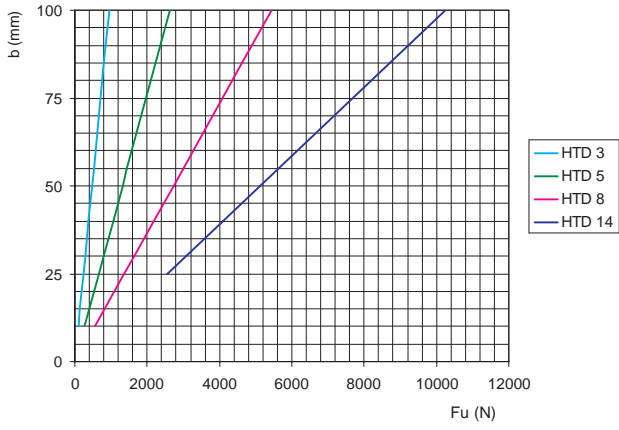

RTD profile

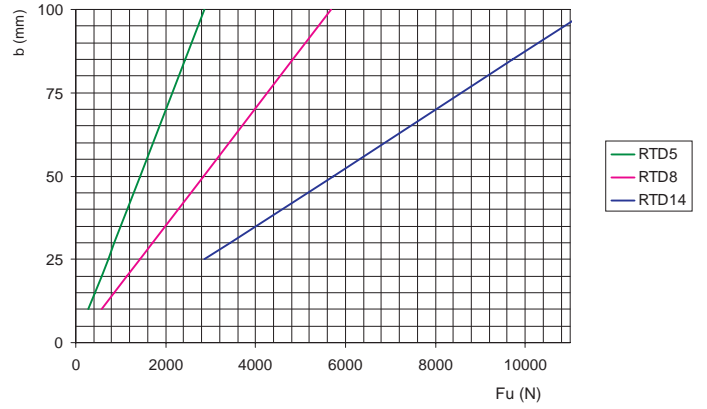

STD profile

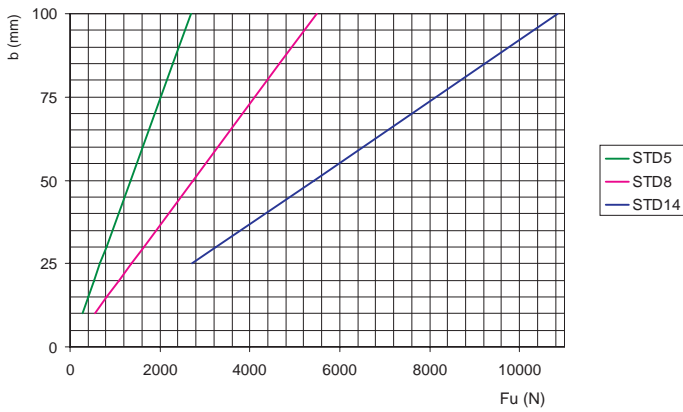

EAGLE profile

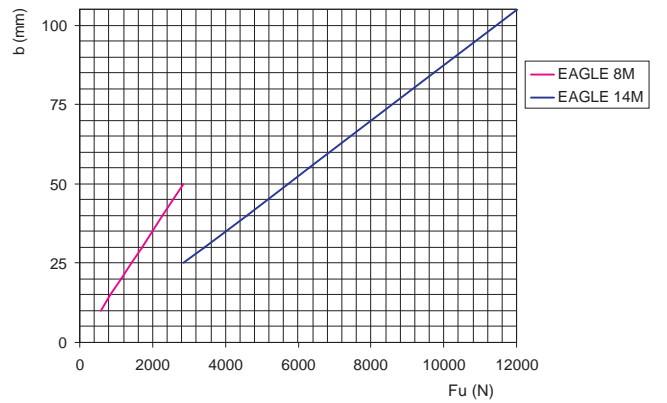

ELA-flex SD™ timing belts



ELA-flex SD™ Synchro Drive timing belts

ELA-flex SD™ timing belts are manufactured with truly endless high tension strength steel tension cords and high wear, abrasion and tear resistance polyurethane.

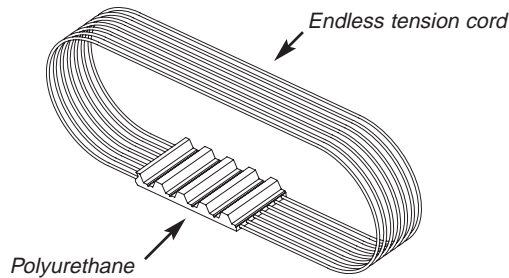

Having no splice or welding, the belts have no weak cross section. ELA-flex SD™ timing belts are therefore ideal for high speed power transmission and high load conveying applications.

The unique high tech manufacturing process designed by our research and development allows the production of every belt length, tooth by tooth from a minimum of 1500 mm to a maximum of 22000 mm to permit the best flexibility in application.

Length tolerances

Belt length [mm]	Length tolerance [mm] (+/-)	Belt length [mm]	Length tolerance [mm] (+/-)
1700	1,13	4500	2,32
1900	1,22	4750	2,40
2120	1,30	5000	2,52
2240	1,35	5300	2,64
2360	1,44	5600	2,72
2500	1,49	6000	2,92
2650	1,57	6300	3,04
2800	1,61	6700	3,19
3000	1,70	7100	3,35
3550	1,91	7500	3,51
3750	2,03	8000	3,70
4000	2,11	9000	4,09
4250	2,24	more	on request

Double sided timing belts

On demand it is possible to supply ELA-flex SD™ as double sided belts. Please ask for the minimum quantity.

Special cords

In order to solve any design need, ELA-flex SD™ belts may be produced with special cords:

- HPL** high performance
- HFE** high Flexibility
- INOX** stainless steel for high aggressive environments
- ARAMID** low weight, non magnetic

Antistatic belts

On request it is possible to deliver ELA-flex™ SD™ belts with anti-static properties by using a specific electrically conductive coating or a special compound. A minimum quantity is applied.

Product certification

- ELATECH® belts are certified to be according RoHS 2002/95/EC
- On request, it is possible to deliver belts according to:
 - 94/9/CE ATEX II2G-22D
 - Antistatic according to ISO 9563 (with special fabric)

Thickness and width tolerance

ELA-flex SD™ belts are ground on the back as a standard and are manufactured at precise width (see technical tables). For special application needs, special thickness and width tolerances can be produced.

Belt designation

Metric pitch

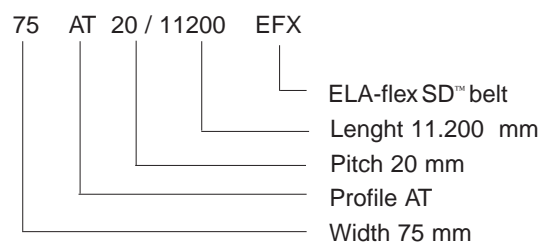

Inch pitch

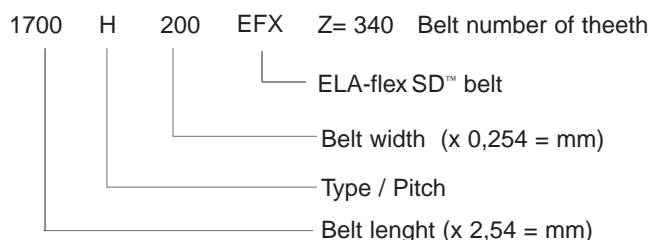

T5 ELA-flex SD™

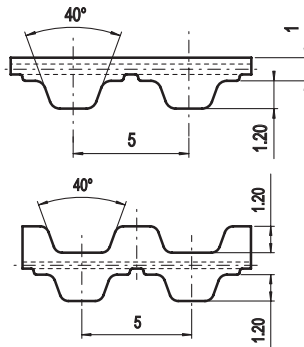
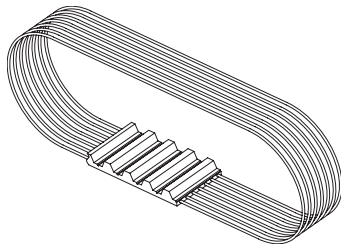

Belt characteristics

- Truly endless polyurethane timing belt with steel tension cords according to DIN 7721 T1
 - Metric pitch 5 mm
 - Ideal for drives where high belt flexibility is requested
 - Allows to use small diameter pulleys
 - Transmissible power up to 5 kW
 - Rpm up to 10.000 [1/min]
- Maximum width: 150 mm
 - Width tolerance: ±0,5 [mm]
 - Thickness tolerance: ±0,2 [mm]

Technical data

Belt width [mm]	10	16	25	32	50	75	100	150
Allowable tensile load [N]	337	540	843	1080	1687	2531	3375	5062
Weight [kg/m]	0,02	0,03	0,05	0,07	0,11	0,16	0,21	0,32

Other widths are available on request

Tooth shear strength

rpm [min ⁻¹]	M _{spez} [Ncm/cm]	P _{spez} [W/cm]	rpm [min ⁻¹]	M _{spez} [Ncm/cm]	P _{spez} [W/cm]	rpm [min ⁻¹]	M _{spez} [Ncm/cm]	P _{spez} [W/cm]
0	1,966	0,000	1200	1,252	1,573	3400	0,972	3,462
20	1,915	0,040	1300	1,231	1,676	3600	0,957	3,609
40	1,872	0,078	1400	1,211	1,776	3800	0,942	3,749
60	1,834	0,115	1440	1,204	1,815	4000	0,928	3,886
80	1,802	0,151	1500	1,194	1,875	4500	0,895	4,218
100	1,773	0,186	1600	1,176	1,971	5000	0,866	4,533
200	1,663	0,348	1700	1,160	2,065	5500	0,840	4,835
300	1,583	0,497	1800	1,145	2,158	6000	0,815	5,120
400	1,520	0,637	1900	1,131	2,250	6500	0,793	5,395
500	1,468	0,769	2000	1,116	2,338	7000	0,772	5,658
600	1,425	0,895	2200	1,091	2,513	7500	0,753	5,912
700	1,388	1,017	2400	1,068	2,684	8000	0,735	6,153
800	1,354	1,135	2600	1,046	2,847	8500	0,717	6,382
900	1,325	1,249	2800	1,026	3,007	9000	0,701	6,607
1000	1,299	1,360	3000	1,007	3,162	9500	0,686	6,824
1100	1,274	1,467	3200	0,989	3,314	10000	0,672	7,033

The total power "P" and the total torque "M" transmitted by the belt, are calculated with the following formulas:

$$P \text{ [Kw]} = P_{\text{spez}} \cdot Z_e \cdot Z_k \cdot b / 1000$$

$$M \text{ [Nm]} = M_{\text{spez}} \cdot Z_e \cdot Z_k \cdot b / 100$$

$$Z_e = \frac{Z_k}{180} \cdot \arccos \left[\frac{t \cdot (z_g - z_k)}{2 \cdot \pi \cdot A} \right]$$

P = power in Kw

M = torque in Nm

P_{spez} = specific power

M_{spez} = specific torque

Z_e = number of teeth in mesh of the small pulley

Z_emax = 12

Z_k = number of teeth of the small pulley

b = belt width in cm

A = centre distance [mm]

t = pitch

Flexibility

Minimum number of teeth and minimum diameter

Drive without reverse bending

- Timing pulley z_{min} = 10
- Idler running on belt teeth d_{min} = 30 mm

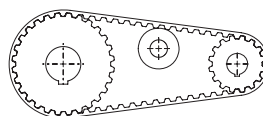

Drive with reverse bending and double sided belt

- Timing pulley z_{min} = 15
- Idler running on belt back d_{min} = 30 mm

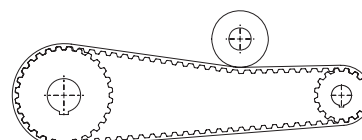

T10 ELA-flex SD™

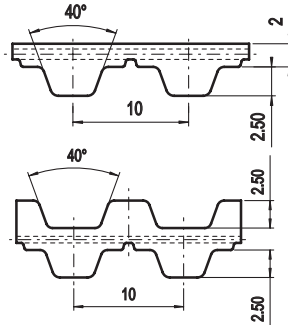
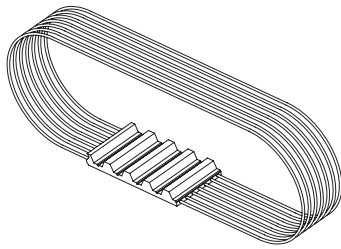

Belt characteristics

- Truly endless polyurethane timing belt with steel tension cords according to DIN 7721 T1
 - Metric pitch 10 mm
 - Ideal for drives where high belt flexibility is requested
 - Allows to use small diameter pulleys
 - Transmissible power up to 30 kW
 - Rpm up to 10.000 [1/min]
- Maximum width: 150 mm
 - Width tolerance: $\pm 0,5$ [mm]
 - Thickness tolerance: $\pm 0,2$ [mm]

Technical data

Belt width [mm]	10	16	25	32	50	75	100	150
Allowable tensile load [N]	1000	1600	2400	3100	4800	7200	9600	14300
Weight [kg/m]	0,05	0,07	0,12	0,15	0,23	0,35	0,46	0,69

Other widths are available on request

Tooth shear strength

rpm [min ⁻¹]	M _{spez} [Ncm/cm]	P _{spez} [W/cm]	rpm [min ⁻¹]	M _{spez} [Ncm/cm]	P _{spez} [W/cm]	rpm [min ⁻¹]	M _{spez} [Ncm/cm]	P _{spez} [W/cm]
0	8,244	0,000	1200	4,808	6,042	3400	3,460	12,318
20	8,009	0,168	1300	4,708	6,409	3600	3,385	12,761
40	7,805	0,327	1400	4,614	6,764	3800	3,312	13,179
60	7,627	0,479	1440	4,577	6,902	4000	3,245	13,592
80	7,472	0,626	1500	4,526	7,109	4500	3,088	14,549
100	7,339	0,768	1600	4,444	7,445	5000	2,946	15,424
200	6,804	1,425	1700	4,366	7,771	5500	2,817	16,224
300	6,411	2,014	1800	4,292	8,090	6000	2,701	16,969
400	6,105	2,557	1900	4,222	8,401	6500	2,593	17,646
500	5,857	3,066	2000	4,157	8,706	7000	2,492	18,269
600	5,648	3,549	2200	4,033	9,291	7500	2,398	18,836
700	5,467	4,007	2400	3,920	9,851	8000	2,311	19,359
800	5,306	4,445	2600	3,815	10,386	8500	2,228	19,832
900	5,163	4,866	2800	3,718	10,901	9000	2,150	20,264
1000	5,034	5,271	3000	3,626	11,389	9500	2,077	20,661
1100	4,916	5,663	3200	3,541	11,866	10000	2,007	21,015

The total power "P" and the total torque "M" transmitted by the belt, are calculated with the following formulas:

$$P \text{ [Kw]} = P_{\text{spez}} \cdot Z_e \cdot Z_k \cdot b / 1000$$

$$M \text{ [Nm]} = M_{\text{spez}} \cdot Z_e \cdot Z_k \cdot b / 100$$

$$Z_e = \frac{Z_k}{180} \cdot \arccos \left[\frac{t \cdot (z_g - z_k)}{2 \cdot \pi \cdot A} \right]$$

P = power in Kw

M = torque in Nm

P_{spez} = specific power

M_{spez} = specific torque

Z_e = number of teeth in mesh of the small pulley

Z_{emax} = 12

Z_k = number of teeth of the small pulley

b = belt width in cm

A = centre distance [mm]

t = pitch

Flexibility

Minimum number of teeth and minimum diameter

Drive without reverse bending

- Timing pulley $z_{\min} = 12$
- Idler running on belt teeth $d_{\min} = 60$ mm

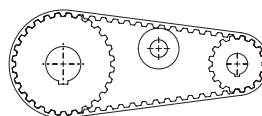

Drive with reverse bending and double sided belt

- Timing pulley $z_{\min} = 20$
- Idler running on belt back $d_{\min} = 60$ mm

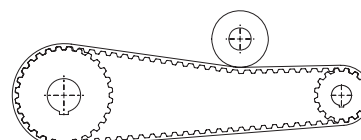

T20 ELA-flex SD™

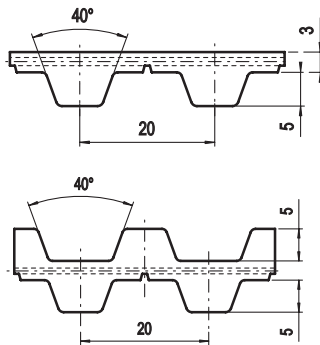
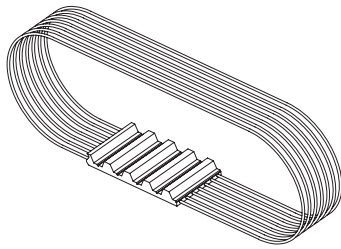

Belt characteristics

- Truly endless polyurethane timing belt with steel tension cords according to DIN 7721 T1
- Metric pitch 20 mm
- Ideal for drives where high belt flexibility is requested
- Transmissible power up to 100 kW
- Rpm up to 6.000 [1/min]
- Maximum width: 150 mm
- Width tolerance: ±1,0 [mm]
- Thickness tolerance: ±0,2 [mm]

Technical data

Belt width [mm]	25	32	50	75	100	150
Allowable tensile load [N]	4000	5100	7900	11900	15800	23700
Weight [kg/m]	0,18	0,23	0,37	0,55	0,73	1,1

Other widths are available on request

Tooth shear strength

rpm [min ⁻¹]	M _{spez} [Ncm/cm]	P _{spez} [W/cm]	rpm [min ⁻¹]	M _{spez} [Ncm/cm]	P _{spez} [W/cm]	rpm [min ⁻¹]	M _{spez} [Ncm/cm]	P _{spez} [W/cm]
0	33,263	0,000	1200	17,542	22,042	3400	11,510	40,978
20	32,181	0,674	1300	17,093	23,268	3600	11,173	42,117
40	31,242	1,309	1400	16,673	24,442	3800	10,851	43,178
60	30,424	1,911	1440	16,511	24,896	4000	10,546	44,170
80	29,714	2,489	1500	16,278	25,568	4500	9,842	46,377
100	29,097	3,047	1600	15,909	26,654	5000	9,209	48,213
200	26,579	5,566	1700	15,562	27,702	5500	8,639	49,753
300	24,777	7,783	1800	15,234	28,714	6000	8,114	50,976
400	23,393	9,798	1900	14,922	29,689	6500	7,630	51,931
500	22,269	11,659	2000	14,623	30,624	7000		
600	21,320	13,395	2200	14,069	32,411	7500		
700	20,502	15,028	2400	13,563	34,086	8000		
800	19,783	16,572	2600	13,092	35,643	8500		
900	19,140	18,038	2800	12,659	37,116	9000		
1000	18,561	19,435	3000	12,252	38,487	9500		
1100	18,029	20,766	3200	11,870	39,773	10000		

The total power "P" and the total torque "M" transmitted by the belt, are calculated with the following formulas:

$$P \text{ [Kw]} = P_{\text{spez}} \cdot Z_e \cdot Z_k \cdot b / 1000$$

$$M \text{ [Nm]} = M_{\text{spez}} \cdot Z_e \cdot Z_k \cdot b / 100$$

$$Z_e = \frac{Z_k}{180} \cdot \arccos \left[\frac{t \cdot (z_g - z_k)}{2 \cdot \pi \cdot A} \right]$$

P = power in Kw

M = torque in Nm

P_{spez} = specific power

M_{spez} = specific torque

Z_e = number of teeth in mesh of the small pulley

Z_{emax} = 12

Z_k = number of teeth of the small pulley

b = belt width in cm

A = centre distance [mm]

t = pitch

Flexibility

Minimum number of teeth and minimum diameter

Drive without reverse bending

- Timing pulley $z_{\min} = 15$
- Idler running on belt teeth $d_{\min} = 120 \text{ mm}$

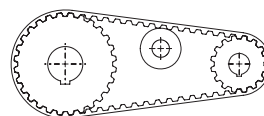

Drive with reverse bending and double sided belt

- Timing pulley $z_{\min} = 25$
- Idler running on belt back $d_{\min} = 120 \text{ mm}$

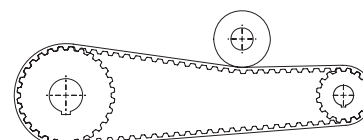

AT5 ELA-flex SD™

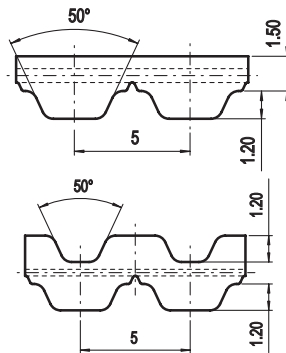
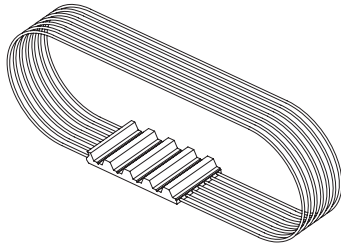

Belt characteristics

- Truly endless polyurethane timing belt with steel tension cords. Metric pitch 5 mm
- Tooth profile and dimension are optimised to guarantee uniform load distribution and minimum deformation under load
- High resistance and low stretch steel cords to guarantee high stability and low elongation
- Reduced polygonal effect with reduced drive vibration and noise
- Transmissible power up to 15 kW
- Rpm up to 10.000 [1/min]
- Maximum width: 150 mm
- Width tolerance: ±0,5 [mm]
- Thickness tolerance: ±0,2 [mm]

Technical data

Belt width [mm]	10	16	25	32	50	75	100	150
Allowable tensile load [N]	1000	1600	2400	3100	4800	7200	9600	14300
Weight [kg/m]	0,03	0,05	0,08	0,11	0,17	0,25	0,33	0,50

Other widths are available on request

Tooth shear strength

rpm [min ⁻¹]	M _{spez} [Ncm/cm]	P _{spez} [W/cm]	rpm [min ⁻¹]	M _{spez} [Ncm/cm]	P _{spez} [W/cm]	rpm [min ⁻¹]	M _{spez} [Ncm/cm]	P _{spez} [W/cm]
0	2,897	0,000	1200	2,027	2,547	3400	1,514	5,391
20	2,855	0,060	1300	1,990	2,709	3600	1,485	5,598
40	2,817	0,118	1400	1,955	2,866	3800	1,456	5,795
60	2,783	0,175	1440	1,942	2,929	4000	1,429	5,986
80	2,753	0,231	1500	1,923	3,020	4500	1,367	6,442
100	2,725	0,285	1600	1,892	3,170	5000	1,311	6,862
200	2,620	0,549	1700	1,863	3,316	5500	1,260	7,255
300	2,540	0,798	1800	1,836	3,460	6000	1,213	7,619
400	2,458	1,030	1900	1,809	3,599	6500	1,169	7,957
500	2,383	1,248	2000	1,784	3,736	7000	1,128	8,271
600	2,317	1,456	2200	1,736	4,000	7500	1,091	8,568
700	2,258	1,655	2400	1,693	4,256	8000	1,055	8,839
800	2,204	1,846	2600	1,653	4,500	8500	1,023	9,101
900	2,153	2,029	2800	1,615	4,734	9000	0,991	9,337
1000	2,108	2,207	3000	1,580	4,962	9500	0,961	9,555
1100	2,066	2,379	3200	1,546	5,181	10000	0,933	9,766

The total power "P" and the total torque "M" transmitted by the belt, are calculated with the following formulas:

$$P \text{ [Kw]} = P_{\text{spez}} \cdot Z_e \cdot Z_k \cdot b / 1000$$

$$M \text{ [Nm]} = M_{\text{spez}} \cdot Z_e \cdot Z_k \cdot b / 100$$

$$Z_e = \frac{Z_k}{180} \cdot \arccos \left[\frac{t \cdot (z_g - z_k)}{2 \cdot \pi \cdot A} \right]$$

P = power in Kw

M = torque in Nm

P_{spez} = specific power

M_{spez} = specific torque

Z_e = number of teeth in mesh of the small pulley

Z_emax = 12

Z_k = number of teeth of the small pulley

b = belt width in cm

A = centre distance [mm]

t = pitch

Flexibility

Minimum number of teeth and minimum diameter

Drive without reverse bending

- Timing pulley z_{min} = 15
- Idler running on belt teeth d_{min} = 30 mm

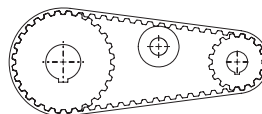

Drive with reverse bending and double sided belt

- Timing pulley z_{min} = 25
- Idler running on belt back d_{min} = 60 mm

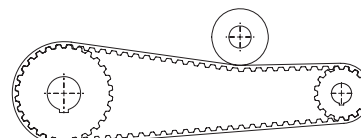

AT10 ELA-flex SD™

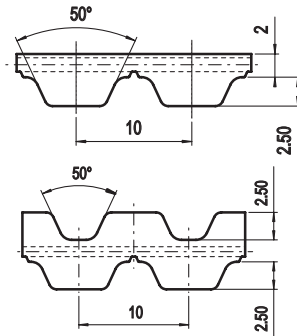
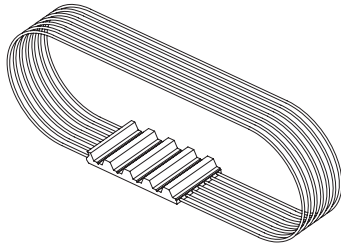

Belt characteristics

- Truly endless polyurethane timing belt with steel tension cords. Metric pitch 10 mm
- Tooth profile and dimension are optimised to guarantee uniform load distribution and minimum deformation under load
- High resistance and low stretch steel cords to guarantee high stability and low elongation
- Reduced polygonal effect with reduced drive vibration and noise
- Transmissible power up to 70 kW
- Rpm up to 10.000 [1/min]
- Maximum width: 150 mm
- Width tolerance: ±0,5 [mm]
- Thickness tolerance: ±0,2 [mm]

Technical data

Belt width [mm]	16	25	32	50	75	100	150
Allowable tensile load [N]	2600	4000	5100	7900	11900	15800	23700
Weight [kg/m]	0,09	0,14	0,18	0,29	0,43	0,57	0,86

Other widths are available on request

Tooth shear strength

rpm [min ⁻¹]	M _{spez} [Ncm/cm]	P _{spez} [W/cm]	rpm [min ⁻¹]	M _{spez} [Ncm/cm]	P _{spez} [W/cm]	rpm [min ⁻¹]	M _{spez} [Ncm/cm]	P _{spez} [W/cm]
0	12,048	0,000	1200	7,708	9,685	3400	5,317	18,931
20	11,871	0,249	1300	7,534	10,256	3600	5,180	19,529
40	11,706	0,490	1400	7,372	10,807	3800	5,048	20,088
60	11,550	0,726	1440	7,310	11,022	4000	4,924	20,625
80	11,403	0,955	1500	7,219	11,339	4500	4,636	21,846
100	11,265	1,180	1600	7,076	11,855	5000	4,377	22,915
200	10,684	2,238	1700	6,939	12,352	5500	4,140	23,841
300	10,215	3,209	1800	6,810	12,836	6000	3,923	24,648
400	9,793	4,102	1900	6,688	13,305	6500	3,724	25,348
500	9,424	4,934	2000	6,570	13,759	7000	3,538	25,933
600	9,097	5,716	2200	6,349	14,625	7500	3,365	26,423
700	8,808	6,456	2400	6,147	15,447	8000	3,202	26,825
800	8,547	7,159	2600	5,959	16,223	8500	3,048	27,127
900	8,309	7,831	2800	5,782	16,953	9000	2,903	27,358
1000	8,093	8,474	3000	5,618	17,649	9500	2,766	27,516
1100	7,893	9,091	3200	5,464	18,308	10000	2,636	27,598

The total power "P" and the total torque "M" transmitted by the belt, are calculated with the following formulas:

$$P \text{ [Kw]} = P_{\text{spez}} \cdot Z_e \cdot Z_k \cdot b / 1000$$

$$M \text{ [Nm]} = M_{\text{spez}} \cdot Z_e \cdot Z_k \cdot b / 100$$

$$Z_e = \frac{Z_k}{180} \cdot \arccos \left[\frac{t \cdot (z_g - z_k)}{2 \cdot \pi \cdot A} \right]$$

- P = power in Kw
- M = torque in Nm
- P_{spez} = specific power
- M_{spez} = specific torque
- Z_e = number of teeth in mesh of the small pulley
- Z_emax = 12
- Z_k = number of teeth of the small pulley
- b = belt width in cm
- A = centre distance [mm]
- t = pitch

Flexibility

Minimum number of teeth and minimum diameter

Drive without reverse bending

- Timing pulley z_{min} = 15
- Idler running on belt teeth d_{min} = 50 mm

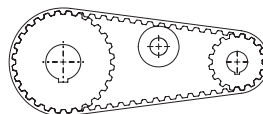

Drive with reverse bending and double sided belt

- Timing pulley z_{min} = 25
- Idler running on belt back d_{min} = 120 mm

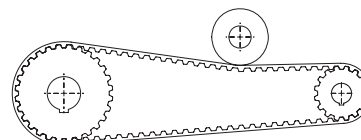

AT20 ELA-flex SD™

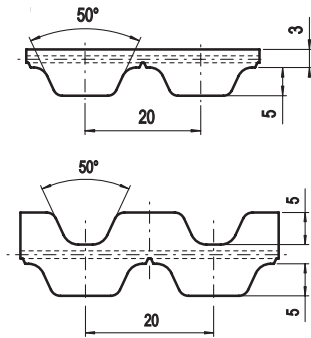
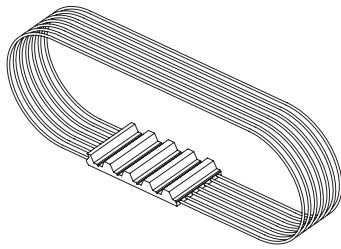

Belt characteristics

- Truly endless polyurethane timing belt with steel tension cords. Metric pitch 10 mm
- Tooth profile and dimension are optimised to guarantee uniform load distribution and minimum deformation under load
- High resistance and low stretch steel cords to guarantee high stability and low elongation
- Reduced polygonal effect with reduced drive vibration and noise
- Transmissible power up to 200 kW
- Rpm up to 6.000 [1/min]
- Maximum width: 150 mm
- Width tolerance: ±1,0 [mm]
- Thickness tolerance: ±0,2 [mm]

Technical data

Belt width [mm]	25	32	50	75	100	150
Allowable tensile load [N]	6700	8600	13400	20100	26800	40200
Weight [kg/m]	0,24	0,31	0,48	0,73	0,97	1,45

Other widths are available on request

Tooth shear strength

rpm [min ⁻¹]	M _{spez} [Ncm/cm]	P _{spez} [W/cm]	rpm [min ⁻¹]	M _{spez} [Ncm/cm]	P _{spez} [W/cm]	rpm [min ⁻¹]	M _{spez} [Ncm/cm]	P _{spez} [W/cm]
0	48,192	0,000	1200	27,063	34,006	3400	15,842	56,402
20	47,288	0,990	1300	26,251	35,734	3600	15,196	57,284
40	46,438	1,945	1400	25,487	37,363	3800	14,579	58,009
60	45,639	2,867	1440	25,197	37,994	4000	13,993	58,609
80	44,885	3,760	1500	24,771	38,907	4500	12,643	59,576
100	44,175	4,626	1600	24,096	40,370	5000	11,427	59,829
200	41,199	8,628	1700	23,456	41,755	5500	10,320	59,432
300	38,923	12,227	1800	22,845	43,059	6000	9,304	58,456
400	36,911	15,460	1900	22,269	44,305	6500		
500	35,157	18,407	2000	21,715	45,477	7000		
600	33,617	21,120	2200	20,681	47,641	7500		
700	32,248	23,637	2400	19,729	49,580	8000		
800	31,016	25,982	2600	18,844	51,303	8500		
900	29,899	28,177	2800	18,023	52,841	9000		
1000	28,880	30,241	3000	17,252	54,196	9500		
1100	27,938	32,180	3200	16,527	55,377	10000		

The total power "P" and the total torque "M" transmitted by the belt, are calculated with the following formulas:

$$P \text{ [Kw]} = P_{\text{spez}} \cdot Z_e \cdot Z_k \cdot b / 1000$$

$$M \text{ [Nm]} = M_{\text{spez}} \cdot Z_e \cdot Z_k \cdot b / 100$$

$$Z_e = \frac{Z_k}{180} \cdot \arccos \left[\frac{t \cdot (z_g - z_k)}{2 \cdot \pi \cdot A} \right]$$

P = power in Kw

M = torque in Nm

P_{spez} = specific power

M_{spez} = specific torque

Z_e = number of teeth in mesh of the small pulley

Z_emax = 12

Z_k = number of teeth of the small pulley

b = belt width in cm

A = centre distance [mm]

t = pitch

Flexibility

Minimum number of teeth and minimum diameter

Drive without reverse bending

- Timing pulley $z_{\min} = 18$
- Idler running on belt teeth $d_{\min} = 120 \text{ mm}$

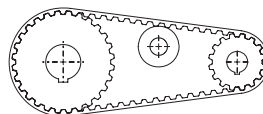

Drive with reverse bending and double sided belt

- Timing pulley $z_{\min} = 25$
- Idler running on belt back $d_{\min} = 180 \text{ mm}$

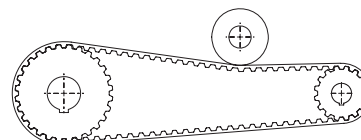

XL ELA-flex SD™

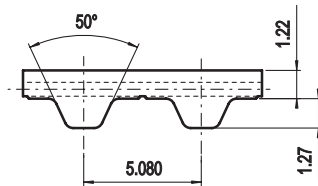
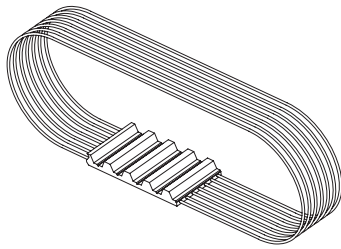

Belt characteristics

- Truly endless polyurethane timing belt with steel tension cords and trapezoidal tooth profile according to DIN/ISO 5296.
 - Imperial pitch 1/5" = 5,08 mm
 - Allow to use small diameter pulley
 - Mainly used in applications where inch pitch is an advantage
 - Transmissible power up to 5 kW
 - Rpm up to 10.000 [1/min]
- Maximum width: 150 mm
 - Width tolerance: ±0,5 [mm]
 - Thickness tolerance: ±0,2 [mm]

Technical data

Belt width [inch]	0,25	0,31	0,37	0,50	0,75	1,00	1,50	2,00	4,00
Allowable tensile load [N]	220	280	330	440	650	870	1300	1720	3440
Weight [kg/m]	0,016	0,020	0,024	0,033	0,049	0,065	0,098	0,130	0,260

Other widths are available on request

Tooth shear strength

rpm [min ⁻¹]	M _{spez} [Ncm/cm]	P _{spez} [W/cm]	rpm [min ⁻¹]	M _{spez} [Ncm/cm]	P _{spez} [W/cm]	rpm [min ⁻¹]	M _{spez} [Ncm/cm]	P _{spez} [W/cm]
0	2,029	0,000	1200	1,294	1,626	3400	1,006	3,581
20	1,978	0,041	1300	1,273	1,732	3600	0,990	3,730
40	1,932	0,081	1400	1,252	1,836	3800	0,974	3,877
60	1,894	0,119	1440	1,245	1,877	4000	0,960	4,020
80	1,860	0,156	1500	1,234	1,938	4500	0,926	4,362
100	1,830	0,192	1600	1,216	2,037	5000	0,896	4,690
200	1,717	0,360	1700	1,200	2,136	5500	0,868	5,001
300	1,635	0,514	1800	1,184	2,231	6000	0,843	5,298
400	1,570	0,658	1900	1,169	2,326	6500	0,820	5,580
500	1,518	0,795	2000	1,155	2,418	7000	0,798	5,849
600	1,473	0,926	2200	1,129	2,600	7500	0,779	6,115
700	1,434	1,051	2400	1,104	2,776	8000	0,759	6,360
800	1,400	1,173	2600	1,082	2,945	8500	0,741	6,599
900	1,370	1,291	2800	1,061	3,110	9000	0,725	6,835
1000	1,342	1,405	3000	1,041	3,271	9500	0,709	7,053
1100	1,317	1,517	3200	1,023	3,427	10000	0,695	7,272

The total power "P" and the total torque "M" transmitted by the belt, are calculated with the following formulas:

$$P \text{ [Kw]} = P_{\text{spez}} \cdot Z_e \cdot Z_k \cdot b / 1000$$

$$M \text{ [Nm]} = M_{\text{spez}} \cdot Z_e \cdot Z_k \cdot b / 100$$

$$Z_e = \frac{Z_k \cdot \arccos \left[\frac{t \cdot (Z_g - Z_k)}{2 \cdot \pi \cdot A} \right]}{180}$$

P = power in Kw

M = torque in Nm

P_{spez} = specific power

M_{spez} = specific torque

Z_e = number of teeth in mesh of the small pulley

Z_{emax} = 12

Z_k = number of teeth of the small pulley

b = belt width in cm

A = centre distance [mm]

t = pitch

Flexibility

Minimum number of teeth and minimum diameter

Drive without reverse bending

- Timing pulley z_{min} = 10
- Idler running on belt teeth d_{min} = 30 mm

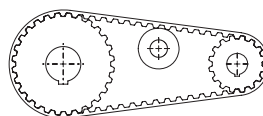

Drive with reverse bending and double sided belt

- Timing pulley z_{min} = 15
- Idler running on belt back d_{min} = 30 mm

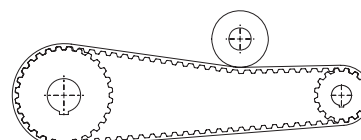

L ELA-flex SD™

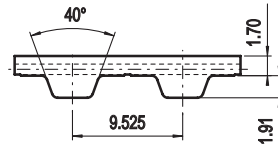
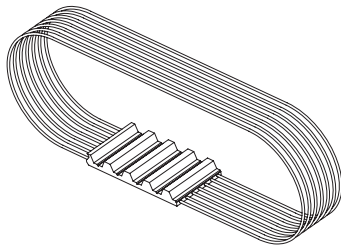

Belt characteristics

- Truly endless polyurethane timing belt with steel tension cords and trapezoidal tooth profile according to DIN/ISO 5296.
 - Imperial pitch 3/8" = 9,525 mm
 - Mainly used in applications where inch pitch is an advantage
 - Transmissible power up to 20 kW
 - Rpm up to 10.000 [1/min]
- Maximum width: 150 mm
 - Width tolerance: ±0,5 [mm]
 - Thickness tolerance: ±0,2 [mm]

Technical data

Belt width [inch]	0,50	0,75	1,00	1,50	2,00	3,00	4,00	6,00
Allowable tensile load [N]	1220	1820	2430	3640	4850	7260	9680	14520
Weight [kg/m]	0,05	0,08	0,10	0,15	0,20	0,30	0,40	0,60

Other widths are available on request

Tooth shear strength

rpm [min ⁻¹]	M _{spez} [Ncm/cm]	P _{spez} [W/cm]	rpm [min ⁻¹]	M _{spez} [Ncm/cm]	P _{spez} [W/cm]	rpm [min ⁻¹]	M _{spez} [Ncm/cm]	P _{spez} [W/cm]
0	5,852	0,000	1200	3,393	4,263	3400	2,441	8,689
20	5,673	0,119	1300	3,321	4,521	3600	2,388	9,000
40	5,518	0,231	1400	3,256	4,774	3800	2,336	9,295
60	5,383	0,338	1440	3,230	4,871	4000	2,288	9,581
80	5,266	0,441	1500	3,194	5,017	4500	2,177	10,258
100	5,165	0,541	1600	3,137	5,255	5000	2,077	10,874
200	4,789	1,003	1700	3,082	5,486	5500	1,986	11,437
300	4,516	1,419	1800	3,029	5,709	6000	1,903	11,953
400	4,304	1,803	1900	2,980	5,930	6500	1,827	12,433
500	4,131	2,163	2000	2,933	6,143	7000	1,755	12,867
600	3,984	2,503	2200	2,845	6,555	7500	1,689	13,263
700	3,857	2,827	2400	2,765	6,949	8000	1,627	13,626
800	3,744	3,137	2600	2,692	7,330	8500	1,569	13,965
900	3,644	3,434	2800	2,623	7,689	9000	1,513	14,258
1000	3,553	3,721	3000	2,559	8,039	9500	1,461	14,537
1100	3,470	3,997	3200	2,498	8,371	10000	1,411	14,779

The total power "P" and the total torque "M" transmitted by the belt, are calculated with the following formulas:

$$P \text{ [Kw]} = P_{\text{spez}} \cdot Z_e \cdot Z_k \cdot b / 1000$$

$$M \text{ [Nm]} = M_{\text{spez}} \cdot Z_e \cdot Z_k \cdot b / 100$$

$$Z_e = \frac{Z_k \cdot \arccos\left[\frac{t \cdot (z_g - z_k)}{2 \cdot \pi \cdot A}\right]}{180}$$

P = power in Kw

M = torque in Nm

P_{spez} = specific power

M_{spez} = specific torque

Z_e = number of teeth in mesh of the small pulley

Z_emax = 12

Z_k = number of teeth of the small pulley

b = belt width in cm

A = centre distance [mm]

t = pitch

Flexibility

Minimum number of teeth and minimum diameter

Drive without reverse bending

- Timing pulley z_{min} = 15
- Idler running on belt teeth d_{min} = 60 mm

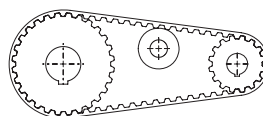

Drive with reverse bending and double sided belt

- Timing pulley z_{min} = 20
- Idler running on belt back d_{min} = 60 mm

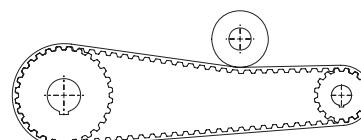

H ELA-flex SD™

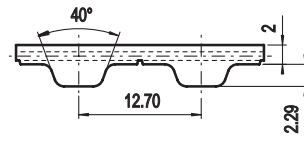
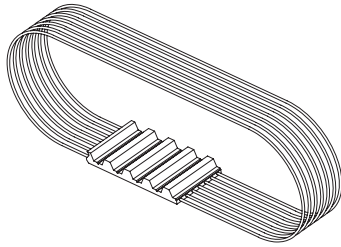

Belt characteristics

- Truly endless polyurethane timing belt with steel tension cords and trapezoidal tooth profile according to DIN/ISO 5296.
 - Imperial pitch 1/2" = 12,7 mm
 - Allow to use small diameter pulley
 - Mainly used in applications where inch pitch is an advantage
 - Transmissible power up to 30 kW
 - Rpm up to 10.000 [1/min]
- Maximum width: 150 mm
 - Width tolerance: ±0,5 [mm]
 - Thickness tolerance: ±0,2 [mm]

Technical data

Belt width [inch]	0,50	0,75	1,00	1,50	2,00	3,00	4,00	6,00
Allowable tensile load [N]	1220	1820	2430	3640	4850	7260	9680	14520
Weight [kg/m]	0,056	0,084	0,113	0,169	0,225	0,338	0,450	0,675

Other widths are available on request

Tooth shear strength

rpm [min ⁻¹]	M _{spez} [Ncm/cm]	P _{spez} [W/cm]	rpm [min ⁻¹]	M _{spez} [Ncm/cm]	P _{spez} [W/cm]	rpm [min ⁻¹]	M _{spez} [Ncm/cm]	P _{spez} [W/cm]
0	9,156	0,000	1200	5,318	6,682	3400	3,826	13,622
20	8,883	0,186	1300	5,207	7,088	3600	3,741	14,104
40	8,647	0,362	1400	5,104	7,482	3800	3,663	14,573
60	8,443	0,530	1440	5,063	7,635	4000	3,588	15,027
80	8,263	0,692	1500	5,007	7,864	4500	3,412	16,077
100	8,107	0,849	1600	4,916	8,236	5000	3,256	17,049
200	7,523	1,576	1700	4,829	8,596	5500	3,115	17,939
300	7,089	2,227	1800	4,748	8,949	6000	2,983	18,744
400	6,753	2,829	1900	4,671	9,293	6500	2,864	19,494
500	6,478	3,392	2000	4,596	9,626	7000	2,753	20,179
600	6,246	3,924	2200	4,461	10,277	7500	2,650	20,811
700	6,046	4,431	2400	4,334	10,891	8000	2,553	21,385
800	5,870	4,917	2600	4,218	11,485	8500	2,462	21,912
900	5,712	5,383	2800	4,111	12,054	9000	2,375	22,382
1000	5,569	5,831	3000	4,010	12,597	9500	2,294	22,821
1100	5,437	6,263	3200	3,915	13,119	10000	2,215	23,197

The total power "P" and the total torque "M" transmitted by the belt, are calculated with the following formulas:

$$P \text{ [Kw]} = P_{\text{spez}} \cdot Z_e \cdot Z_k \cdot b / 1000$$

$$M \text{ [Nm]} = M_{\text{spez}} \cdot Z_e \cdot Z_k \cdot b / 100$$

$$Z_e = \frac{Z_k}{180} \cdot \arccos \left[\frac{t \cdot (z_g - z_k)}{2 \cdot \pi \cdot A} \right]$$

P = power in Kw

M = torque in Nm

P_{spez} = specific power

M_{spez} = specific torque

Z_e = number of teeth in mesh of the small pulley

Z_emax = 12

Z_k = number of teeth of the small pulley

b = belt width in cm

A = centre distance [mm]

t = pitch

Flexibility

Minimum number of teeth and minimum diameter

Drive without reverse bending

- Timing pulley z_{min} = 14
- Idler running on belt teeth d_{min} = 60 mm

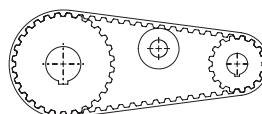

Drive with reverse bending and double sided belt

- Timing pulley z_{min} = 20
- Idler running on belt back d_{min} = 80 mm

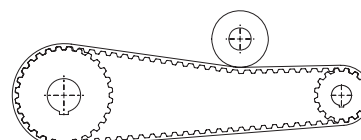

XH ELA-flex SD™

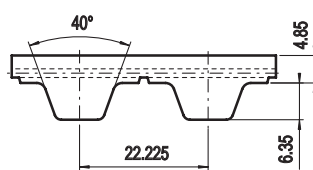
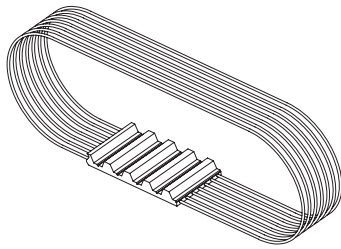

Belt characteristics

- Truly endless polyurethane timing belt with steel tension cords and trapezoidal tooth profile according to DIN/ISO 5296.
 - Imperial pitch 7/8" = 22,225 mm
 - Mainly used in applications where inch pitch is an advantage
 - Transmissible power up to 100 kW
 - Rpm up to 4.500 [1/min]
- Maximum width: 150 mm
 - Width tolerance: ±1,0 [mm]
 - Thickness tolerance: ±0,2 [mm]

Technical data

Belt width [inch]	1,00	2,00	3,00	4,00	6,00
Allowable tensile load [N]	4010	8010	12010	16010	24010
Weight [kg/m]	0,27	0,53	0,80	1,06	1,59

Other widths are available on request

Tooth shear strength

rpm [min ⁻¹]	M _{spez} [Ncm/cm]	P _{spez} [W/cm]	rpm [min ⁻¹]	M _{spez} [Ncm/cm]	P _{spez} [W/cm]	rpm [min ⁻¹]	M _{spez} [Ncm/cm]	P _{spez} [W/cm]
0	33,957	0,000	1200	17,802	22,369	3400	12,904	43,237
20	32,889	0,689	1300	17,405	23,692	3600	12,599	44,855
40	31,932	1,337	1400	17,037	24,975	3800	12,312	46,411
60	31,074	1,952	1440	16,897	25,477	4000	12,040	47,907
80	30,306	2,539	1500	16,693	26,220	4500	11,782	49,347
100	29,618	3,101	1600	16,372	27,430	5000		
200	26,460	5,541	1700	16,070	28,606	5500		
300	24,554	7,713	1800	15,785	29,752	6000		
400	23,178	9,708	1900	15,515	30,867	6500		
500	22,100	11,571	2000	15,259	31,955	7000		
600	21,213	13,327	2200	14,782	34,053	7500		
700	20,459	14,996	2400	14,347	36,054	8000		
800	19,804	16,590	2600	13,946	37,967	8500		
900	19,224	18,117	2800	13,574	39,798	9000		
1000	18,704	19,586	3000	13,433	40,509	9500		
1100	18,233	21,001	3200	13,228	41,553	10000		

The total power "P" and the total torque "M" transmitted by the belt, are calculated with the following formulas:

$$P \text{ [Kw]} = P_{\text{spez}} \cdot Z_e \cdot Z_k \cdot b / 1000$$

$$M \text{ [Nm]} = M_{\text{spez}} \cdot Z_e \cdot Z_k \cdot b / 100$$

$$Z_e = \frac{Z_k \cdot \arccos \left[\frac{t \cdot (z_g - z_k)}{2 \cdot \pi \cdot A} \right]}{180}$$

P = power in Kw

M = torque in Nm

P_{spez} = specific power

M_{spez} = specific torque

Z_e = number of teeth in mesh of the small pulley

Z_{emax} = 12

Z_k = number of teeth of the small pulley

b = belt width in cm

A = centre distance [mm]

t = pitch

Flexibility

Minimum number of teeth and minimum diameter

Drive without reverse bending

- Timing pulley $z_{\min} = 18$
- Idler running on belt teeth $d_{\min} = 150 \text{ mm}$

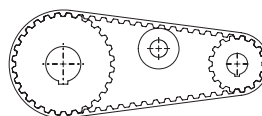

Drive with reverse bending and double sided belt

- Timing pulley $z_{\min} = 20$
- Idler running on belt back $d_{\min} = 180 \text{ mm}$

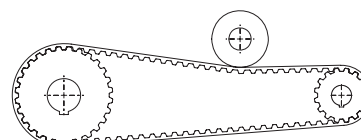

HTD5M ELA-flex SD™

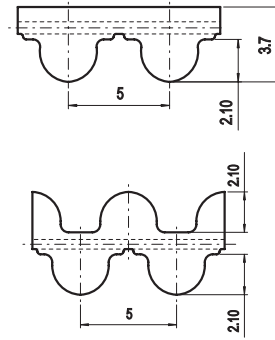
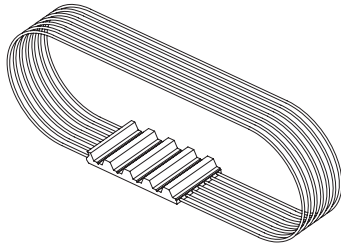

Belt characteristics

- Truly endless polyurethane timing belt with round tooth profile and steel tension cords. Produced according to ISO 13050
 - Metric pitch 5 mm
 - The round tooth profile allows a uniform load distribution that guarantees high performance, high transmissible torque and precise tooth engagement
 - Transmissible power up to 6 kW
 - Rpm up to 10.000 [1/min]
- Maximum width: 150 mm
 - Width tolerance: ±0,5 [mm]
 - Thickness tolerance: ±0,2 [mm]

Technical data

Belt width [mm]	10	15	25	50	100	150
Allowable tensile load [N]	1000	1500	2400	4800	9600	14300
Weight [kg/m]	0,05	0,07	0,11	0,23	0,46	0,68

Other widths are available on request

Tooth shear strength

rpm [min ⁻¹]	M _{spez} [Ncm/cm]	P _{spez} [W/cm]	rpm [min ⁻¹]	M _{spez} [Ncm/cm]	P _{spez} [W/cm]	rpm [min ⁻¹]	M _{spez} [Ncm/cm]	P _{spez} [W/cm]
0	2,928	0,000	1200	1,992	2,503	3400	1,461	5,203
20	2,885	0,060	1300	1,955	2,661	3600	1,430	5,390
40	2,845	0,119	1400	1,920	2,814	3800	1,400	5,570
60	2,809	0,176	1440	1,906	2,875	4000	1,371	5,743
80	2,776	0,233	1500	1,887	2,964	4500	1,305	6,148
100	2,747	0,288	1600	1,855	3,109	5000	1,245	6,517
200	2,637	0,552	1700	1,826	3,250	5500	1,190	6,854
300	2,457	0,772	1800	1,797	3,387	6000	1,140	7,161
400	2,395	1,003	1900	1,770	3,521	6500	1,093	7,440
500	2,333	1,221	2000	1,744	3,652	7000	1,050	7,695
600	2,273	1,428	2200	1,695	3,904	7500	1,009	7,926
700	2,217	1,625	2400	1,649	4,145	8000	0,971	8,135
800	2,166	1,814	2600	1,607	4,375	8500	0,935	8,324
900	2,118	1,996	2800	1,567	4,595	9000	0,901	8,493
1000	2,073	2,170	3000	1,530	4,806	9500	0,869	8,644
1100	2,031	2,339	3200	1,495	5,009	10000	0,838	8,778

The total power "P" and the total torque "M" transmitted by the belt, are calculated with the following formulas:

$$P \text{ [Kw]} = P_{\text{spez}} \cdot Z_e \cdot Z_k \cdot b / 1000$$

$$M \text{ [Nm]} = M_{\text{spez}} \cdot Z_e \cdot Z_k \cdot b / 100$$

$$Z_e = \frac{Z_k}{180} \cdot \arccos \left[\frac{t \cdot (z_g - z_k)}{2 \cdot \pi \cdot A} \right]$$

P = power in Kw

M = torque in Nm

P_{spez} = specific power

M_{spez} = specific torque

Z_e = number of teeth in mesh of the small pulley

Z_{emax} = 12

Z_k = number of teeth of the small pulley

b = belt width in cm

A = centre distance [mm]

t = pitch

Flexibility

Minimum number of teeth and minimum diameter

Drive without reverse bending

- Timing pulley $z_{\min} = 16$
- Idler running on belt teeth $d_{\min} = 50 \text{ mm}$

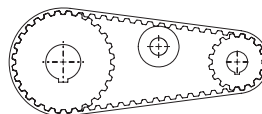

Drive with reverse bending and double sided belt

- Timing pulley $z_{\min} = 20$
- Idler running on belt back $d_{\min} = 50 \text{ mm}$

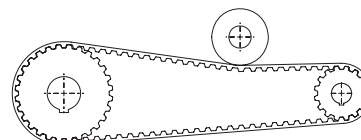

HTD8M ELA-flex SD™

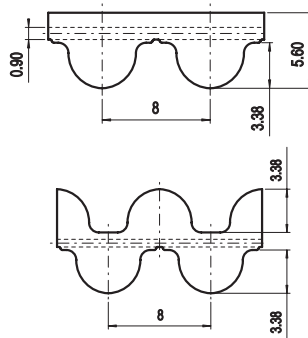
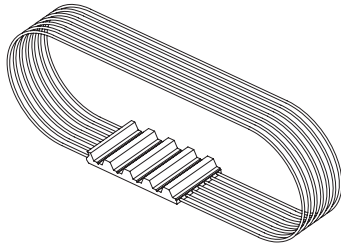

Belt characteristics

- Truly endless polyurethane timing belt with round tooth profile and steel tension cords. Produced according to ISO 13050
 - Metric pitch 8 mm
 - The round tooth profile, allows a uniform load distribution that guarantees high performance, high transmissible torque and precise tooth engagement
 - Transmissible power up to 80 kW
 - Rpm up to 6.000 [1/min]
- Maximum width: 150 mm
 - Width tolerance: ±0,5 [mm]
 - Thickness tolerance: ±0,2 [mm]

Technical data

Belt width [mm]	10	15	20	30	50	85	100	150
Allowable tensile load [N]	1600	2400	3200	4800	7900	13400	15800	23700
Weight [kg/m]	0,07	0,10	0,13	0,20	0,33	0,56	0,66	1,00

Other widths are available on request

Tooth shear strength

rpm [min ⁻¹]	M _{spez} [Ncm/cm]	P _{spez} [W/cm]	rpm [min ⁻¹]	M _{spez} [Ncm/cm]	P _{spez} [W/cm]	rpm [min ⁻¹]	M _{spez} [Ncm/cm]	P _{spez} [W/cm]
0	9,422	0,000	1200	5,848	7,348	3400	3,936	14,013
20	9,246	0,194	1300	5,709	7,772	3600	3,826	14,421
40	9,083	0,380	1400	5,580	8,180	3800	3,721	14,805
60	8,933	0,561	1440	5,530	8,338	4000	3,621	15,166
80	8,794	0,737	1500	5,458	8,572	4500	3,390	15,975
100	8,666	0,907	1600	5,343	8,951	5000	3,183	16,663
200	8,160	1,709	1700	5,233	9,316	5500	2,994	17,241
300	7,853	2,467	1800	5,130	9,669	6000	2,821	17,720
400	7,516	3,148	1900	5,031	10,010	6500		
500	7,220	3,780	2000	4,937	10,340	7000		
600	6,959	4,372	2200	4,761	10,968	7500		
700	6,728	4,931	2400	4,599	11,557	8000		
800	6,519	5,461	2600	4,448	12,110	8500		
900	6,330	5,965	2800	4,308	12,630	9000		
1000	6,156	6,446	3000	4,176	13,119	9500		
1100	5,996	6,907	3200	4,053	13,580	10000		

The total power "P" and the total torque "M" transmitted by the belt, are calculated with the following formulas:

$$P \text{ [Kw]} = P_{\text{spez}} \cdot Z_e \cdot Z_k \cdot b / 1000$$

$$M \text{ [Nm]} = M_{\text{spez}} \cdot Z_e \cdot Z_k \cdot b / 100$$

$$Z_e = \frac{Z_k}{180} \cdot \arccos \left[\frac{t \cdot (z_g - z_k)}{2 \cdot \pi \cdot A} \right]$$

P = power in Kw

M = torque in Nm

P_{spez} = specific power

M_{spez} = specific torque

Z_e = number of teeth in mesh of the small pulley

Z_{emax} = 12

Z_k = number of teeth of the small pulley

b = belt width in cm

A = centre distance [mm]

t = pitch

Flexibility

Minimum number of teeth and minimum diameter

Drive without reverse bending

- Timing pulley $z_{\min} = 18$
- Idler running on belt teeth $d_{\min} = 50 \text{ mm}$

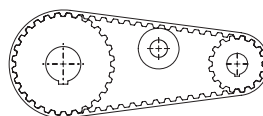

Drive with reverse bending and double sided belt

- Timing pulley $z_{\min} = 18$
- Idler running on belt back $d_{\min} = 120 \text{ mm}$

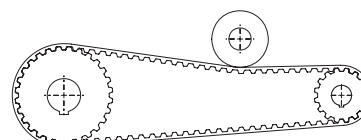

HTD14M ELA-flex SD™

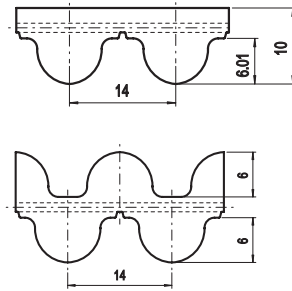
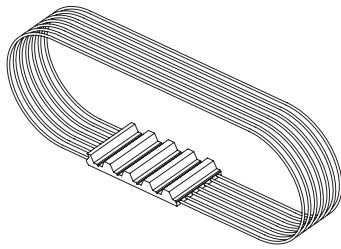

Belt characteristics

- Truly endless polyurethane timing belt with round tooth profile and steel tension cords. Produced according to ISO 13050
 - Metric pitch 14 mm
 - The round tooth profile, allows a uniform load distribution that guarantees high performance, high transmissible torque and precise tooth engagement
 - Transmissible power up to 200 kW
 - Rpm up to 4.000 [1/min]
- Maximum width: 150 mm
 - Width tolerance: ±1,0 [mm]
 - Thickness tolerance: ±0,2 [mm]

Technical data

Belt width [mm]	40	55	85	115	150
Allowable tensile load [N]	10800	14800	22800	30900	41000
Weight [kg/m]	0,42	0,57	0,89	1,24	1,7

Other widths are available on request

Tooth shear strength

rpm [min ⁻¹]	M _{spez} [Ncm/cm]	P _{spez} [W/cm]	rpm [min ⁻¹]	M _{spez} [Ncm/cm]	P _{spez} [W/cm]	rpm [min ⁻¹]	M _{spez} [Ncm/cm]	P _{spez} [W/cm]
0	28,966	0,000	1200	16,335	20,526	3400	9,630	34,286
20	28,452	0,596	1300	15,852	21,578	3600	9,242	34,837
40	27,978	1,172	1400	15,398	22,573	3800	8,872	35,303
60	27,540	1,730	1440	15,225	22,957	4000	8,521	35,688
80	27,136	2,273	1500	14,972	23,516	4500		
100	26,762	2,802	1600	14,569	24,408	5000		
200	24,458	5,122	1700	14,187	25,254	5500		
300	23,239	7,300	1800	13,824	26,056	6000		
400	22,100	9,257	1900	13,478	26,816	6500		
500	21,091	11,042	2000	13,148	27,536	7000		
600	20,195	12,688	2200	12,530	28,865	7500		
700	19,394	14,216	2400	11,960	30,056	8000		
800	18,672	15,641	2600	11,431	31,121	8500		
900	18,014	16,976	2800	10,938	32,069	9000		
1000	17,410	18,230	3000	10,476	32,908	9500		
1100	16,853	19,411	3200	10,041	33,645	10000		

The total power "P" and the total torque "M" transmitted by the belt, are calculated with the following formulas:

$$P \text{ [Kw]} = P_{\text{spez}} \cdot Z_e \cdot Z_k \cdot b / 1000$$

$$M \text{ [Nm]} = M_{\text{spez}} \cdot Z_e \cdot Z_k \cdot b / 100$$

$$Z_e = \frac{Z_k \cdot \arccos \left[\frac{t \cdot (z_g - z_k)}{2 \cdot \pi \cdot A} \right]}{180}$$

P = power in Kw

M = torque in Nm

P_{spez} = specific power

M_{spez} = specific torque

Z_e = number of teeth in mesh of the small pulley

Z_{emax} = 12

Z_k = number of teeth of the small pulley

b = belt width in cm

A = centre distance [mm]

t = pitch

Flexibility

Minimum number of teeth and minimum diameter

Drive without reverse bending

- Timing pulley z_{min} = 28
- Idler running on belt teeth d_{min} = 120 mm

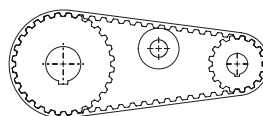

Drive with reverse bending and double sided belt

- Timing pulley z_{min} = 28
- Idler running on belt back d_{min} = 180 mm

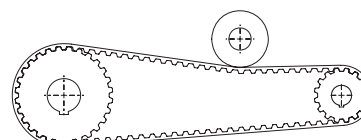

RTD5M ELA-flex SD™

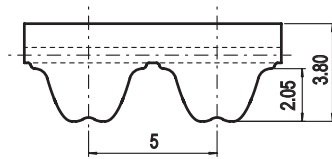
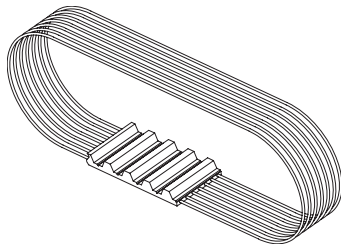

Belt characteristics

- Truly endless polyurethane timing belt with round tooth profile and steel tension cords. Produced according to ISO 13050
- Metric pitch 5 mm
- PAZ fabric on tooth delivered as standard decreases noise in high speed drives
- Transmissible power up to 6 kW
- Rpm up to 10.000 [1/min]
- Maximum width: 150 mm
- Width tolerance: ±0,5 [mm]
- Thickness tolerance: ±0,2 [mm]

Technical data

Belt width [mm]	10	15	25	50	100	150
Allowable tensile load [N]	920	1500	2650	5520	11100	16600
Weight [kg/m]	0,05	0,07	0,11	0,23	0,46	0,68

Other widths are available on request

Tooth shear strength

rpm [min ⁻¹]	M _{spez} [Ncm/cm]	P _{spez} [W/cm]	rpm [min ⁻¹]	M _{spez} [Ncm/cm]	P _{spez} [W/cm]	rpm [min ⁻¹]	M _{spez} [Ncm/cm]	P _{spez} [W/cm]
0	3,01	0,000	1200	2,15	2,703	3400	1,62	5,770
20	2,96	0,062	1300	2,11	2,878	3600	1,59	5,990
40	2,92	0,122	1400	2,08	3,048	3800	1,56	6,203
60	2,89	0,181	1440	2,07	3,115	4000	1,53	6,410
80	2,86	0,239	1500	2,05	3,214	4500	1,46	6,898
100	2,83	0,296	1600	2,01	3,375	5000	1,40	7,351
200	2,72	0,569	1700	1,98	3,533	5500	1,35	7,770
300	2,62	0,822	1800	1,96	3,687	6000	1,30	8,161
400	2,55	1,070	1900	1,93	3,838	6500	1,25	8,524
500	2,49	1,305	2000	1,90	3,985	7000	1,21	8,861
600	2,43	1,528	2200	1,85	4,271	7500	1,17	9,176
700	2,38	1,742	2400	1,81	4,545	8000	1,13	9,468
800	2,32	1,947	2600	1,77	4,808	8500	1,09	9,740
900	2,28	2,146	2800	1,73	5,062	9000	1,06	9,993
1000	2,23	2,337	3000	1,69	5,306	9500	1,03	10,228
1100	2,19	2,523	3200	1,65	5,542	10000	1,00	10,445

The total power "P" and the total torque "M" transmitted by the belt, are calculated with the following formulas:

$$P \text{ [Kw]} = P_{\text{spez}} \cdot Z_e \cdot Z_k \cdot b / 1000$$

$$M \text{ [Nm]} = M_{\text{spez}} \cdot Z_e \cdot Z_k \cdot b / 100$$

$$Z_e = \frac{Z_k}{180} \cdot \arccos \left[\frac{t \cdot (z_g - z_k)}{2 \cdot \pi \cdot A} \right]$$

P = power in Kw

M = torque in Nm

P_{spez} = specific power

M_{spez} = specific torque

Z_e = number of teeth in mesh of the small pulley

Z_emax = 12

Z_k = number of teeth of the small pulley

b = belt width in cm

A = centre distance [mm]

t = pitch

Flexibility

Minimum number of teeth and minimum diameter

Drive without reverse bending

• Timing pulley $z_{\min} = 16$

• Idler running on belt teeth $d_{\min} = 50 \text{ mm}$

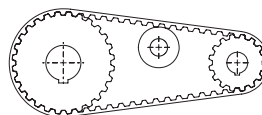

Drive with reverse bending and double sided belt

• Timing pulley $z_{\min} = 20$

• Idler running on belt back $d_{\min} = 50 \text{ mm}$

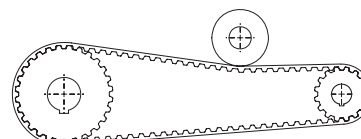

RTD8M ELA-flex SD™

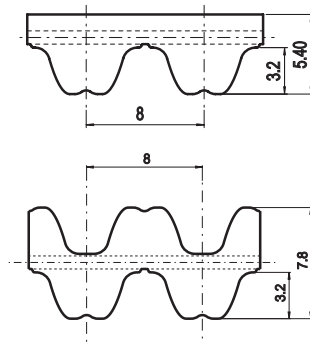
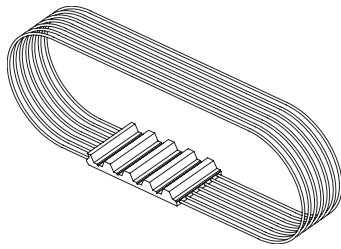

Belt characteristics

- Truly endless polyurethane timing belt with round tooth profile and steel tension cords. Produced according to ISO 13050
- Metric pitch 8 mm
- PAZ fabric on tooth delivered as standard decreases noise in high speed drives
- Transmissible power up to 80 kW
- Rpm up to 6.000 [1/min]
- Maximum width: 150 mm
- Width tolerance: ±0,5 [mm]
- Thickness tolerance: ±0,2 [mm]

Technical data

Belt width [mm]	10	15	20	30	50	85	100	150
Allowable tensile load [N]	1470	2210	3190	4900	8500	14500	16900	24900
Weight [kg/m]	0,07	0,10	0,13	0,20	0,33	0,56	0,66	1,00

Other widths are available on request

Tooth shear strength

rpm [min ⁻¹]	M _{spez} [Ncm/cm]	P _{spez} [W/cm]	rpm [min ⁻¹]	M _{spez} [Ncm/cm]	P _{spez} [W/cm]	rpm [min ⁻¹]	M _{spez} [Ncm/cm]	P _{spez} [W/cm]
0	9,68	0,000	1200	6,10	7,668	3400	4,19	14,920
20	9,50	0,199	1300	5,96	8,118	3600	4,08	15,381
40	9,34	0,391	1400	5,83	8,553	3800	3,98	15,818
60	9,19	0,577	1440	5,78	8,722	4000	3,88	16,232
80	9,05	0,758	1500	5,71	8,972	4500	3,64	17,175
100	8,92	0,934	1600	5,60	9,377	5000	3,44	17,996
200	8,41	1,762	1700	5,49	9,769	5500	3,25	18,708
300	8,11	2,547	1800	5,38	10,149	6000	3,08	19,320
400	7,77	3,255	1900	5,29	10,517	6500		
500	7,47	3,913	2000	5,19	10,873	7000		
600	7,21	4,532	2200	5,02	11,554	7500		
700	6,98	5,118	2400	4,85	12,197	8000		
800	6,77	5,674	2600	4,70	12,803	8500		
900	6,58	6,205	2800	4,56	13,377	9000		
1000	6,41	6,713	3000	4,43	13,919	9500		
1100	6,25	7,200	3200	4,31	14,433	10000		

The total power "P" and the total torque "M" transmitted by the belt, are calculated with the following formulas:

$$P \text{ [Kw]} = P_{\text{spez}} \cdot Z_e \cdot Z_k \cdot b / 1000$$

$$M \text{ [Nm]} = M_{\text{spez}} \cdot Z_e \cdot Z_k \cdot b / 100$$

$$Z_e = \frac{Z_k}{180} \cdot \arccos \left[\frac{t \cdot (z_g - z_k)}{2 \cdot \pi \cdot A} \right]$$

P = power in Kw

M = torque in Nm

P_{spez} = specific power

M_{spez} = specific torque

Z_e = number of teeth in mesh of the small pulley

Z_emax = 12

Z_k = number of teeth of the small pulley

b = belt width in cm

A = centre distance [mm]

t = pitch

Flexibility

Minimum number of teeth and minimum diameter

Drive without reverse bending

• Timing pulley $z_{\min} = 18$

• Idler running on belt teeth $d_{\min} = 50 \text{ mm}$

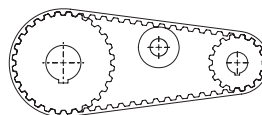

Drive with reverse bending and double sided belt

• Timing pulley $z_{\min} = 18$

• Idler running on belt back $d_{\min} = 120 \text{ mm}$

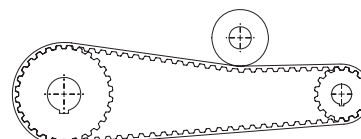

RTD14M ELA-flex SD™

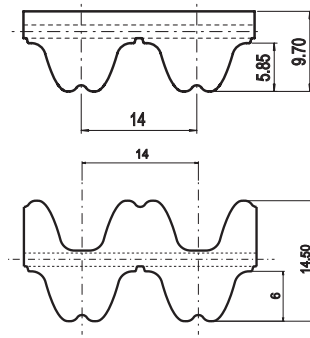
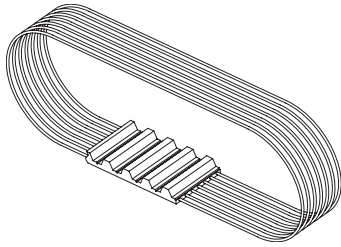

Belt characteristics

- Truly endless polyurethane timing belt with round tooth profile and steel tension cords. Produced according to ISO 13050
- Metric pitch 14 mm
- PAZ fabric on tooth delivered as standard decreases noise in high speed drives
- Transmissible power up to 200 kW
- Rpm up to 4.000 [1/min]
- Maximum width: 150 mm
- Width tolerance: ±1,0 [mm]
- Thickness tolerance: ±0,2 [mm]

Technical data

Belt width [mm]	40	55	85	115	150
Allowable tensile load [N]	12750	17850	27500	37100	46900
Weight [kg/m]	0,48	0,63	1,0	1,40	1,85

Other widths are available on request

Tooth shear strength

rpm [min ⁻¹]	M _{spez} [Ncm/cm]	P _{spez} [W/cm]	rpm [min ⁻¹]	M _{spez} [Ncm/cm]	P _{spez} [W/cm]	rpm [min ⁻¹]	M _{spez} [Ncm/cm]	P _{spez} [W/cm]
0	31,19	0,000	1200	18,56	23,325	3400	11,86	42,219
20	30,59	0,641	1300	18,08	24,611	3600	11,47	43,237
40	30,04	1,258	1400	17,63	25,840	3800	11,10	44,169
60	29,53	1,855	1440	17,45	26,316	4000	10,75	45,021
80	29,06	2,434	1500	17,20	27,016	4500		
100	28,62	2,997	1600	16,80	28,141	5000		
200	26,69	5,589	1700	16,42	29,220	5500		
300	25,47	8,000	1800	16,05	30,255	6000		
400	24,33	10,190	1900	15,71	31,249	6500		
500	23,32	12,209	2000	15,38	32,202	7000		
600	22,42	14,088	2200	14,76	33,998	7500		
700	21,62	15,849	2400	14,19	35,656	8000		
800	20,90	17,508	2600	13,66	37,187	8500		
900	20,24	19,076	2800	13,17	38,602	9000		
1000	19,64	20,564	3000	12,70	39,907	9500		
1100	19,08	21,978	3200	12,27	41,111	10000		

The total power "P" and the total torque "M" transmitted by the belt, are calculated with the following formulas:

$$P [\text{Kw}] = P_{\text{spez}} \cdot Z_e \cdot Z_k \cdot b / 1000$$

$$M [\text{Nm}] = M_{\text{spez}} \cdot Z_e \cdot Z_k \cdot b / 100$$

$$Z_e = \frac{Z_k \cdot \arccos \left[\frac{t \cdot (Z_g - Z_k)}{2 \cdot \pi \cdot A} \right]}{180}$$

P = power in Kw

M = torque in Nm

P_{spez} = specific power

M_{spez} = specific torque

Z_e = number of teeth in mesh of the small pulley

Z_{emax} = 12

Z_k = number of teeth of the small pulley

b = belt width in cm

A = centre distance [mm]

t = pitch

Flexibility

Minimum number of teeth and minimum diameter

Drive without reverse bending

- Timing pulley $Z_{\min} = 28$
- Idler running on belt teeth $d_{\min} = 120 \text{ mm}$

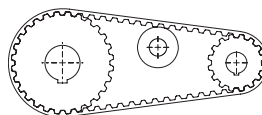

Drive with reverse bending and double sided belt

- Timing pulley $Z_{\min} = 28$
- Idler running on belt back $d_{\min} = 180 \text{ mm}$

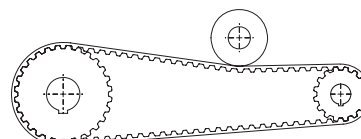

STD5M ELA-flex SD™

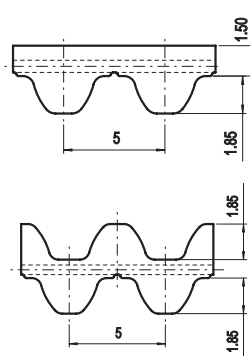
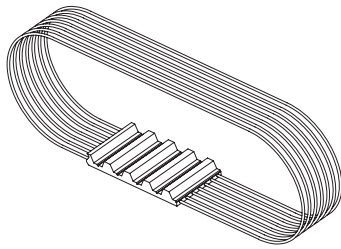

Belt characteristics

- Truly endless polyurethane timing belt with high tensile load steel cords and high torque capacity - produced according to ISO 13050
 - Metric pitch 5 mm
 - Low noise generation in high speed drives
 - Offer excellent operational reliability
 - The special profile allows smooth running properties
 - Transmissible power up to 6 Kw
 - Rpm up to 10.000 [1/min]
- Maximum width: 150 mm
 - Width tolerance: ±0,5 [mm]
 - Thickness tolerance: ±0,2 [mm]

Technical data

Belt width [mm]	10	15	25	50	100	150
Allowable tensile load [N]	1000	1500	2400	4800	9600	14300
Weight [kg/m]	0,046	0,068	0,114	0,228	0,456	0,684

Other widths are available on request

Tooth shear strength

rpm [min ⁻¹]	M _{spez} [Ncm/cm]	P _{spez} [W/cm]	rpm [min ⁻¹]	M _{spez} [Ncm/cm]	P _{spez} [W/cm]	rpm [min ⁻¹]	M _{spez} [Ncm/cm]	P _{spez} [W/cm]
0	2,936	0,000	1200	2,031	2,553	3400	1,501	5,345
20	2,892	0,061	1300	1,995	2,715	3600	1,470	5,540
40	2,853	0,119	1400	1,960	2,873	3800	1,440	5,728
60	2,817	0,177	1440	1,946	2,935	4000	1,411	5,910
80	2,784	0,233	1500	1,927	3,026	4500	1,345	6,336
100	2,755	0,288	1600	1,895	3,175	5000	1,285	6,726
200	2,645	0,554	1700	1,865	3,321	5500	1,230	7,083
300	2,497	0,784	1800	1,837	3,462	6000	1,180	7,411
400	2,435	1,020	1900	1,810	3,600	6500	1,133	7,711
500	2,372	1,242	2000	1,784	3,735	7000	1,090	7,987
600	2,313	1,453	2200	1,734	3,996	7500	1,049	8,238
700	2,257	1,654	2400	1,689	4,245	8000	1,011	8,469
800	2,205	1,847	2600	1,647	4,483	8500	0,975	8,678
900	2,157	2,033	2800	1,607	4,712	9000	0,941	8,868
1000	2,113	2,212	3000	1,570	4,931	9500	0,909	9,040
1100	2,071	2,385	3200	1,535	5,142	10000	0,878	9,195

The total power "P" and the total torque "M" transmitted by the belt, are calculated with the following formulas:

$$P \text{ [Kw]} = P_{\text{spez}} \cdot Z_e \cdot Z_k \cdot b / 1000$$

$$M \text{ [Nm]} = M_{\text{spez}} \cdot Z_e \cdot Z_k \cdot b / 100$$

$$Z_e = \frac{Z_k}{180} \cdot \arccos \left[\frac{t \cdot (z_g - z_k)}{2 \cdot \pi \cdot A} \right]$$

P = power in Kw

M = torque in Nm

P_{spez} = specific power

M_{spez} = specific torque

Z_e = number of teeth in mesh of the small pulley

Z_{emax} = 12

Z_k = number of teeth of the small pulley

b = belt width in cm

A = centre distance [mm]

t = pitch

Flexibility

Minimum number of teeth and minimum diameter

Drive without reverse bending

- Timing pulley $z_{\min} = 16$
- Idler running on belt teeth $d_{\min} = 50 \text{ mm}$

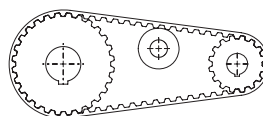

Drive with reverse bending and double sided belt

- Timing pulley $z_{\min} = 20$
- Idler running on belt back $d_{\min} = 50 \text{ mm}$

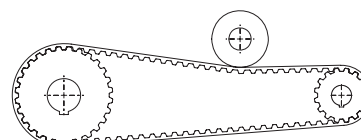

STD8M ELA-flex SD™

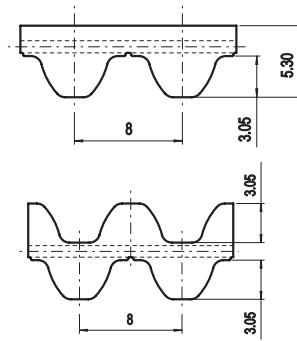
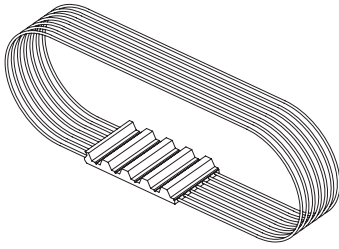

Belt characteristics

- Truly endless polyurethane timing belt with high tensile load steel cords and high torque capacity - produced according to ISO 13050
 - Metric pitch 8 mm
 - Low noise generation in high speed drives
 - Offer excellent operational reliability
 - The special profile allows smooth running properties
 - Transmissible power up to 80 Kw
 - Rpm up to 6.000 [1/min]
- Maximum width: 150 mm
 - Width tolerance: $\pm 0,5$ [mm]
 - Thickness tolerance: $\pm 0,2$ [mm]

Technical data

Belt width [mm]	10	15	20	30	50	85	100	150
Allowable tensile load [N]	1470	2210	3190	4660	8580	14700	17400	26000
Weight [kg/m]	0,07	0,10	0,13	0,20	0,33	0,56	0,66	1,00

Other widths are available on request

Tooth shear strength

rpm [min ⁻¹]	M _{spez} [Ncm/cm]	P _{spez} [W/cm]	rpm [min ⁻¹]	M _{spez} [Ncm/cm]	P _{spez} [W/cm]	rpm [min ⁻¹]	M _{spez} [Ncm/cm]	P _{spez} [W/cm]
0	9,435	0,000	1200	5,885	7,394	3400	3,960	14,098
20	9,301	0,195	1300	5,745	7,821	3600	3,849	14,508
40	9,176	0,384	1400	5,615	8,231	3800	3,743	14,894
60	9,057	0,569	1440	5,565	8,391	4000	3,643	15,257
80	8,946	0,749	1500	5,492	8,626	4500	3,410	16,070
100	8,841	0,926	1600	5,376	9,007	5000	3,201	16,762
200	8,401	1,759	1700	5,266	9,374	5500	3,011	17,343
300	7,908	2,484	1800	5,162	9,729	6000	2,837	17,824
400	7,567	3,169	1900	5,063	10,072	6500		
500	7,268	3,805	2000	4,968	10,404	7000		
600	7,005	4,401	2200	4,790	11,035	7500		
700	6,772	4,963	2400	4,627	11,628	8000		
800	6,561	5,496	2600	4,475	12,184	8500		
900	6,370	6,003	2800	4,334	12,707	9000		
1000	6,195	6,487	3000	4,202	13,199	9500		
1100	6,034	6,950	3200	4,077	13,662	10000		

The total power "P" and the total torque "M" transmitted by the belt, are calculated with the following formulas:

$$P \text{ [Kw]} = P_{\text{spez}} \cdot Z_e \cdot Z_k \cdot b / 1000$$

$$M \text{ [Nm]} = M_{\text{spez}} \cdot Z_e \cdot Z_k \cdot b / 100$$

$$Z_e = \frac{Z_k}{180} \cdot \arccos \left[\frac{t \cdot (z_g - z_k)}{2 \cdot \pi \cdot A} \right]$$

P = power in Kw

M = torque in Nm

P_{spez} = specific power

M_{spez} = specific torque

Z_e = number of teeth in mesh of the small pulley

Z_{emax} = 12

Z_k = number of teeth of the small pulley

b = belt width in cm

A = centre distance [mm]

t = pitch

Flexibility

Minimum number of teeth and minimum diameter

Drive without reverse bending

- Timing pulley $z_{\min} = 18$
- Idler running on belt teeth $d_{\min} = 50$ mm

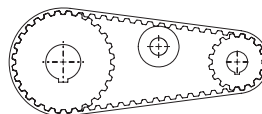

Drive with reverse bending and double sided belt

- Timing pulley $z_{\min} = 18$
- Idler running on belt back $d_{\min} = 120$ mm

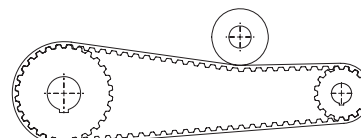

STD14M ELA-flex SD™

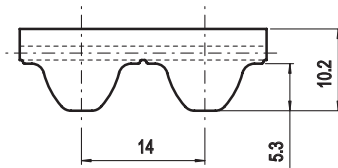
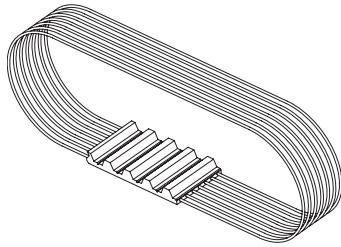

Belt characteristics

- Truly endless polyurethane timing belt with high tensile load steel cords and high torque capacity - produced according to ISO 13050
 - Metric pitch 14 mm
 - Low noise generation in high speed drives
 - Offer excellent operational reliability
 - The special profile allows smooth running properties
 - Transmissible power up to 80 Kw
 - Rpm up to 4.000 [1/min]
- Maximum width: 150 mm
 - Width tolerance: ±0,5 [mm]
 - Thickness tolerance: ±0,2 [mm]

Technical data

Belt width [mm]	40	55	85	115	150
Allowable tensile load [N]	12750	17850	28050	38250	49500
Weight [kg/m]	0,48	0,85	1,10	1,40	2,0

Other widths are available on request

Tooth shear strength

rpm [min ⁻¹]	M _{spez} [Ncm/cm]	P _{spez} [W/cm]	rpm [min ⁻¹]	M _{spez} [Ncm/cm]	P _{spez} [W/cm]	rpm [min ⁻¹]	M _{spez} [Ncm/cm]	P _{spez} [W/cm]
0	29,86	0,000	1200	17,45	21,925	3400	10,74	38,252
20	29,26	0,613	1300	16,97	23,095	3600	10,36	39,037
40	28,70	1,202	1400	16,51	24,207	3800	9,99	39,736
60	28,19	1,771	1440	16,34	24,636	4000	9,63	40,354
80	27,72	2,322	1500	16,09	25,266	4500		
100	27,29	2,857	1600	15,68	26,275	5000		
200	25,57	5,355	1700	15,30	27,237	5500		
300	24,35	7,650	1800	14,94	28,156	6000		
400	23,21	9,723	1900	14,59	29,032	6500		
500	22,20	11,626	2000	14,26	29,869	7000		
600	21,31	13,388	2200	13,64	31,431	7500		
700	20,51	15,032	2400	13,07	32,856	8000		
800	19,79	16,575	2600	12,55	34,154	8500		
900	19,13	18,026	2800	12,05	35,335	9000		
1000	18,52	19,397	3000	11,59	36,408	9500		
1100	17,97	20,695	3200	11,15	37,378	10000		

The total power "P" and the total torque "M" transmitted by the belt, are calculated with the following formulas:

$$P \text{ [Kw]} = P_{\text{spez}} \cdot Z_e \cdot Z_k \cdot b / 1000$$

$$M \text{ [Nm]} = M_{\text{spez}} \cdot Z_e \cdot Z_k \cdot b / 100$$

$$Z_e = \frac{Z_k}{180} \cdot \arccos \left[\frac{t \cdot (z_g - z_k)}{2 \cdot \pi \cdot A} \right]$$

P = power in Kw

M = torque in Nm

P_{spez} = specific power

M_{spez} = specific torque

Z_e = number of teeth in mesh of the small pulley

Z_{emax} = 12

Z_k = number of teeth of the small pulley

b = belt width in cm

A = centre distance [mm]

t = pitch

Flexibility

Minimum number of teeth and minimum diameter

Drive without reverse bending

- Timing pulley $z_{\min} = 18$
- Idler running on belt teeth $d_{\min} = 50 \text{ mm}$

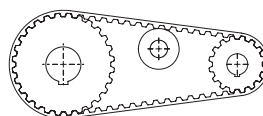

Drive with reverse bending and double sided belt

- Timing pulley $z_{\min} = 18$
- Idler running on belt back $d_{\min} = 120 \text{ mm}$

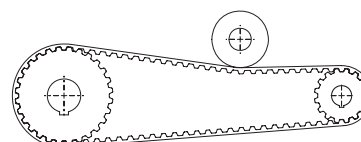

EAGLE 8M ELA-flex SD™

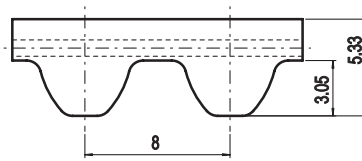
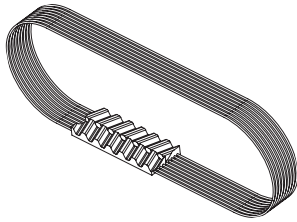

Belt characteristics

- Truly endless polyurethane timing belt with helical offset tooth, high tensile load steel cords and high torque capacity.
 - **Self tracking no need of pulley flanges**
 - Metric pitch 8 mm
 - **Extremely reduced noise generation**
 - The special profile allows most compact drive
- Width tolerance: $\pm 0,8$ [mm]
 - Thickness tolerance: $\pm 0,3$ [mm]

Technical data

Belt width [mm]	16	25	32	50
Allowable tensile load [N]	2450	4170	5390	8590
Weight [kg/m]	0,085	0,145	0,180	0,300

Tooth shear strength

rpm [min ⁻¹]	M _{spez} [Ncm/cm]	P _{spez} [W/cm]	rpm [min ⁻¹]	M _{spez} [Ncm/cm]	P _{spez} [W/cm]	rpm [min ⁻¹]	M _{spez} [Ncm/cm]	P _{spez} [W/cm]
0	10,82	0,000	1200	6,87	8,631	3400	4,90	16,422
20	10,67	0,223	1300	6,72	9,146	3600	4,77	16,991
40	10,52	0,441	1400	6,58	9,642	3800	4,65	17,531
60	10,38	0,652	1440	6,52	9,836	4000	4,53	18,044
80	10,24	0,858	1500	6,44	10,122	4500	4,42	18,531
100	10,11	1,058	1600	6,32	10,585	5000	4,17	19,647
200	9,52	1,994	1700	6,20	11,035	5500	3,94	20,627
300	9,04	2,840	1800	6,09	11,470	6000	3,73	21,486
400	8,65	3,623	1900	5,98	11,892	6500	3,54	22,234
500	8,34	4,368	2000	5,87	12,302			
600	8,07	5,068	2200	5,68	13,087			
700	7,82	5,732	2400	5,50	13,828			
800	7,60	6,363	2600	5,34	14,529			
900	7,39	6,966	2800	5,18	15,194			
1000	7,20	7,543	3000	5,12	15,450			
1100	7,03	8,098	3200	5,04	15,824			

The total power "P" and the total torque "M" transmitted by the belt, are calculated with the following formulas:

$$P \text{ [Kw]} = P_{\text{spez}} \cdot Z_e \cdot Z_k \cdot b / 1000$$

$$M \text{ [Nm]} = M_{\text{spez}} \cdot Z_e \cdot Z_k \cdot b / 100$$

$$Z_e = \frac{Z_k}{180} \cdot \arccos \left[\frac{t \cdot (z_g - z_k)}{2 \cdot \pi \cdot A} \right]$$

- P = power in Kw
- M = torque in Nm
- P_{spez} = specific power
- M_{spez} = specific torque
- Z_e = number of teeth in mesh of the small pulley
- Z_{max} = 12
- Z_k = number of teeth of the small pulley
- b = belt width in cm
- A = centre distance [mm]
- t = pitch

Flexibility

Minimum number of teeth and minimum diameter

Drive without reverse bending

- Timing pulley $z_{\min} = 20$
- Idler running on belt teeth $d_{\min} = 50$ mm

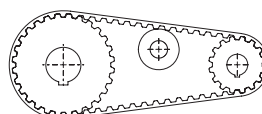

Drive with reverse bending and double sided belt

- Timing pulley $z_{\min} = 20$
- Idler running on belt back $d_{\min} = 100$ mm

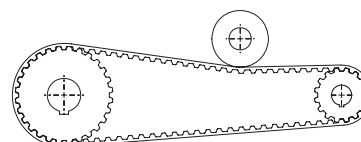

EAGLE 14M ELA-flex SD™

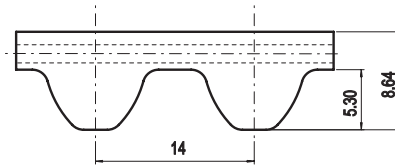
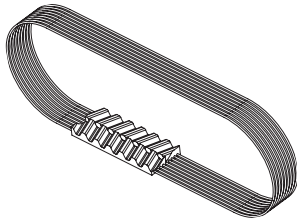

Belt characteristics

- Truly endless polyurethane timing belt with helical offset tooth, high tensile load steel cords and high torque capacity.
 - **Self tracking no need of pulley flanges**
 - Metric pitch 14 mm
 - **Extremely reduced noise generation**
 - The special profile allows most compact drive
- Width tolerance: $\pm 1,2$ [mm]
 - Thickness tolerance: $\pm 0,4$ [mm]

Technical data

Belt width [mm]	35	52,5	70	105
Allowable tensile load [N]	11050	17000	22950	34850
Weight [kg/m]	0,4	0,6	0,8	1,2

Tooth shear strength

rpm [min ⁻¹]	M _{spez} [Ncm/cm]	P _{spez} [W/cm]	rpm [min ⁻¹]	M _{spez} [Ncm/cm]	P _{spez} [W/cm]	rpm [min ⁻¹]	M _{spez} [Ncm/cm]	P _{spez} [W/cm]
0	35,65	0,000	1200	20,07	25,222	3200	12,19	40,849
20	34,98	0,733	1300	19,46	26,495	3400	11,68	41,581
40	34,36	1,439	1400	18,89	27,698	3600	11,19	42,201
60	33,79	2,123	1440	18,68	28,160	3800	10,73	42,715
80	33,25	2,786	1500	18,36	28,834	4000	10,30	43,129
100	32,76	3,430	1600	17,85	29,909			
200	30,76	6,441	1700	17,37	30,926			
300	28,94	9,090	1800	16,92	31,888			
400	27,43	11,491	1900	16,49	32,798			
500	26,12	13,677	2000	16,07	33,659			
600	24,97	15,689	2200	15,30	35,243			
700	23,95	17,553	2400	14,59	36,656			
800	23,03	19,290	2600	13,93	37,912			
900	22,19	20,915	2800	13,31	39,023			
1000	21,43	22,439	2880	13,07	39,429			
1100	20,73	23,872	3000	12,73	39,999			

The total power "P" and the total torque "M" transmitted by the belt, are calculated with the following formulas:

$$P \text{ [Kw]} = P_{\text{spez}} \cdot Z_e \cdot Z_k \cdot b / 1000$$

$$M \text{ [Nm]} = M_{\text{spez}} \cdot Z_e \cdot Z_k \cdot b / 100$$

$$Z_e = \frac{Z_k}{180} \cdot \arccos \left[\frac{t \cdot (z_g - z_k)}{2 \cdot \pi \cdot A} \right]$$

P = power in Kw

M = torque in Nm

P_{spez} = specific power

M_{spez} = specific torque

Z_e = number of teeth in mesh of the small pulley

Z_{emax} = 12

Z_k = number of teeth of the small pulley

b = belt width in cm

A = centre distance [mm]

t = pitch

Flexibility

Minimum number of teeth and minimum diameter

Drive without reverse bending

- Timing pulley $z_{\min} = 32$
- Idler running on belt teeth $d_{\min} = 160$ mm

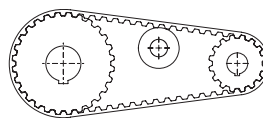

Drive with reverse bending and double sided belt

- Timing pulley $z_{\min} = 32$
- Idler running on belt back $d_{\min} = 250$ mm

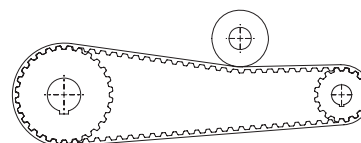

ATK10 - K6 ELA-flex SD™

Belt characteristics

- Polyurethane self track timing belt with steel tension cords
- Profile AT10 with central guide
- Central guide height 4 mm
- Allow to use pulleys without flanges
- The central guide is notched in order to maximize belt flexibility
- Ideal for conveying applications where a side load is generated by loading/unloading transferring a product

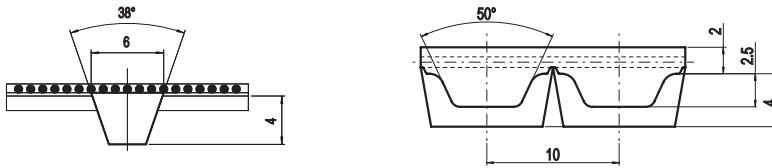

Technical data

Belt width [mm]	32	50
Allowable tensile load type V [N]	5100	7900
Weight [kg]	0,27	0,36

Other widths are available on request

Tooth shear strength

rpm [min ⁻¹]	M _{spez} [Ncm/cm]	P _{spez} [W/cm]	rpm [min ⁻¹]	M _{spez} [Ncm/cm]	P _{spez} [W/cm]	rpm [min ⁻¹]	M _{spez} [Ncm/cm]	P _{spez} [W/cm]
0	12,048	0,000	1200	7,708	9,685	3400	5,317	18,931
20	11,871	0,249	1300	7,534	10,256	3600	5,180	19,529
40	11,706	0,490	1400	7,372	10,807	3800	5,048	20,088
60	11,550	0,726	1440	7,310	11,022	4000	4,924	20,625
80	11,403	0,955	1500	7,219	11,339	4500	4,636	21,846
100	11,265	1,180	1600	7,076	11,855	5000	4,377	22,915
200	10,684	2,238	1700	6,939	12,352	5500	4,140	23,841
300	10,215	3,209	1800	6,810	12,836	6000	3,923	24,648
400	9,793	4,102	1900	6,688	13,305	6500	3,724	25,348
500	9,424	4,934	2000	6,570	13,759	7000	3,538	25,933
600	9,097	5,716	2200	6,349	14,625	7500	3,365	26,423
700	8,808	6,456	2400	6,147	15,447	8000	3,202	26,825
800	8,547	7,159	2600	5,959	16,223	8500	3,048	27,127
900	8,309	7,831	2800	5,782	16,953	9000	2,903	27,358
1000	8,093	8,474	3000	5,618	17,649	9500	2,766	27,516
1100	7,893	9,091	3200	5,464	18,308	10000	2,636	27,598

The total power "P" and the total torque "M" transmitted by the belt, are calculated with the following formulas:

$$P \text{ [Kw]} = P_{\text{spez}} \cdot Z_e \cdot Z_k \cdot b / 1000$$

$$M \text{ [Nm]} = M_{\text{spez}} \cdot Z_e \cdot Z_k \cdot b / 100$$

$$Z_e = \frac{Z_k}{180} \cdot \arccos \left[\frac{t \cdot (z_g - z_k)}{2 \cdot \pi \cdot A} \right]$$

P = power in Kw

M = torque in Nm

P_{spez} = specific power

M_{spez} = specific torque

Z_e = number of teeth in mesh of the small pulley

Z_emax = 12

Z_k = number of teeth of the small pulley

b = belt width in cm

A = centre distance [mm]

t = pitch

Flexibility

Minimum number of teeth and minimum diameter

Drive without reverse bending

• Timing pulley z_{min} = 25

• Idler running on belt teeth d_{min} = 80 mm

Drive with reverse bending

• Timing pulley z_{min} = 25

• Idler running on belt back d_{min} = 120 mm

F2

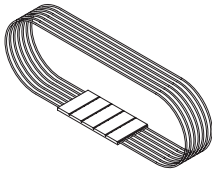

Belt characteristics

- Polyurethane flat belt with steel tension cords
- It is mainly used in drive applications where there is no need for synchronization
- Allows the use of small diameter pulleys
- Width tolerance: $\pm 0,5$ [mm]
- Thickness tolerance: $\pm 0,2$ [mm]

Technical data

Belt width [mm]	25	32	50	75	100
Allowable tensile load [N]	1800	2320	3860	5900	7900
Weight [kg/m]	0,007	0,1	0,16	0,24	0,3

Other widths are available on request

Flexibility

Minimum pulley diameter

Minimum pulley diameter $d_{\min} = 50$ mm

Drive without reverse bending

- Idler running inside belt $d_{\min} = 50$ mm

Drive with reverse bending

- Idler running on belt back $d_{\min} = 100$ mm

F4

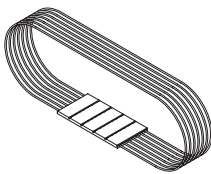

Belt characteristics

- Polyurethane flat belt with steel tension cords
- It is mainly used in drive applications where there is no need of synchronization
- Allows the use of small diameter pulleys
- Width tolerance: $\pm 1,0$ [mm]
- Thickness tolerance: $\pm 0,2$ [mm]

Technical data

Belt width [mm]	25	50	75	100
Allowable tensile load [N]	4200	8400	12600	16800
Weight [kg/m]	0,2	0,4	0,6	0,8

Other widths are available on request.

Flexibility

Minimum pulley diameter

Minimum pulley diameter $d_{\min} = 120$ mm

Drive without reverse bending

- Idler running inside belt $d_{\min} = 120$ mm

Drive with reverse bending

- Idler running on belt back $d_{\min} = 150$ mm

Drive calculation

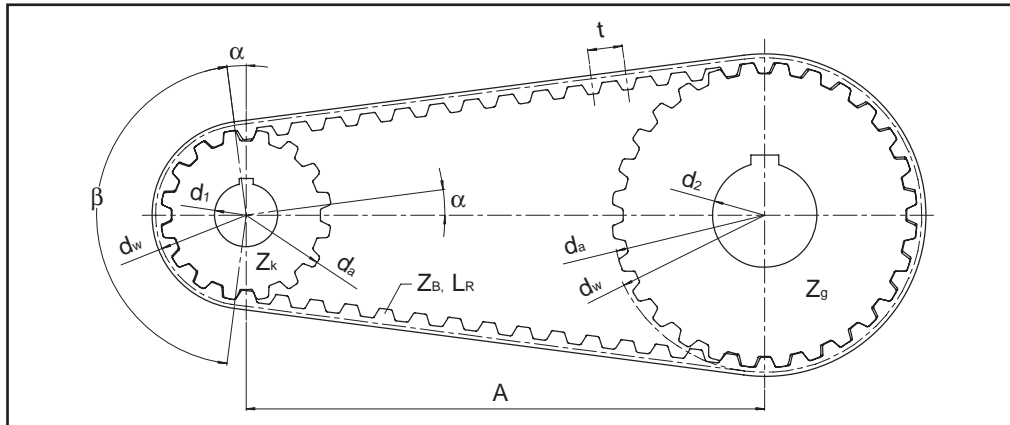

Definitions

b	(cm)	Belt width	F_U	(N)	Peripheral force
L_R	(mm)	Belt length	M	(Nm)	Torque
Z_R	-	Number of teeth of the belt	P	(kW)	Power
B	(mm)	Pulley width	t_{ab}	(s)	Acceleration time
A	(mm)	Center distance	t_{av}	(s)	Deceleration time
A_{eff}	(mm)	Effective center distance	v	(m/s)	Peripheral speed
d	(mm)	Pulley bore diameter	Z_e	-	N. of teeth in mesh
d_a	(mm)	Pulley outside diameter	Z_k	-	Number of teeth of the small pulley
d_{ak}	(mm)	Small pulley outside diameter	Z_g	-	Number of teeth of the large pulley
d_{ag}	(mm)	Large pulley outside diameter	i	-	Drive ratio ($n_1 : n_2$)
d_w	(mm)	Pulley pitch diameter	ρ	(kg/dm ³)	Specific weight
d_{wk}	(mm)	Small pulley pitch circle diameter	J	(kgm ²)	Moment of inertia
d_{wg}	(mm)	Large pulley pitch circle diameter	t	(mm)	Pitch
F_{Wsta}	(N)	Static Shafts load	n	(min ⁻¹)	Rpm
F_{TV}	(N)	Pretension force per belt side	n_1	(min ⁻¹)	Rpm of driver pulley
F_{Tzul}	(N)	Allowable tensile load	ω	(s ⁻¹)	Angular speed
			β	(°)	Wrap angle

Calculation formula

Power

$$P = \frac{M \cdot n}{9550}$$

$$P = \frac{F_u \cdot d_w \cdot n}{19100 \cdot 10^3}$$

Peripheral force

$$F_u = \frac{19100 \cdot P \cdot 10^3}{n \cdot d_w}$$

$$F_u = \frac{2000 \cdot M}{d_w}$$

Torque

$$M = \frac{F_u \cdot d_w}{2000}$$

$$M = \frac{P \cdot 9550}{n}$$

Angular speed

$$\omega = \frac{\pi \cdot n}{30}$$

peripheral speed

$$v = \frac{d_w \cdot n}{19100}$$

Acceleration torque

$$M_{ab} = \frac{J \cdot \Delta n}{9,55 \cdot t_{ab}}$$

Moment of inertia

$$J = 98,2 \cdot 10^{-15} \cdot B \cdot \rho \cdot (d_a^4 - d^4)$$

rpm

$$n = \frac{19100 \cdot v}{d_w}$$

Safety factors

Belt selection is made according to a constant working load. In case of peak loads and vibrations a safety factor c_1 must be considered.

Transmission with steady load $c_1 = 1,0$

Transmission with peak or fluctuating loads:

Light	$c_1 = 1,4$
Medium	$c_1 = 1,7$
Heavy	$c_1 = 2,0$

For speed up driver factor c_2 must be considered:

$i =$ from 0,66 to 1	$c_2 = 1,1$
$i =$ from 0,40 to 0,66	$c_2 = 1,2$
$i < 0,40$	$c_2 = 1,3$

The resulting total safety factor is:

$$c_0 = c_1 \cdot c_2$$

Drive calculation

The necessary data for drive calculation are:

• Power to be transmitted	P	[kW]
• Driver rpm	n_1	[min ⁻¹]
• Motor starting torque	M_{ab}	[Nm]
• Required center distance	A	[mm]
• Maximum driver pulley diameter	d_{w1}	[mm]

Select type of belt

For the initial drive selection, use the selection graphs illustrated in the relative ELA-flex SD™ catalogue section. For initial pulley choice, it is recommended to use the driver pulley with maximum diameter allowable in the application.

Calculate drive ratio

$$i = \frac{n_{driver}}{n_{driven}}$$

Calculate belt length

Belt length for drive with ratio $i \neq 1$

$$L_R \approx \frac{t}{2} \cdot (z_g + z_k) + 2A + \frac{1}{4A} \cdot \left[\frac{(z_g - z_k) \cdot t}{\pi} \right]^2$$

and more precisely:

$$L_R = 2A \cdot \sin \frac{\beta}{2} + \frac{t}{2} \cdot \left[z_g + z_k + \left(1 - \frac{\beta}{180} \right) \cdot (z_g - z_k) \right]$$

Belt length for drive with ratio $i = 1$

$$L_R = 2 \cdot A + \pi \cdot d_w = 2 \cdot A + z \cdot t$$

Calculate teeth in mesh

$$z_e = \frac{\beta}{360} \cdot z_k$$

with $\beta [^\circ] =$ wrap angle

$$\beta = 2 \cdot \arccos \left[\frac{t \cdot (z_g - z_k)}{2 \cdot \pi \cdot A} \right]$$

Determine belt width

$$b = \frac{P \cdot 1000 \cdot c_0}{z_k \cdot z_e \cdot P_{spez}} \quad b = \frac{100 \cdot M \cdot c_0}{z_k \cdot z_e \cdot M_{spez}}$$

Verify allowable tensile load

The allowable tensile load of the belt must be higher than the total corrected peripheral force.

$$F_{Tzul} > c_0 \cdot F_U \quad \text{with} \quad F_U = \frac{2000 \cdot M}{d_w}$$

Calculate shaft load

$$F_{Wsta} = 2 \cdot F_{TV} \cdot \cos \beta$$

$$F_{Wsta} = 2 \cdot F_{TV} \quad (\text{for } i = 1)$$

Determine installation tension

A drive is correctly tensioned when the belt slack side is tensioned in all working conditions. It is also important to use the minimum necessary tension to minimize shaft loads. Belt tension is dependent also on belt length L_R and its number of teeth Z_R . According to belt number of teeth, following tension is suggested:

2 shafts drive

$Z_R < 75$	$F_{TV} = 1/3 F_U$
$75 < Z_R < 150$	$F_{TV} = 1/2 F_U$
$Z_R > 150$	$F_{TV} = 2/3 F_U$

More than 2 shafts drive

$$F_{TV} > F_U$$

In order to ensure the correct drive installation tension, it is recommended to use the special belt tension meter available from ELATECH®.

Calculation example

- Power to be transmitted	20 Kw
- Driver rpm n_1	1500 1/min
- Driven rpm n_2	1500 1/min
- Motor torque M	250 Nm
- Required center distance A	1800 mm
- Max allowable driver pulley diameter d_w	150 mm
- Safety factor c_1	1,4

Calculate drive ratio

$$\frac{n_1}{n_2} = 1$$

Select belt type and pitch

From HTD selection graphs and the corrected power of 28 Kw, a 8M pitch is chosen.

Calculate pulley diameter

From the maximum allowable pulleys diameter, the drive ratio and the type of belt selected, the number of teeth of the driver and driven pulley is calculated.

$$z = \frac{150 \cdot \pi}{8} = 58,9 - \text{select } z = 56 \text{ with } d_w = 142,60 \text{ mm}$$

The maximum allowable diameter is chosen to minimize belt width.

$$z_1 = 56$$

$$z_2 = 56$$

Calculate belt length

$$L_R = 2 \cdot A + \pi \cdot d_w = 2 \cdot A + z \cdot t$$

$$L_R = 2 \cdot 1800 + 56 \cdot 8 = 4048 \text{ mm}$$

Calculate teeth in mesh

Being the drive ratio 1, the pulleys have 28 teeth in mesh.

$$z_e = 28$$

Calculate belt width

$$b = \frac{1000 \cdot 20 \cdot 1,4}{56 \cdot 12 \cdot 8,572} = 4,86 \text{ cm} = 48,6 \text{ mm}$$

A belt width of 50 mm is selected .

The belt width is verified according to the peak torque (starting torque) for $n = 0$ with $1,4 \times 250$ Nm as start up torque

$$b = \frac{100 \cdot 350}{56 \cdot 12 \cdot 9,422} = 5,53 \text{ cm} = 55 \text{ mm}$$

The next belt width 85 mm is chosen.

Verify allowable tensile load

$$F_U = \frac{2000 \cdot 350}{142,6} = 4908,83 \text{ N}$$

Determine installation tension according to belt number of teeth

$$z_R = \frac{4048}{8} = 506 \text{ teeth}$$

The installation tension per belt side F_{TV} is therefore:

$$F_{TV} = \frac{2}{3} \cdot F_U = 3272,55 \text{ N with } z_R = 506 > 150$$

From the technical data for ELA-flex SD™ belts HTD 8M, the maximum allowable tensile load for belt width 85 mm is: 13400 N.

$$F_{Tzul} = 13400 \text{ N} > F_{TV} + F_U = 3272,55 + 4908,83 = 8181,38 \text{ N}$$

Verify flexibility

The minimum pulley diameters are respected.

Selected belt

ELA-flex SD™ 85HTD8M 4048

Selection graphs

The selection graphs enable to select the most suitable timing belt pitch, for each belt profile, for the power to be transmitted. The rpm on the horizontal axis refers to the small pulley. The corrected power (safety factor x nominal power) is read on the vertical axis.

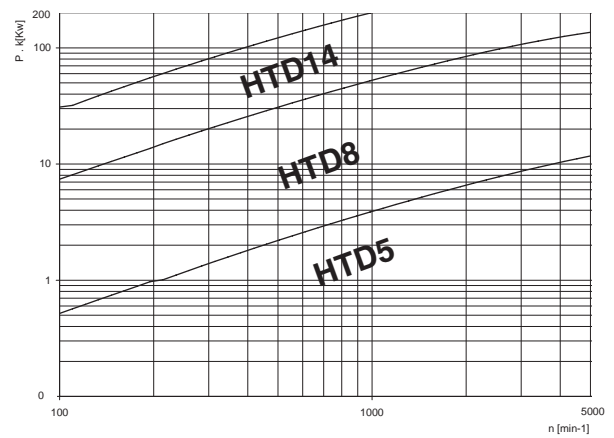
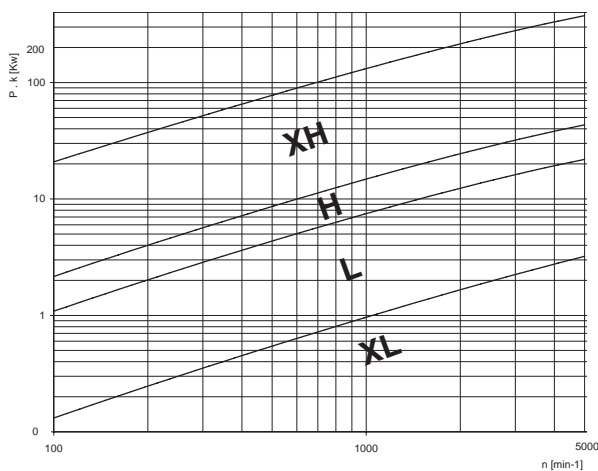
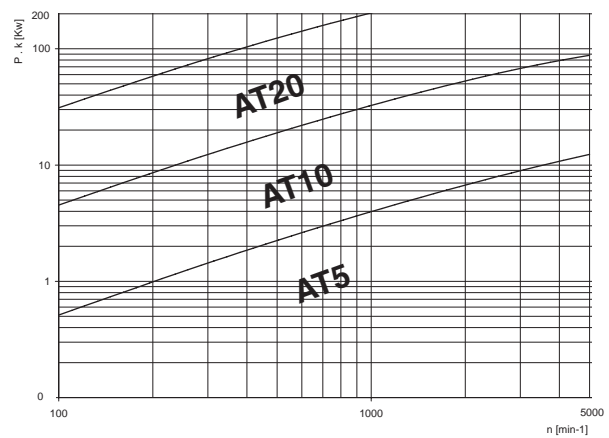
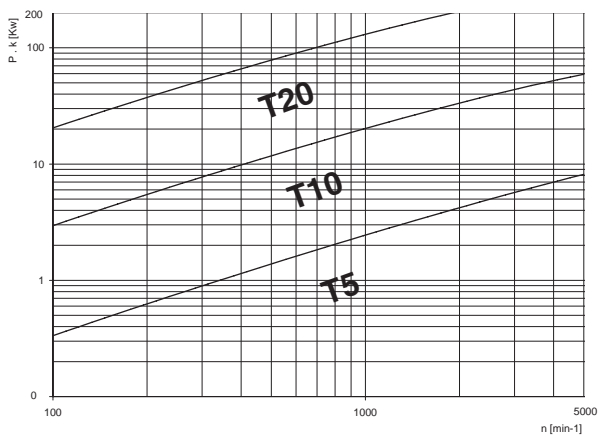

The selection graphs enable to select the most suitable timing belt pitch, for each belt profile, for the power to be transmitted. The rpm on the horizontal axis refers to the small pulley. The corrected power (safety factor x nominal power) is read on the vertical axis.

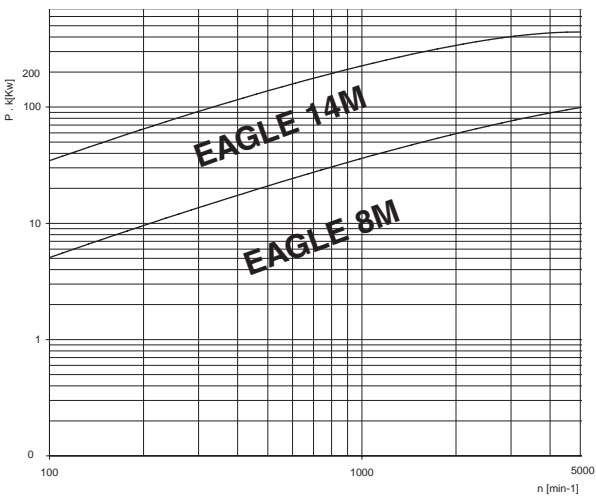
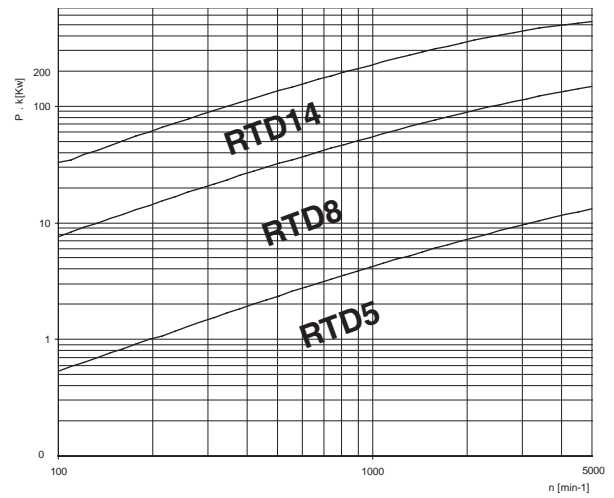
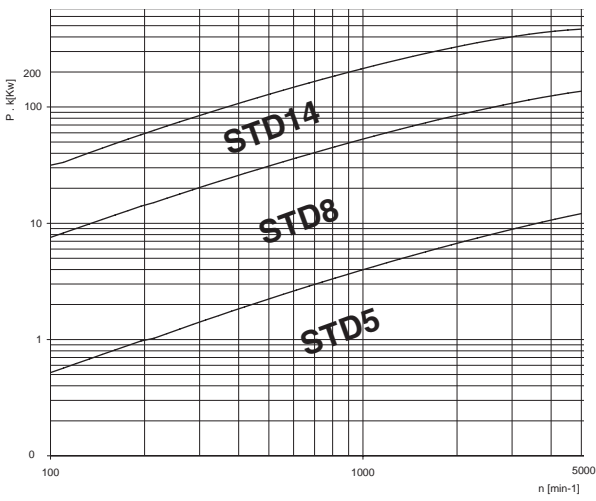

Polyurethane belts for conveying applications

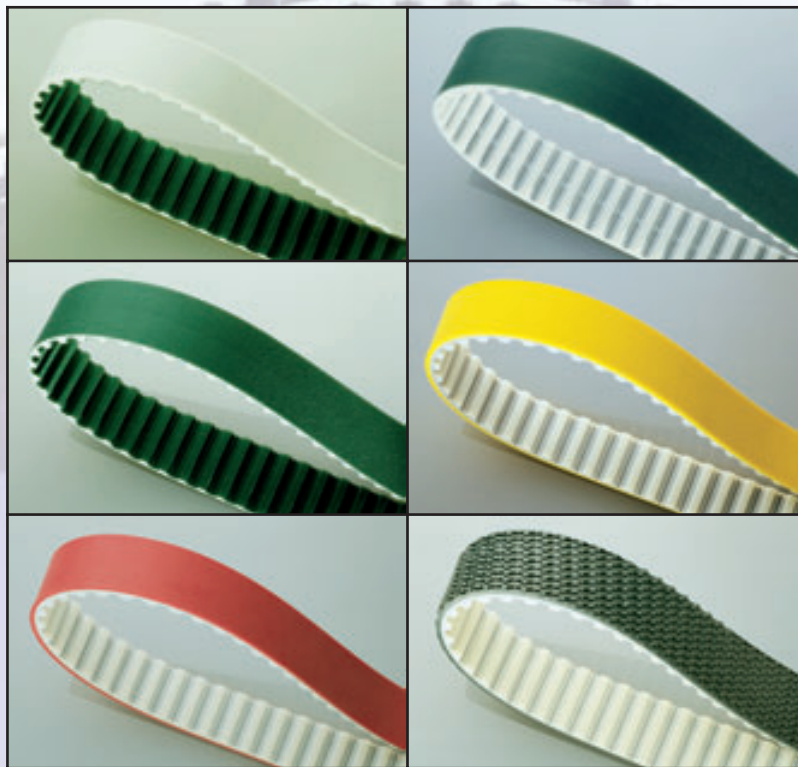

Polyurethane belts for conveying applications

The unique chemical and mechanical characteristics of ELATECH® belts together with the possibility of a wide variety of backings in different materials make ELATECH® belts ideal for all conveying applications where synchronization is required. The engineer designer has unlimited possibilities to make unique designs.

Minimum pulley diameter

The recommended minimum pulley diameter can be calculated using the “pulley multiplier” shown for each type of backing

Minimum pulley diameter = backing thickness x pulley multiplier C_D

The diameters obtained are valid for application with speed up to 1m/s and temperature of 20° C. When smaller pulley diameter are needed please consult with Elatech technical department.

Drive with reverse bending

ELATECH® polyurethane timing belts are suitable for drives with reverse bending. Tension should be adjusted, depending on backing hardness.

Temperature

Hot items may be conveyed when a correct backing is selected. In such a case, ensure that the belt toothed structure does not over come 80° C.

Polyamide fabric backings

The special polyamide fabric backings allow a reduction of the friction coefficient and when applied on teeth, decrease noise in high speed drives. They are very useful in applications with sliding surfaces or product accumulation.

PAZ: Polyamide backing on tooth side
Reduces coefficient of friction and allows a smother tooth engagement.

PAR: Polyamide backing on back side
Reduces coefficient of friction.

PAZ-PAR: Polyamide backing on both tooth and back side

Coefficient of friction

- Polyurethane on steel $\mu = 0,7$
- Polyammide on steel $\mu = 0,35$

	PAZ	PAR	PAZ-PAR
	Tooth facing fabric	Nylon fabric on the belt back	Nylon fabric on tooth facing and on belt back
Material	Polyamide	Polyamide	Polyamide
Color	Green	Green	Green
Mechanical characteristics	Low coefficient of friction	Low coefficient of friction	Low coefficient of friction
Chemical properties	Moderate resistance to oils and greases	Moderate resistance to oils and greases	Moderate resistance to oils and greases

Polyurethane film backing (foil)

Among all synthetic materials and rubber compounds, polyurethane is the material which offers the best resistance to abrasion. Polyurethane films of different thickness and different shore hardness, applied on ELATECH® belts, are an ideal solution in many applications in the wood processing, ceramic and glass industry. On request it is possible to supply polyurethane backings FDA approved.

Pulley diameter: C_D • Backing Thickness

	PUR 85	PUR 70	PUR 85 FISHBONE
Material	TPU	TPU	TPU
Color	Trasparent	Trasparent	Trasparent
Hardness	85 Sh A	70 Sh A	80 Sh A
Standard thickness (mm)	2	2 - 3 - 4 - 5	5
Pulley multiplier C_D	30	25	30
Max working temperature (°C)	85	80	80
Mechanical characteristics	High coefficient of friction, high abrasion and wear resistance	High coefficient of friction, high abrasion and wear resistance	High coefficient of friction, high abrasion and wear resistance
Chemical properties	Good resistance to oils and greases	Good resistance to oils and greases	Good resistance to oils and greases

Polyurethane foam backings

Polyurethane foams are easily compressible according to the cellular structure of the material. Due to this main characteristic, common applications are: labelling equipment, light and/or fragile materials conveying, glass and paper industry, vacuum conveyors.

Pulley diameter: C_D • Backing Thickness

	PU YELLOW	CELLOFLEX
Material	Polyurethane	Polyurethane foam
Color	Yellow	Beige
Hardness	55 Sh A	-
Standard thickness (mm)	2 - 3 - 4 - 5	2 - 4 - 6 - 8 - 10
Pulley multiplier C_D	20	6
Max working temperature (°C)	60	80
Mechanical characteristics	Good wear resistance	High flexibility and high coefficient of friction
Chemical properties	Moderate resistance to oils and greases	Moderate resistance to oils and greases

PVC backings

PVC has a high coefficient of friction and a good resistance to acids. Due to its versatility, it is used in many applications in the paper, glass, ceramic industry, labelling and packing equipment. FDA quality allows the application in food industry processes.

Pulley diameter: $C_D \cdot$ Backing Thickness

	SUPERGRIP	FISHBONE	PVC BLUE/WHITE
Material	PVC	PVC	PVC
Color	Green / Blue	White	Blue / White
Hardness	ca. 30 Sh A	40 Sh A	ca. 40 Sh A
Standard thickness (mm)	4	ca. 4	1 - 2 - 3
Pulley multiplier C_D	16	26	18
Max working temperature (°C)	60	80	80
Mechanical characteristics	High coefficient of friction	Good wear resistance, high coefficient of friction	Good wear resistance, high coefficient of friction
Chemical properties	Good resistance to oils and greases	FDA approved, good resistance to oils and greases	Good resistance to oils and greases. White type is FDA approved.

Rubber backing

Many different rubber backings in both synthetic and natural rubber are available. Due to rubber high friction coefficient and high temperature resistance, ELATECH® polyurethane belt with rubber backing are used in many different conveying application: paper industry, ceramic industry, wood processing industry, glass industry, labelling and packaging machines.

Pulley diameter: C_D • Backing Thickness

	LINATEX	POROL	ISOGUM
Material	Natural rubber	Cellular rubber	Natural rubber
Color	Red	Black	Red
Hardness (Sh A) - Density (g/dm ³)	ca. 38 Sh A	ca. 190 g/dm ³	ca. 40 Sh A
Standard thickness (mm)	1,6 - 2,4 - 3,2 - 4,8 - 6,4 - 10	ca. 4	2 - 3 - 4 - 6 - 10 - 12
Pulley multiplier C_D	15	6	18
Max working temperature (°C)	60	60	60
Mechanical characteristics	Hight coefficient of friction, very good resistance to cut and tear	Good wear and tear resistance, high coefficient of friction	Truly endless backing which guarantee long belt life. Hight coefficient of friction, very good resistance to cut and tear
Chemical properties	Good resistance to oils	Good resistance to non aggressive oils	Good resistance to oils

Speciality

Pulley diameter: C_D • Backing Thickness

	TECNOGUM	SYLOMER	VITON
Material	Termoplastic rubber compound	PUR	Fluoroelastomer
Color	Red - White	Blue - Green - Brown	Black
Hardness (Sh A) - Density (g/dm ³)	ca. 60 Sh A	220 - 300 - 400	ca. 75 Sh A
Standard thickness (mm)	2 - 3 - 4 - 6	3 → 25	2 - 4 - 5 - 6
Pulley multiplier C_D	20	13	18
Max working temperature (°C)	80	70	250
Mechanical characteristics	Hight coefficient of friction, very good resistance to cut and tear weldable	Good wear resistance, high coefficient of friction	High temperature resistance
Chemical properties	Very good resistance to oils	Resistance to some oils and greases	Good resistance to oils and greases.

More types of backing are available. Please consult with our technical department.

ELATECH® EMF - Mechanical Fastening System

(patent pending)

ELATECH® EMF - Mechanical Fastening System allows in many conveying applications cost savings associated with being able to design equipment around the installation principle of EMF.

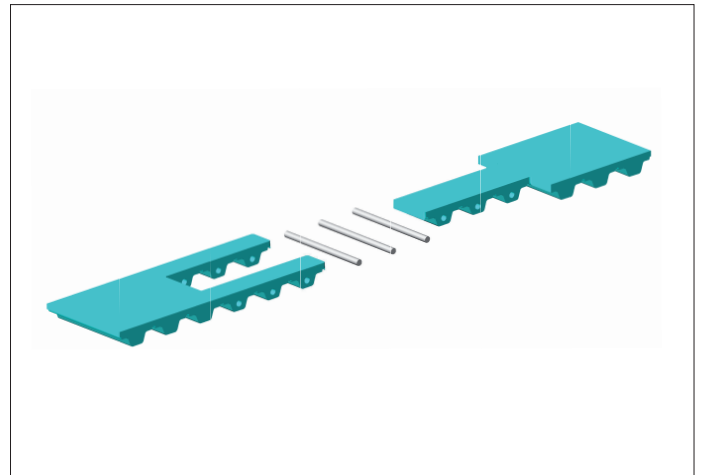
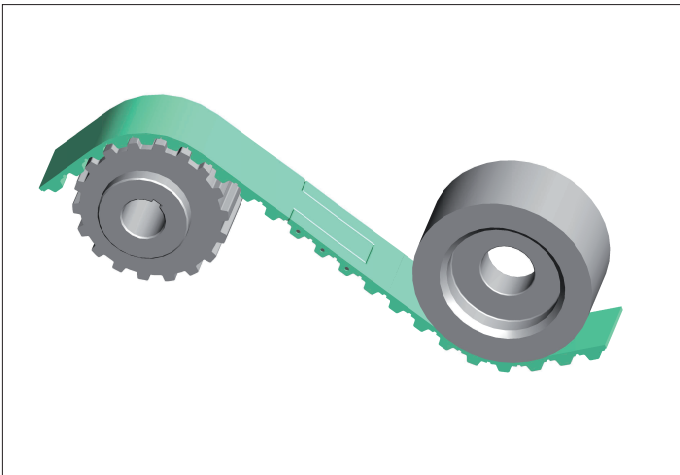

Features

- EMF has no exposed metal parts, therefore no metal contact is made with pulleys, so it runs very quiet. Since there are no exposed metal parts, EMF will not damage conveyed products like competing metal based mechanical fastening alternatives.
- EMF maintains the same minimum pulley requirements as the belt and can operate with back bend idlers.
- It is excellent for belt applications with special backings such as Linatex, Supergrip, PVC, Fishbone, etc. EMF fits snug, which eliminates gaps otherwise seen in competing designs.
- It is suitable for belts with profiles for quick installation, saving time and money.
- EMF installs in seconds, making it the fastest timing belt installation for product conveyance. There is no need for time-consuming field welding.
- It is simple to install and requires no cumbersome or expensive field welding equipment.
- It can be custom designed according to the application strength needed. EMF can reach the same strength as the traditional welding.
- It is available on all pitches, making it a "must have" for all of your customer's conveying applications.

ELATECH® polyurethane belts with profiles

It is possible to attach profiles on all ELATECH® and ELA-flex SD™ polyurethane belts for conveying, handling and positioning applications. The cleats are produced in the same material of the belts in order to guarantee the maximum strength. The belts with profiles allow a synchronised translation of the products at very high speeds and low noise. A very wide range of profiles is available. If the required profile is not shown in the following pages, please contact with our technical office.



Arc of contact

It is to be noted that the belt's arc of contact may be restricted by the jointed profile. It is therefore recommended to select profiles with the minimum allowable thickness "U".

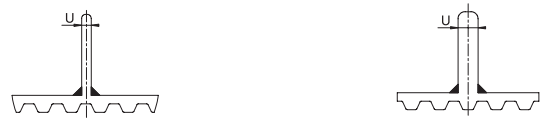

Pitch

It is recommended to choose the pitch of the profile corresponding to the belt profile or multiple. This allows to minimize the effects of the belt overall length tolerance on profile spacing.

Position

Profiles position may be over the tooth or not over the tooth. Belt Flexibility is maximised when the profiles are applied over the tooth.

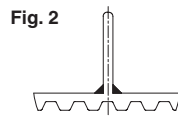
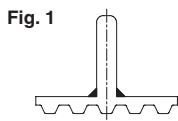

Tolerances

The tolerance of position of the profiles is +/- 0,5 mm. If required it is possible to reduce the tolerance down to +/- 0,2 mm with an extra machining. During the welding process a bead of polyurethane of about 0,5-1 mm develops at the meeting point between the profile and the belt. Should it be necessary for the application, it is possible to remove it with a mechanical machining.

Belt type	Profile thickness "U" (mm)																							
	2	3	5	6	8	10	12	14	16	20	25	30												
	Recommended minimum pulley number of teeth z																							
T5	14	20	14	30	20	45	25	50	40	60	60	100	80	100										
T10	16	20	16	20	16	30	16	40	20	50	25	50	35	60	50	70	80	80	100	100	120	120		
T20	20	20	18	20	18	25	18	40	18	50	20	50	25	50	30	60	40	60	50	60	70	80		
AT5	12	20	12	30	20	45	25	50	40	60	60	100	80	100										
AT10	18	20	18	20	18	30	18	40	20	50	25	50	35	60	50	70	80	80	100	100	120	120		
AT20	20	20	20	20	20	25	20	40	20	50	20	50	25	50	30	60	40	50	50	60	70	80	100	100
XL	10	20	10	30	20	45	25	50	40	60	50	100	60	100										
L	12	16	12	20	12	40	20	50	30	60	40	60	50	70	60	80	100	100						
H	14	16	14	16	14	25	14	30	20	50	25	50	40	60	50	70	80	80	100	100	120	120		
XH	18	18	18	20	18	20	18	30	18	40	20	50	20	50	25	55	35	60	50	60	70	80		
HTD5M	12	20	12	30	20	45	25	50	40	60	60	100	80	100										
HTD8M	18	18	18	18	18	24	18	32	18	40	20	40	28	48	40	56	64	64	80	80	100	100		
HTD14M	28	28	28	28	28	28	28	40	28	50	28	50	28	50	30	60	40	50	50	60	100	100	110	110
STD5M	12	20	12	30	20	45	25	50	40	60	60	100	80	100										
STD8M	18	18	18	18	18	24	18	32	18	40	20	40	28	48	40	56	64	64	80	80	100	100		

Minimum number of teeth when the profile is welded on tooth gap (fig. 2)
 Minimum number of teeth when the profile is welded on tooth (fig. 1)

Ordering

When ordering it is necessary to indicate: type of belt (width, profile, pitch, length), the belt length in number of teeth, the belt and profile drawing with the number and the pitch of the requested profiles

Special execution

On demand it is possible to produce special belts with special machining both on the teeth and on the back of the belt.

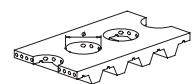
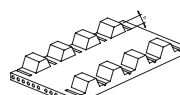
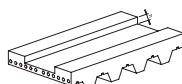
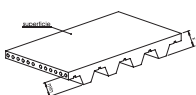

ELATECH® EFT - Mechanical Profile System

EFT is ELATECH's mechanical profile application system specially designed for attaching cleats that cannot be welded onto polyurethane timing belts.

It is offered in zinc-coated or stainless steel teeth with either our embedded tooth or total tooth design. The total tooth design replaces the entire tooth of the belt and has two securing threaded holes. The embedded tooth design eliminates metal-to-metal contact, making this a more quiet solution.

Total tooth design

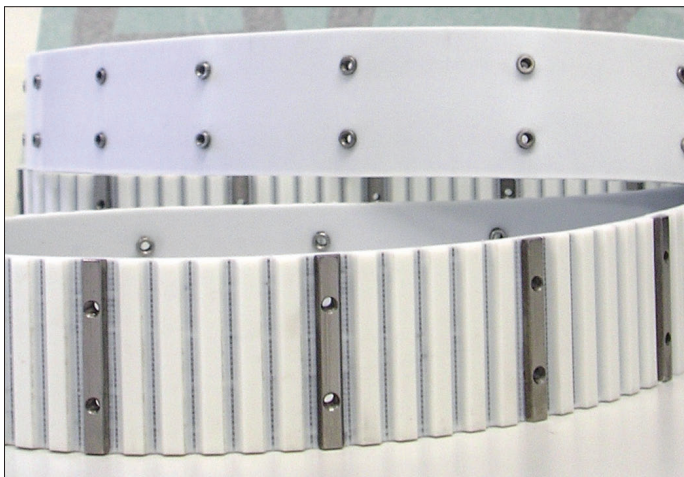

Embedded tooth design

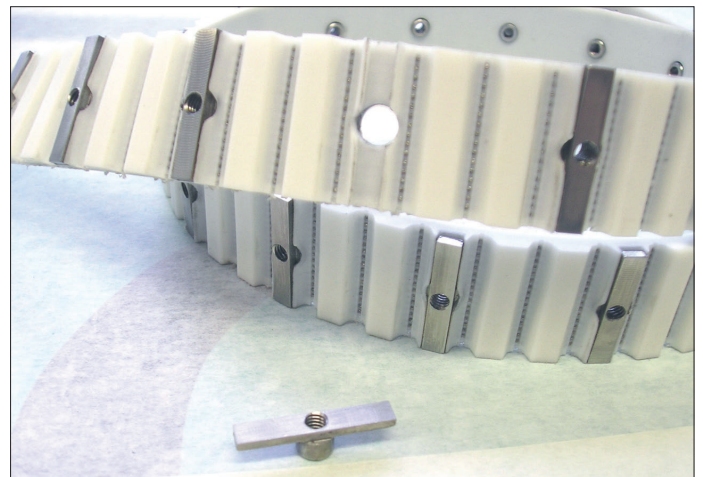

Features

- A self-centering effect on profile positioning, which makes it more precise than welded profiles.
- Can handle much higher loads than welded profiles, making it a strong solution.
- It is the precise solution eliminating any welded profile positioning tolerances. The profile positioning tolerance for EFT mirrors the ELATECH® timing belt tooth pitch tolerance.
- It is versatile, allowing customers to attach cleats made of steel, stainless steel, plastic, urethane, wood, or virtually any other material.
- It is flexible, allowing customers to reposition cleats for regularly scheduled application changes.
- It is economical because customers can replace worn profiles without replacing the entire belt.
- It is available in any of the following pitches: AT10, ATK10, AT20, H, XH.

ELATECH® EFT typical applications:

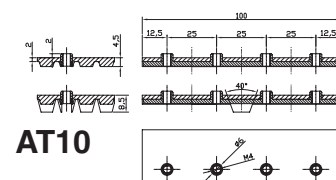
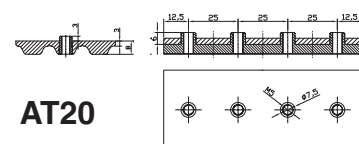
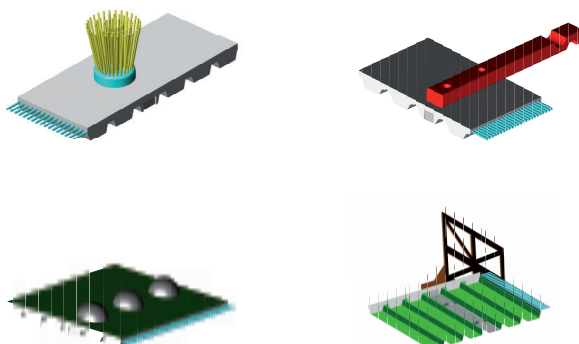

PROFILES

ELATECH® offers a wide range of profiles. Some configurations are shown in the following pages.
For all other shapes needed, please contact our technical office.

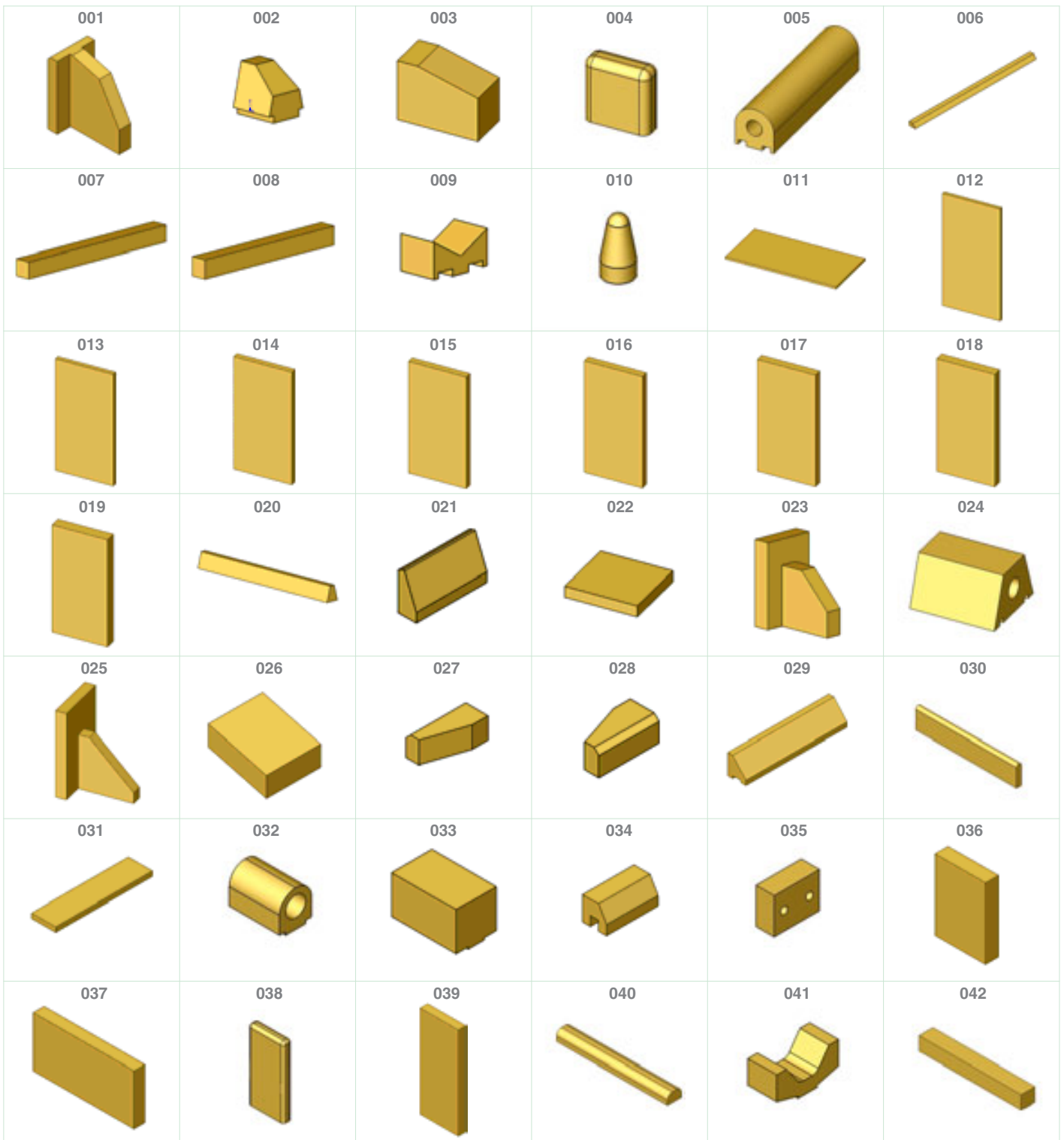

043 	044 	045 	046 	047 	048
049 	050 	051 	052 	053 	054
055 	056 	057 	058 	059 	060
061 	062 	063 	064 	065 	066
067 	068 	069 	070 	071 	072
073 	074 	075 	076 	077 	078
079 	080 	081 	082 	083 	084

085 	086 	087 	088 	089 	090
091 	092 	093 	094 	095 	096
097 	098 	099 	100 	101 	102
103 	104 	105 	106 	107 	108
109 	110 	111 	112 	113 	114
115 	116 	117 	118 	119 	120
121 	122 	123 	124 	125 	126

127 	128 	129 	130 	131 	132 
133 	134 	135 	136 	137 	138 
139 	140 	141 	142 	143 	144 
145 	146 	147 	148 	149 	150 
151 	152 				

Material characteristics

Elatech belts are manufactured as standard in thermoplastic polyurethane 92 Sh. A hardness. Non standard material and compounds are available for applications in special environments or in respect of special specifications. Standard colour, unless differently specified, is white. Other colours are available upon request.

Resistance to oils

ELATECH® polyurethane has an high resistance to most oils. The following graph compares synthetic rubber CR and NBR with ELATECH® polyurethane

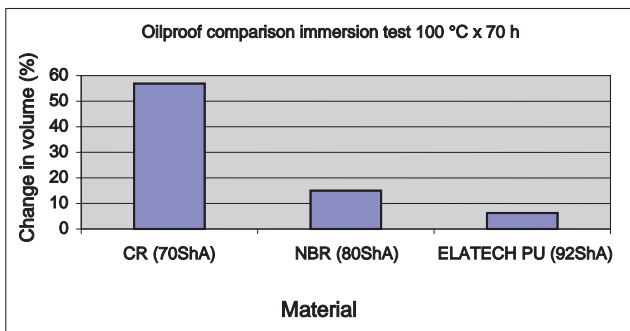

Abrasion resistance

ELATECH® polyurethane has excellent abrasion resistance properties. The graph below shows comparison with synthetic rubber.

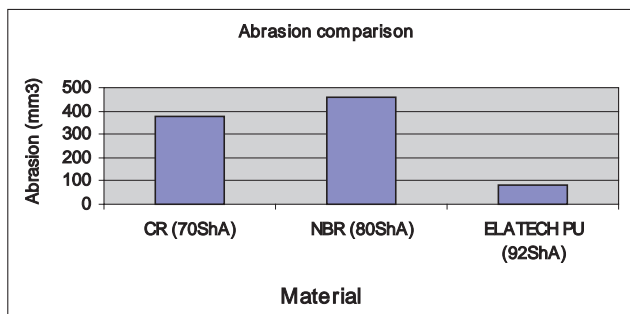

FDA/USDA approval

Standard material is not FDA approved. For applications where FDA approval is required, a special material will be used. The standard color of the FDA material is transparent.

Chemical resistance

The impact of chemicals on ELATECH® polyurethane results in different modification of the material's properties. As the resistance mainly depends on the concentration and the temperatures used, the information provided can only be general. If further detailed information is required please contact with our technical department.

Oil and Grease

ELATECH® polyurethane is well-resistant to oil and grease and specifically to pure oils even at 80°C.

Acids and alkaline solutions

The resistance to acids and alkaline solutions of the ELATECH® polyurethane is limited. It has shown to be moderate resistant to diluted acids and alkaline solutions at room temperature and to be resistant for a very a short time with high concentration solutions. Special compounds are available on specific request.

Bacteria and microbes

In case of high exposure to microbe attack it is recommended to use a special material. Please contact with our technical department.

UV resistance

ELATECH® polyurethane is UV resistant. A long exposure to UV radiation (sunlight) will have as an effect to slightly change the color of the belt. However the technical performances of the product will remain unchanged.

Chemical resistance

CHEMICAL REFERENCE	0/40° C	40/80° C
Acetic acid	B	C
Acetic acid 3 n	C	C
Acetic acid, 20 %	B	C
Acetone	C	C
Acetone	B	-
AL-chloride, aqueous, 5 %	A	-
Ammonia, 10 %	A	-
Amyl acetate	C	C
Aniline	B	C
ASTM Fuel A	A	-
ASTM Fuel B	A	-
ASTM Fuel C	B	-
ASTM oil 1	A	A
ASTM oil 2	A	A
ASTM oil 3	A	A
Baking Soda	A	-
Benzene	B	C
Benzine	B	C
Bleaching agent	A	A
Blood	A	B
Brine	A	B
Buthyl alcohol (Butanol)	B	B
Butric acid	B	B
Butter	A	A
Butylacetate	C	-
Carbon tetrachloride	C	C
Chloro benzene	C	C
Chloroform	B	B
Cyclohexanol	B	B
Cyclohexanone	C	C
Dibutylphthalate	B	-
Diesel oil	A	-
Dimethylformamide	D	D
Diocyl phthalate	A	A
Dye	B	B
Ethanol 96 %	B	-
Ethyl acetate	C	C
Ethyl alcohol (Ethanol)	B	C
Ethylacetate	C	C
Ethylene dichloride	B	B
Ethylene glycol	A	B
Ethylene glycol acetate	B	C
Ethylether	C	-
Fat (animal)	A	A
Fe chloride, aqueous, 5 %	B	C
Formalin	B	C
Freon 22	B	C
Fructose	A	A
Fruit juice	A	A
Gasoline	B	C
Gelatin	A	A
Glycerin (Glycerol)	B	C
Glycol	A	B
Glycantin / water 1:1	A	B
Honey	A	B
Hydrochloric acid, 20 %	B	-

Note

• The above table is valid for material to be conveyed containing chemicals and or oil. In case of immersion, please contact with our technical department.

• It must be considered that alkalis, acids, peroxides, water and water solutions may corrode the steel tension member. In case, please contact our technical department for solutions.

CHEMICAL REFERENCE	0/40° C	40/80° C
Hydrogen	A	-
Ink	B	B
Isopropanol	B	-
Kerosene	A	B
Lactic acid	B	C
Liqueur	A	B
Margarine	A	A
Methyl alcohol (Methanol)	B	C
Methyl ethyl ketone (MEK)	C	C
Methylen chloride	D	-
Milk	A	A
Mineral oil	A	B
Molasses	A	A
Nicotine	A	-
Nitric acid, 20 %	D	-
Oil animal	B	B
Oil heavy	A	B
Oil light	A	B
Oil Machine	B	B
Oil tar	B	B
Oil turpentine	B	B
Oil vegetable (peanut, pine, soy, sunflower)	A	A
Oleic acid	B	-
Ozone	A	A
Paraffin	B	B
Petrol, premium grade	C	-
Petrol, standard grade	A	-
Petroleum ether	B	C
Salt	A	A
Sea water	A	B
Silicone grease	A	A
Soap	A	B
Soda soap fat	A	B
Sodium chloride solution, conc.	A	B
Sodium hydroxide solution 1N	B	B
Starch	A	A
Strong acid (pH3)	B	C
Strong alkali (pH11-14)	B	C
Styrene	B	C
Sugar	A	A
Sulphuric acid, 20 %	B	-
Tannic acid	A	B
Tannic acid	A	A
Toluene	B	C
trichloroethylene	C	C
Triocresyl phosphate	B	C
Vaseline	A	A
Vinegar	B	C
Water	A	B
Water oxygenated	B	B
Water salt	A	B
Water soapy	A	B
Wax	A	A
Weak acid (pH4)	B	B
Weak alkali (pH10-11)	B	B
Yeast	A	B

A = resistant over a prolonged period

B = conditionally resistant, after a certain time appreciable differences are possible

C = not resistant, short-term contact possible

D = not resistant, pronounced attack

Troubleshooting

DAMAGE	CAUSE	REMEDY
Belt tooth jumping	<ul style="list-style-type: none"> Over load (shock on the machine) Overload due to machine accident Shortage of teeth in mesh Lack of initial tension Pulley diameter too small Moment of inertia for start and stop is not considered 	<ul style="list-style-type: none"> Increase belt size/modify design Prevent reoccur of the accident Increase teeth in mesh by using an idler Correct initial tension Change design Change design
Abnormal noise level	<ul style="list-style-type: none"> Bad pulley alignment Incorrect pulley tooth shape Belt wider than pulley diameter Over load Belt over-tension 	<ul style="list-style-type: none"> Adjust alignment Change pulley Change design Change design Correct initial tension
Belt side abrasion	<ul style="list-style-type: none"> Bad pulley alignment Poor flange shape Pulley flange roughness 	<ul style="list-style-type: none"> Adjust alignment Correct flange bending or change flange Change flange to an appropriate one
Belt tooth abrasion	<ul style="list-style-type: none"> Presence of particles between belt and pulley Over load Over tension Belt tooth jumping due to lack of initial tension 	<ul style="list-style-type: none"> Improve environment or apply a protective cover Change design (increase belt size) Correct initial tension Correct initial tension
Belt tooth bottom abrasion	<ul style="list-style-type: none"> Bad pulley profile Over tension 	<ul style="list-style-type: none"> Use correct pulley Correct initial tension
Belt back abrasion	Contact with undesired element (i.e. machine frame)	Eliminate contact
Belt back cracking	<ul style="list-style-type: none"> Running under too low temperature Pulleys too small 	<ul style="list-style-type: none"> Increase environment temperature or ask for special compound Observe minimum pulley diameter recommendations
Belt breakage	<ul style="list-style-type: none"> Over load (shock on the machine) Undesired particles in mesh Tension member corrosion Belt run off over pulley flange Not enough belt teeth in clamping plate Clamping plate screws tightened incorrectly 	<ul style="list-style-type: none"> Increase belt size/modify design Improve environment or apply a protective cover Improve environment or use aramid/stainless steel cords Adjust alignment and change pulley flange Use larger clamping plate Apply optimum torque to clamp plate screws
Tension member partial tear	<ul style="list-style-type: none"> Presence of undesired particles in mesh Improper installation Belt folded or twisted Fatigue on side due to bad alignment 	<ul style="list-style-type: none"> Improve environment or apply a protective cover Pay care when installing Pay care in handling Correct alignment
Back covering abnormal abrasion	Aggressive environment	Change belt back cover or improve environment conditions
Pulley tooth abrasion	<ul style="list-style-type: none"> Presence of undesired particles in mesh Over load Belt over tension Pulley material not adequate (too soft) 	<ul style="list-style-type: none"> Improve environment or apply a protective cover Change design Correct initial tension Change pulley material or adopt surface treatment

